



## 2019 POLYURETHANE & PVC CATALOG

INCLUDES POLYURETHANE, PVC COLUMN WRAPS AND QUICKRAIL SYSTEMS





Style, Performance, Service. That's the Fypon® advantage.

## FYPON STYLE

Fypon is the recognized leader in polyurethane product design, innovation and molding technology. We offer a wide selection of architecturally correct styles and designs of moulding and trim. Fypon products are designed to capture the texture, patterns and deep shadow lines of classic building materials, adding a distinctive look and personality to any home.

## FYPON PERFORMANCE

Manufactured by experts in polyurethane molding technology, each Fypon product is engineered for consistent quality and long-lasting performance.

Fypon polyurethane products are low maintenance and easy to install, with no special tools or extra labor required. They are insect- and moisture-resistant, and won't warp, crack, split or rot.

## FYPON SERVICE

Building professionals trust Fypon to deliver outstanding customer service and support.

We provide:

- Drawings and marketing support for blueprints and model homes.
- An industry-first quote package program with quantity pricing tool.
- Support from Fypon experts and answers to common installation questions.
- Custom design services for historical restorations, replicas or any unique profile that fits your home or commercial application.

For more information, contact [CPS@fypon.com](mailto:CPS@fypon.com).



## UNDERSTANDING THE FYPON CATALOG AND PRODUCTS

Fypon offers a unique way to add distinction to your project with historically accurate products that bring out the best of any home.

In this catalog, you will find:

- Sizing for each part – height, width, length and projection.
- Detailed drawings.
- Part numbers.
- Inspirational images that showcase the various ways our products can be used.



## CUTTING & MILLING

Fypon polyurethane products can be cut and trimmed with standard woodworking tools, including table saws, circular saws, jig saws, band saws and miter saws. Trimming product will remove the smooth finish and create an exposed polyurethane edge. This edge must be finished with paint or stain to protect the exposed polyurethane from discoloration from the sun.

For more information on the installation and care of Fypon products, visit [fypon.com](http://fypon.com).

## CUSTOM / TAKEOFF

Fypon offers architects and builders custom design services for historical restorations, replicas and other applications. Our design experts will provide a customized takeoff plan specific to your project, complete with part numbers and list prices. For more information, contact [CPS@fypon.com](mailto:CPS@fypon.com) or call 1.855.397.6647.





# Contents

2019 Polyurethane & PVC Products

## 12 Window & Door Trim

- Crossheads & Pediments
- Pilasters
- Window & Door Trim
- Shutters
- Board & Louvered Panels



## 78 Mouldings

- Smooth Flat Trim
- Timber Flat Trim
- Mouldings
- Moulding Accessories
- Crown E-Vent



## 118 Decorative Millwork

- Brackets, Corbels & Dentil Blocks
- Knee Braces & Rafter Tails
- Gable Pediments
- Beams
- Beam Accessories
- Beam Mantels
- Tile Vents
- Trellis System



## 180 Louvers & Gable Vents

- Decorative Louvers
- Functional Louvers
- Louver Trim



## 198 Balustrade Systems, Porch Posts & Columns

- Balustrade Systems
- Structural Column
- Structural Porch Posts
- Post Wrap
- Stone Balustrade
- Stone Half-Round Column



## 224 Column Wraps

- ProSelect Square Column Wraps
- PremiumSelect Square Column Wraps
- Square Cap & Base Accessories
- PremiumSelect Tapered Column Wraps
- Tapered Cap & Base Accessories
- Structural Post

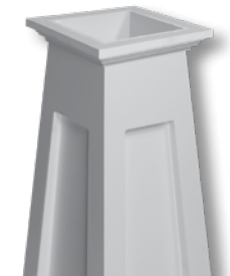

## 238 QuickRail® Systems

- Straight & Stair Rail Kits
- Complete Post Kits
- Post Sleeves
- Gate Kits
- Accessories



# ELEVATE 2019

Humble Roots | CONFIDENT FOCUS | TIMELESS TWIST

## Celebrate style with our new products.

As homeowners focus on bringing their own personal style to life, Fypon is elevating its product portfolio. We've researched the latest home design trends to offer you an on-trend product assortment.

The Humble Roots trend is grounded in casual living and is brought to life in homes that embrace architectural authenticity. These homes often feature simple, clean design details that incorporate natural textures, dimensional patterns and a softened industrial vibe.

The Confident Focus trend is tied to visually inspired spaces with striking contrasts that have an undercurrent of excitement while still maintaining a sense of calm. Home styles that coordinate with this trend often feature vertical windows, pops of color, geometric styling and mixed materials, inside and out.

The Timeless Twist trend is centered on the reinvention of classics mixed with 21st century living. These homes often have tailored design elements that add character and feature classic patterns and deep, dramatic color palettes to bring an understated sophistication to the home.

*Humble Roots*  
RELAXED | NATURAL | SIMPLE



Unplugged Lifestyles  
Love of Local  
Informal Surroundings



Casual and comfortable  
with a clean edge.

CONFIDENT FOCUS  
BOLD | INDIVIDUAL | EVOLVING





Modern design with a soft,  
livable touch.



Confident Creativity  
Visually Inspired  
Touching Senses

TIMELESS TWIST  
CHARMING | YOUTHFUL | TAILORED



Heritage Values  
New Traditions  
21st Century Style



A fresh, playful twist on traditional.



# 2019 New Products

## DISTINCTION CROSSHEAD OPTIONS

Discover expanded style options for our Distinction Crosshead, now available to add an updated look to timeless design. Dentil and Bottom Trim are offered in both Ready-to-Install and Trimmable options.



## CRAFTSMAN COVE CROSSHEAD

Our new Craftsman Cove Crosshead captures the look of a wood built-up Crosshead with Cove, Top and Bottom Trim. Optional End Caps are available to add an authentic Arts & Crafts style.



## CRAFTSMAN STEP CROSSHEAD

The simplistic design of our Craftsman Step Crosshead emphasizes the elements of early Craftsman-style homes.

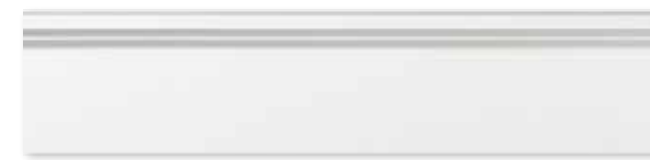



# 2019 New Products



## MODERN FARMHOUSE SHAKER-STYLE SHUTTERS

Discover casual, practical design with a modern twist. Our new Modern Farmhouse Shaker-style Shutters deliver an authentic look with subtle elegance.



## SHAKER-STYLE SHUTTERS

Add grace and charm to any home with our new Shaker-style Shutters. The 2-flat recessed panel stile and rail construction honors the timeless architectural details of both classic and modern Craftsman-style homes.



## RAFTER TAILS

New Fypon® Rafter Tails feature an updated Rough Sawn Cedar finish, offering a more authentic look. Choose from five new profile designs including Straight, Cove, Slant, Bullnose and Scroll.



## BEAM MANTELS AND SHELVES

Add rustic charm to the interior of any home with Fypon Beam Mantels and Shelves. Choose from two realistic wood grains, Rough Sawn or Hand Hewn.



# Window & Door Trim



Crossheads .....	16
Pediments .....	34
Pilasters .....	43
Trim .....	48
Window Panels .....	52
Keystones .....	53
Door Surround Kits.....	54
Smooth Shutters .....	58
Timber Shutters .....	62

## An unforgettable first impression.

Transform the look of any home with Fypon® Window and Door Trim. Designed to work together, these pieces are quick and easy to install.

### Product Shown:

Craftsman Step Crosshead – CHCST144X8  
Square Column Wrap – ProSelect CWPR12X72SFT  
Shutters – SH2FP18X60  
Gable Pediment – GP66X33  
Sill Moulding – MLD710-10  
Flat Trim – FLT110-16  
Bracket – BKT15X18X6





# Window & Door Trim

## How to Use This Section

Where applicable, part numbers are shown for products with attached accessories, or other available unattached accessories are referenced or shown with the product.

## How to Order

### Door Trim & Entrance Systems

When ordering door trim, first measure the door unit to be trimmed. The unit can be measured with or without brickmould; however the brickmould is essential when using a storm door. Next, choose the desired Pilaster style and size. Finally, choose a Pediment or Crosshead that is wide enough to span the opening plus the brickmould and Pilasters. Add desired accessories to complete the look.

### Window & Door Trim Accessories

Keystones, Dentil Trim, Trim Strip and Bottom Trim accessories are available attached to standard products as fabricated products. A Keystone can also be ordered as an unattached accessory.

### Remember to Order Adhesive

A urethane-based adhesive **must** be used on all joint surfaces. See page 252 to order Loctite® PL Premium® Adhesive.\*



\*Loctite® PL Premium® is owned by Henkel IP & Holding GmbH. Always consult the local building code authority to determine suitability of products to meet specific project requirements. Images are representative of style, actual product will vary by size.

## Window & Door Trim Applications

### Distinction Crosshead with End Caps

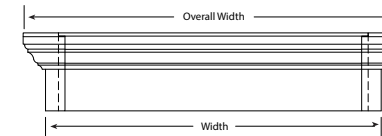

### Craftsman Cove Crosshead with End Caps



### Without Accessories

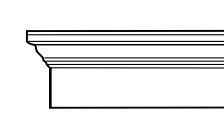

### With Accessories

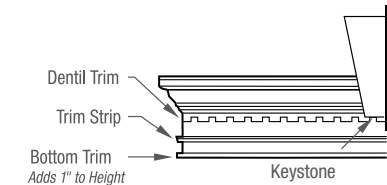

Note: A Keystone cannot be used when combining a crosshead with a Pediment.

### Window Trim Terminology

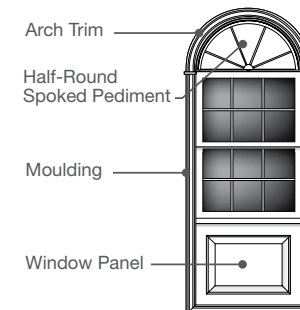

### Keystone Options



### Crosshead Options for Entry Way

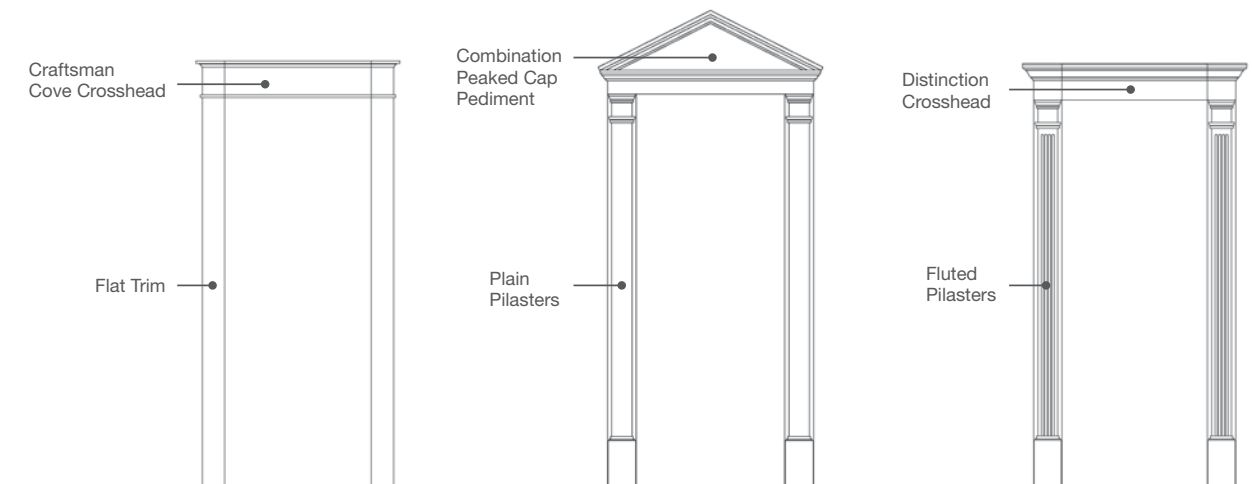



# DISTINCTION CROSSHEAD



## Ready-to-Install

- Our extended Distinction Crosshead line includes heights measuring 6" and 9". Widths for 6" high Crossheads are available from 24" - 144", and widths for 9" Crossheads are available from 24" - 216", both in 1" increments.
- End Cap comes standard with 1 1/2" width and overlaps Crosshead.



## 6" & 9" Distinction Crosshead

Ready-to-Install

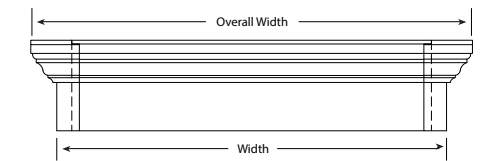

Part Number Logic:

**CH24X6EC**

<p><b>[Profile]</b> CH = Crosshead</p>	<p><b>[Configuration]</b> EC = End Cap BT = Bottom Trim D = Dentil Trim K = Keystone R = Routed</p>	<p><b>[Breast Board Width]</b> (1" increments) 24 = 24" [Minimum] 144 = 24" [Maximum for 6" high] 216 = 216" [Maximum for 9" high]</p>	<p><b>[Height]</b> 6 = 6" 7 = 7" (BT option only) 9 = 9" 10 = 10" (BT option only)</p>
--	---	--	--

## Distinction Crosshead with Coordinating Pilaster Widths

Ready-to-Install

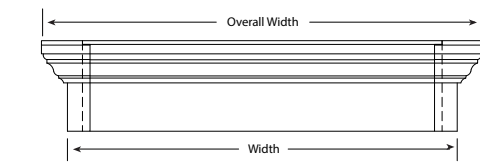

Part Number Logic:

**CH51X6EC5**

<p><b>[Profile]</b> CH = Crosshead</p>	<p><b>[Pilaster Width*]</b> 5 = 5 1/4" 7 = 7" 9 = 9"</p>	<p><b>[Crosshead Width]</b> 51 = 51"   66 = 66"   74 = 74"   86 = 86" 53 = 53"   67 = 67"   77 = 77"   88 = 88" 54 = 54"   68 = 68"   78 = 78"   93 = 93" 56 = 56"   69 = 69"   80 = 80"   96 = 96" 58 = 58"   70 = 70"   81 = 81" 64 = 64"   72 = 72"   84 = 84"</p>	<p><b>[Crosshead Height]</b> 6 = 6" 9 = 9"</p>
--	--	---	--

EC = End Cap

If Pilasters are to be included as part of the opening, remember the following:

- 1) Remember to account for lighting, door bells, mailboxes or any other item that could dictate the width of the Pilaster.
- 2) Don't forget to take into account brickmould, if applicable
- 3) Breast board of Crosshead should fit over the entire width of the right and left Pilasters.

\* The last character in the part number coordinates with the Pilaster width.

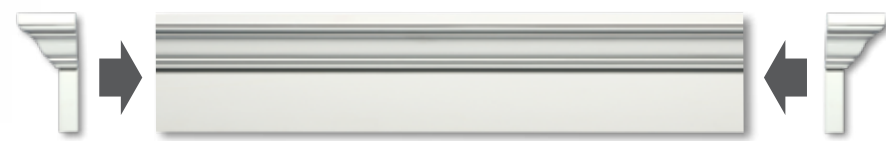

**How to Order**

**Example**

- 1 Determine height.
- 2 Determine breast board width of Crosshead.
- 3 Select End Cap width. End Cap widths should coordinate with Pilaster or Moulding on either side of door / window. If no Moulding is used, then any End Cap can be selected.
- 4 Calculate Trimmable Crosshead; account for End Cap. Crosshead breast board width - (End Cap Back Surface X 2) = Trimmable Crosshead
- 5 Select Trimmable Crosshead.
- 6 Optional: Select Accessory Moulding / Keystone.

6" high  
 36" width  
 CHC4X6 (Coordinating over 3 1/2" Flat Trim)  
 36" - (2.5" x 2) = 31" required\*  
 CHT36X6  
 K6M and MLD716-12

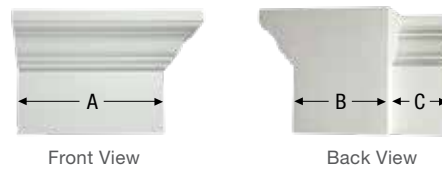

\*End Cap Back Surface

End Cap	End Cap Breast Width (A)	End Cap Back Surface (B)	Rabbet Width (C)
CHC2	1 1/2"	1"	1/2"
CHC4	3 1/2"	2 1/2"	1"
CHC7	7"	3"	4"
CHC11	11"	7"	4"

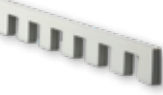

Note: Rabbet width overlaps Crosshead.

**Distinction Accessories**

Accessory	6" Height	9" Height
	Keystone K6M	K9M
	Dentil MLD357-8	MLD358-8
	Bottom Trim MLD716-12	MLD758-12

**Trimmable**

- Distinction Trimmable Crossheads are available in heights measuring 6" and 9", and widths measuring 36", 48", 144" and 216".
  - 36" and 48" widths allow for ease of handling and quick installation.
  - 144" and 216" widths can be cut to any length, minimizing waste in the field.
- End Cap overlaps the Trimmable Crosshead.
- End Cap may be routed.

**6" Distinction Crosshead & End Caps**

Trimmable

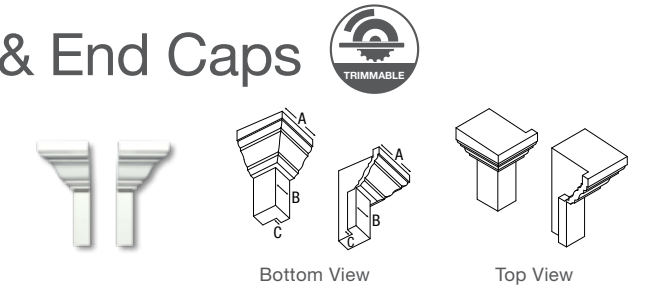

Part Number	Overall Width
CHT36X6	36"
CHT48X6	48"
CHT144X6	144 3/8"
CHT216X6	216 5/8"

Part Number	Overall Width (A)	Width (B)	Rabbet Width (C)
CHC2X6	3 1/4"	1 1/2"	1/2"
CHC2X6-5*			
CHC4X6	5 1/4"	3 1/2"	1"
CHC4X6-5*			
CHC7X6^	8 3/4"	7"	4"
CHC7X6-5*^			
CHC11X6^	12 3/4"	11"	4"
CHC11X6-5*^			

Note: Sold in pairs. \*Pack quantity of 5 pair. ^ Trimmable up to 3 1/2".

**9" Distinction Crosshead & End Caps**

Trimmable

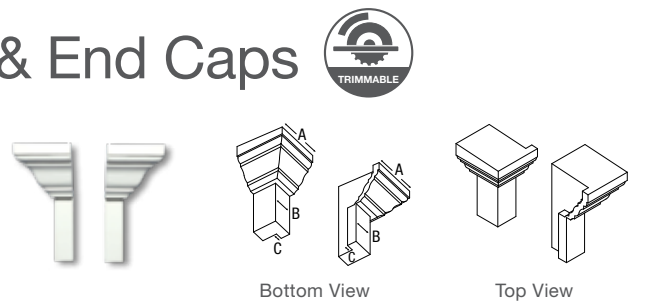
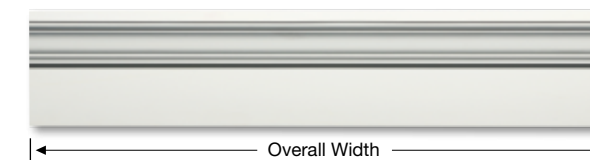

Part Number	Overall Width
CHT36X9	36"
CHT48X9	48"
CHT144X9	144 3/8"
CHT216X9	216 5/8"

Part Number	Overall Width (A)	Width (B)	Rabbet Width (C)
CHC2X9	4 1/4"	1 1/2"	1/2"
CHC2X9-5*			
CHC4X9	6 1/4"	3 1/2"	1"
CHC4X9-5*			
CHC7X9^	9 3/4"	7"	4"
CHC7X9-5*^			
CHC11X9^	13 3/4"	11"	4"
CHC11X9-5*^			

Note: Sold in pairs. \*Pack quantity of 5 pair. ^ Trimmable up to 3 1/2".





# CRAFTSMAN COVE CROSSHEAD

## Ready-to-Install

- Our expanded Craftsman Cove Crosshead line includes heights measuring 9" and widths measuring 24" - 216", available in 1" increments.
- End Cap comes standard with 3 1/2" width and overlaps Crosshead.
- End Cap may be routed.

## 9" Craftsman Cove Crosshead



### Part Number Logic:

**CHCC24X9BT**

<b>[Profile]</b> CHCC = Craftsman Cove Crosshead	<b>[Breast Board Width]</b> (1" increments) 24 = 24" [Minimum] 216 = 216" [Maximum]	<b>[Configuration]</b> EC = End Cap R = Routed  BT = Bottom Trim	<b>[Height]</b> 9 = 9"
---	--	--	---------------------------

If Flat Trim is to be included as part of the opening, remember the following:

- 1) Account for lighting, door bells, mailboxes or any other item that could dictate the width of the trim.
- 2) Don't forget to take into account brickmould, if applicable.
- 3) Breast board of the Crosshead or Crosshead End Cap should fit over both the left and right trim pieces.







## Trimmable

- Our expanded Craftsman Cove Crosshead line includes a 9" height, and widths measuring 24"-216", in 1" increments.
- End Cap comes standard with 3 1/2" width and overlaps Crosshead.
- Crosshead and End Caps may be routed.

## 9" Craftsman Cove Crosshead

Trimmable

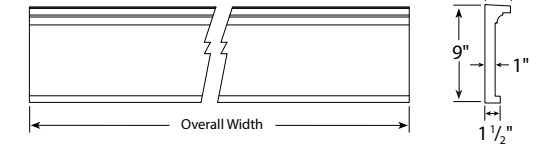

Part Number	Overall Width
CHCCT36X9BT	36"
CHCCT48X9BT	48"
CHCCT144X9BT	144"
CHCCT216X9BT	216"

End Caps are optional.

## How to Order

- 1 Determine height.
- 2 Determine Breast Board width. When installing over side trim CHCCC6X9BT coordinates best with 5 1/4" Pilaster and 5 1/2" wide trim.
- 3 Select End Cap width.



## 9" Craftsman Cove End Caps

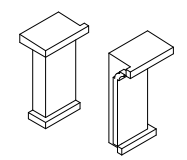
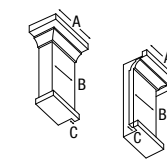

Part Number	Overall Width (A)	Width (B)	Rabbit Width (C)
CHCCC4X9BT	5"	3 1/2"	1/2"
CHCCC4X9BT-5*			
CHCCC6X9BT	7"	5 1/2"	1/2"
CHCCC6X9BT-5*			

\* Pack quantity of 5 pair.  
End Cap overlaps the Trimmable Crosshead.



# CRAFTSMAN STEP CROSSHEAD



## 6" Craftsman Step Crosshead



TrimMable

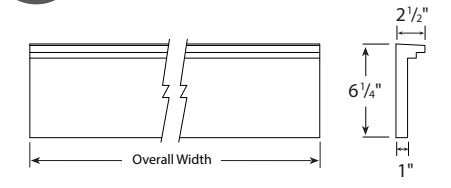

Part Number	Overall Width	Height
CHCST36X6	36"	6 1/4"
CHCST48X6	48"	6 1/4"
CHCST144X6	144 3/8"	6 1/4"
CHCST216X6	216 5/8"	6 1/4"

Part may be routed.

## 8" Craftsman Step Crosshead



TrimMable

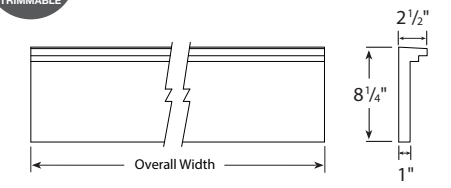

Part Number	Overall Width	Height
CHCST36X8	36"	8 1/4"
CHCST48X8	48"	8 1/4"
CHCST144X8	144 3/8"	8 1/4"
CHCST216X8	216 5/8"	8 1/4"

Part may be routed.

Parts may be required to ship LTL (less than truckload) based on size and overall dimensions.



**PRO TIP**  
Miter ends for a more traditional look.



# CLASSIC CROSSHEAD



## 6" Classic Crosshead

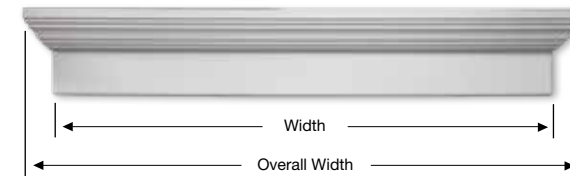

### Part Number Logic:

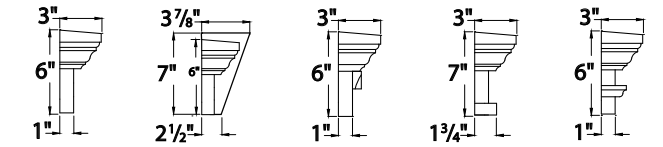
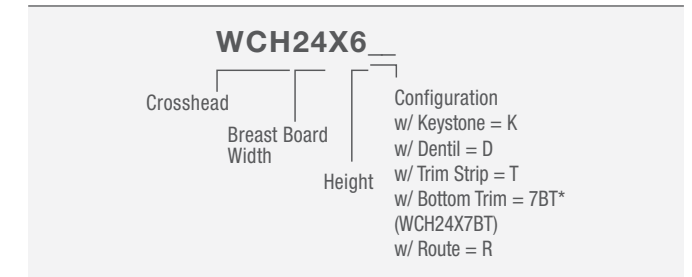

Standard w/ Keystone K6M^ w/ Dentil Trim w/ Bottom Trim w/ Trim Strip

\* Bottom trim adds 1" to overall height.

Part Number	Width	Overall Width
WCH24X6	24"	27 1/2"
WCH28X6	28"	31 1/2"
WCH30X6	30"	33 1/2"
WCH31X6	31"	34 1/2"
WCH32X6	32"	35 1/2"
WCH33X6	33"	36 1/2"
WCH34X6	34"	37 1/2"
WCH35X6	35"	38 1/2"
WCH36X6	36"	39 1/2"
WCH37X6	37"	40 1/2"
WCH38X6	38"	41 1/2"
WCH40X6	40"	43 1/2"
WCH41X6	41"	44 1/2"
WCH43X6	43"	46 1/2"
WCH44X6	44"	47 1/2"
WCH46X6	46"	49 1/2"
WCH47X6	47"	50 1/2"
WCH48X6	48"	51 1/2"
WCH50X6	50"	53 1/2"
WCH51X6	51"	54 1/2"
WCH52X6	52"	55 1/2"
WCH54X6	54"	57 1/2"
WCH56X6	56"	59 1/2"

Part Number	Width	Overall Width
WCH60X6	60"	63 1/2"
WCH64X6	64"	67 1/2"
WCH66X6	66"	69 1/2"
WCH67X6	67"	70 1/2"
WCH68X6	68"	71 1/2"
WCH72X6	72"	75 1/2"
WCH73X6	73"	76 1/2"
WCH74X6	74"	77 1/2"
WCH76X6	76"	79 1/2"
WCH78X6	78"	81 1/2"
WCH79X6	79"	82 1/2"
WCH80X6	80"	83 1/2"
WCH80.5X6	80 1/2"	84"
WCH84X6	84"	87 1/2"
WCH86X6	86"	89 1/2"
WCH87X6	87"	90 1/2"
WCH96X6	96"	99 1/2"
WCH100X6	100"	103 1/2"
WCH103X6	103"	106 1/2"
WCH104X6	104"	107 1/2"
WCH108X6	108"	111 1/2"
WCH110X6	110"	113 1/2"
WCH144X6	144"	147 1/2"



## 9" Classic Crosshead

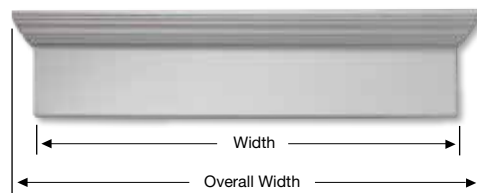

### Part Number Logic:

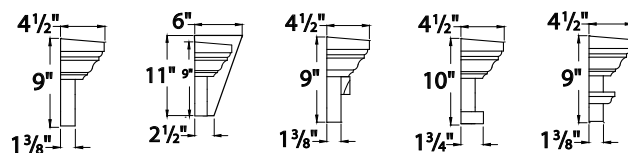
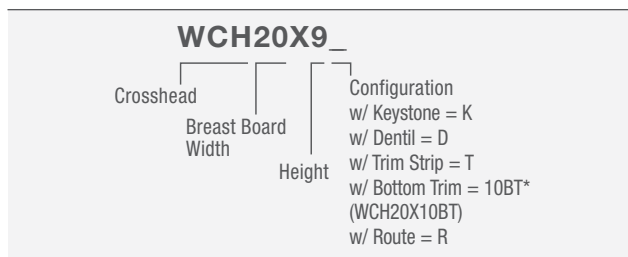

Standard w/ Keystone K9M^ w/ Dentil Trim w/ Bottom Trim w/ Trim Strip

\* Bottom trim adds 1" to overall height.

Part Number	Width	Overall Width
WCH20X9	20"	25 1/2"
WCH24X9	24"	29 1/2"
WCH25X9	25"	30 1/2"
WCH26X9	26"	31 1/2"
WCH27X9	27"	32 1/2"
WCH28X9	28"	33 1/2"
WCH29X9	29 5/8"	35 1/8"
WCH30X9	30 1/4"	35 3/4"
WCH32X9	32"	37 1/2"
WCH33X9	33"	38 1/2"
WCH34X9	34"	39 1/2"
WCH35X9	35"	40 1/2"
WCH36X9	36"	41 1/2"
WCH37X9	37"	42 1/2"
WCH38X9	38"	43 1/2"
WCH40X9	40"	45 1/2"
WCH41X9	41"	46 1/2"
WCH42X9	42"	47 1/2"
WCH43X9	43"	48 1/2"
WCH44X9	44"	49 1/2"
WCH45X9	45"	50 1/2"
WCH46X9	46"	51 1/2"
WCH48X9	48"	53 1/2"
WCH49X9	49"	54 1/2"
WCH50X9	50"	55 1/2"
WCH54X9	54"	59 1/2"

Part Number	Width	Overall Width
WCH56X9	56"	61 1/2"
WCH58X9	58"	63 1/2"
WCH60X9	60"	65 1/2"
WCH62X9	62"	67 1/2"
WCH64X9	64"	69 1/2"
WCH65X9	65"	70 1/2"
WCH66X9	66"	71 1/2"
WCH67X9	67"	72 1/2"
WCH68X9	68"	73 1/2"
WCH69X9	69"	74 1/2"
WCH70X9	70"	75 1/2"
WCH72X9	72"	77 1/2"
WCH73X9	73"	78 1/2"
WCH74X9	74"	79 1/2"
WCH75X9	75"	80 1/2"
WCH76X9	76"	81 1/2"
WCH77X9	77"	82 1/2"
WCH78X9	78"	83 1/2"
WCH80X9	80"	85 1/2"
WCH81X9	81"	86 1/2"
WCH82X9	82"	87 1/2"
WCH84X9	84"	89 1/2"
WCH85X9	85"	90 1/2"
WCH86X9	86"	91 1/2"
WCH88X9	88"	93 1/2"
WCH90X9	90"	95 1/2"



## 9" Classic Crosshead

Part Number	Width	Overall Width
WCH93X9	93"	98 1/2"
WCH96X9	96"	101 1/2"
WCH99X9	99"	104 1/2"
WCH100X9	100"	105 1/2"
WCH101X9	101"	106 1/2"
WCH103X9	103"	108 1/2"
WCH104X9	104"	109 1/2"
WCH108X9	108"	113 1/2"
WCH110X9	110"	115 1/2"
WCH112X9	112"	117 1/2"

Part Number	Width	Overall Width
WCH113X9	113"	118 1/2"
WCH120X9	120"	125 1/2"
WCH124X9	124"	129 1/2"
WCH144X9	144"	149 1/2"
WCH192X9	192"	197 1/2"
WCH196X9	196"	201 1/2"
WCH197X9	197"	202 1/2"
WCH200X9	200"	205 1/2"
WCH204X9	204"	209 1/2"
WCH207X9	207"	212 1/2"

Parts may be required to ship LTL (less than truckload) based on size and overall dimensions.



Part Number Logic:

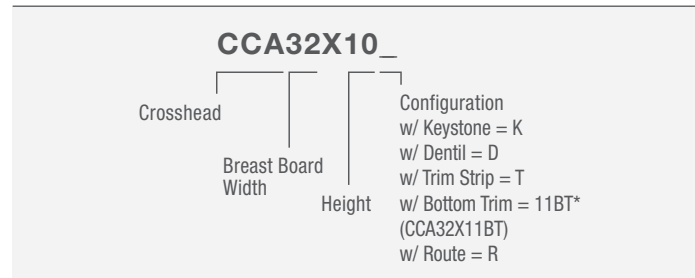

### 10" Classic Crosshead

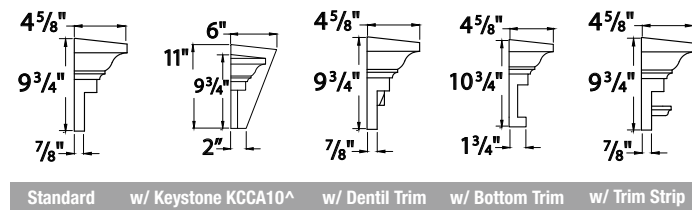
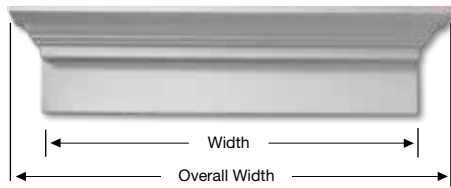

\* Bottom trim adds 1" to overall height.

Part Number	Width	Overall Width
CCA32X10	32"	37 1/4"
CCA34X10	34"	39 1/4"
CCA36X10	36"	41 1/4"
CCA40X10	40"	45 1/4"
CCA47X10	47"	52 1/4"
CCA52X10	52"	57 1/4"
CCA64X10	64"	69 1/4"
CCA72X10	72"	77 1/4"
CCA100X10	100"	105 1/4"
CCA106X10	106"	111 1/4"
CCA199X10	199"	204 1/4"
CCA200X10	200"	205 1/4"

^ This part uses Keystone KCCA10 only.



Part Number Logic:

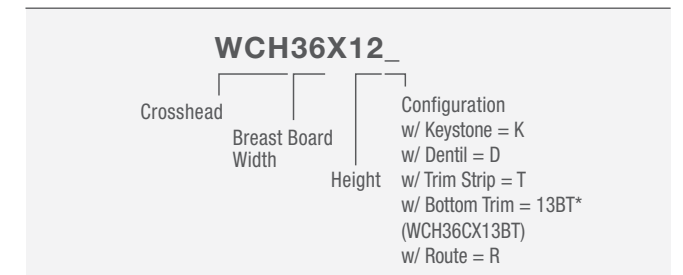

### 12" Classic Crosshead

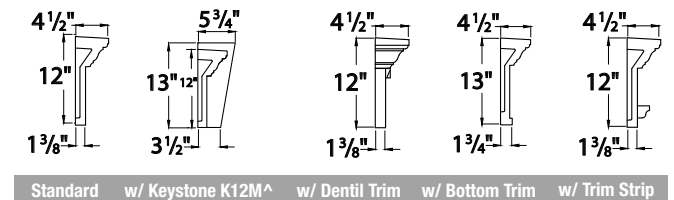
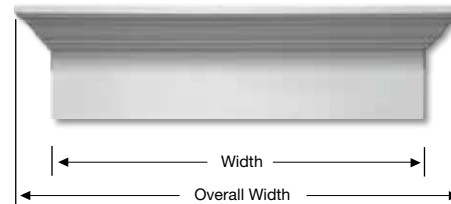

\* Bottom trim adds 1" to overall height.

Part Number	Width	Overall Width
WCH36X12	36"	41 1/2"
WCH37X12	37 5/8"	43 1/8"
WCH40X12	40"	45 1/2"
WCH44X12	44"	49 1/2"
WCH48X12	48"	53 1/2"
WCH54X12	54"	59 1/2"
WCH56X12	56"	61 1/2"
WCH64X12	64"	69 1/2"

^ This part uses Keystone K12M only.

Parts may be required to ship LTL (less than truckload) based on size and overall dimensions.

Part Number	Width	Overall Width
WCH72X12	72"	77 1/2"
WCH96X12	96"	101 1/2"
WCH102X12	102"	107 1/2"
WCH104X12	104"	109 1/2"
WCH144X12	144"	149 1/2"
WCH200X12	200"	205 1/2"
WCH203X12	203"	208 1/2"
WCH213X12	213"	218 1/2"



# 6" Crosshead Arch

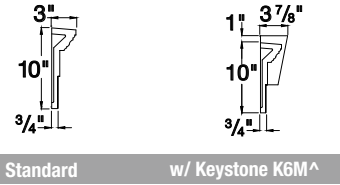
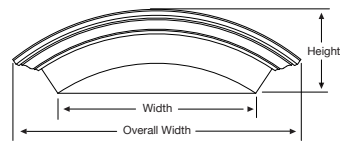

Part Number	Part Number w/ Keystone	Width	Overall Width	Height
WCH6ARS34X10	WCH6ARS34X10K	34"	42 7/8"	10"

^ This part uses Keystone K6M only. Refer to page 53 for more Keystone options.

### Part Number Logic:

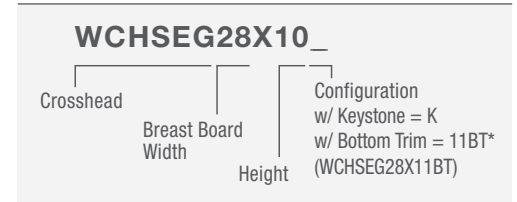

# 10" Eyebrow Crosshead

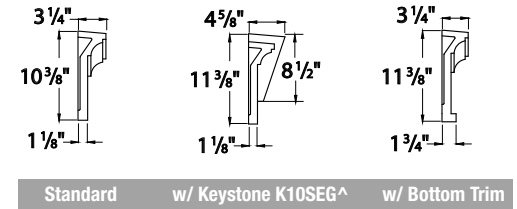
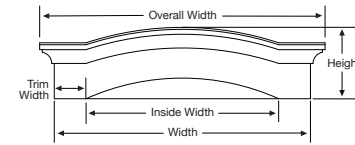

\* Bottom trim adds 1" to overall height.

Part Number	Width	Inside Width	Overall Width
WCHSEG28X10	37 1/4"	28"	41 1/2"
WCHSEG30X10	39 1/8"	29 7/8"	43 3/8"
WCHSEG34X10	44"	34"	48 1/4"
WCHSEG36X10	45"	36"	49 1/4"
WCHSEG43X10	48"	43"	52 1/4"
WCHSEG44X10	49"	44"	53 1/4"
WCHSEG64X10	73 1/4"	64"	77 1/2"
WCHSEG72X10	81"	72"	85 1/4"

^ This part uses Keystone K10SEG only.

### Part Number Logic:

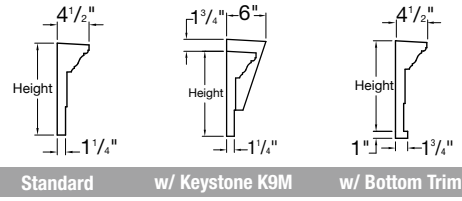
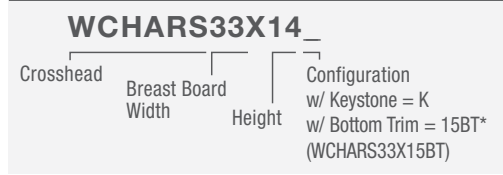

\* Bottom trim adds 1" to overall height.

# 9" Crosshead Arch

Solid

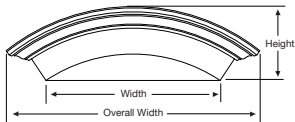

Part Number	Width	Overall Width	Height
WCHARS33X14	33"	48 1/8"	14"
WCHARS36X13	36"	49 1/4"	13"
WCHARS43X13	43"	55 1/4"	13"
WCHARS54X16	54"	68 1/8"	16"
WCHARS64X14	64"	75 1/2"	14"
WCHARS68X12	68"	77 1/4"	12"
WCHARS68X16	68"	80 7/8"	16"
WCHARS72X13	72"	82 1/8"	13"
WCHARS75X13	75"	84 7/8"	13 3/8"
WCHARS80X15	80"	91 1/4"	15"
WCHARS84X16	84"	95 3/4"	16"
WCHARS89X13	89"	98 3/8"	13"
WCHARS97X17	97"	108 3/4"	17"
WCHARS101X13	101"	110"	13"
WCHARS108X19	108"	119 7/8"	19 1/4"

# Large Door Crosshead

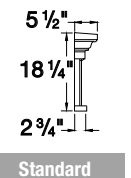
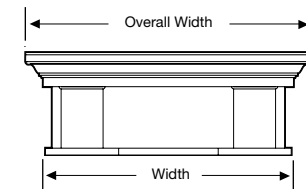

Part Number	Width	Overall Width	Pediment	Pilaster
LDCH58X18	58"	67 1/2"	AP667, PCP667, RHP667, SP667	All 11" Pilasters
LDCH62X18	62"	71 1/2"	AP667, PCP667, RHP667, SP667	
LDCH87X18	87"	96 1/2"	—	
LDCH90X18	90 1/2"	100"	RHP6100	
LDCH94X18	94 1/2"	104"	RHP6100	

Parts may be required to ship LTL (less than truckload) based on size and overall dimensions.



# Half-Round Spoked Pediment

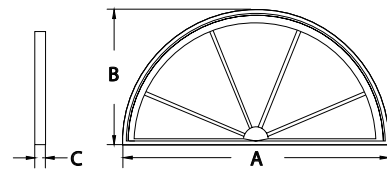

Part Number	Width (A)	Height (B)	Projection (C)	Flat Trim	Decorative Trim
HRSP36X18	36"	18"	1 3/4"	AR36X4F AR36X6F	AR36X4M, AR36X6M AR36X10MC
HRSP48X24	48"	24"	1 3/4"	AR48X4F AR48X6F	AR48X4M, AR48X6M
HRSP72X36	72"	36"	1 3/4"	AR72X4F	AR72X6M



# Half-Round Sunburst

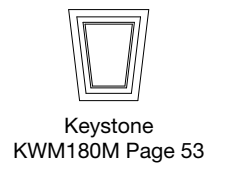
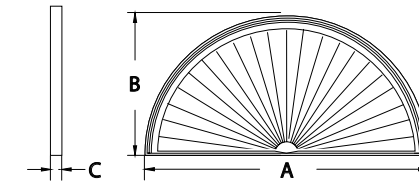

Part Number	Width (A)	Height (B)	Projection (C)	Flat Trim	Decorative Trim
SWDH24X12	24"	12"	1 3/4"	AR24X4F	—
SWDH28X14	28"	14"	1 3/4"	—	—
SWDH30X15	30"	15"	1 3/4"	—	—
SWDH32X16	32"	16"	1 3/4"	—	—
SWDH33X17	33 5/8"	16 3/4"	1 3/4"	—	—
SWDH36X18	36"	18"	1 3/4"	AR36X4F AR36X6F	AR36X4M, AR36X6M AR36X10MC
SWDH37X19	37 5/8"	18 3/4"	1 3/4"	AR37X4F	—
SWDH40X20	40"	20"	1 3/4"	—	AR40X6M DVP40
SWDH42X21	42"	21"	1 3/4"	—	—
SWDH44X22	44"	22"	1 3/4"	—	—
SWDH48X24	48"	24"	1 3/4"	AR48X4F AR48X6F	AR48X4M, AR48X6M
SWDH56X28	56"	28"	1 3/4"	—	—
SWDH60X30	60"	30"	1 3/4"	—	AR60X6M
SWDH64X32	64"	32"	1 3/4"	—	AR64X10MC
SWDH68X34	68"	34"	1 3/4"	—	—
SWDH72X36	72"	36"	1 3/4"	AR72X4F	AR72X6M
SWDH76X38	76"	38"	1 3/4"	—	—
SWDH100X50	100"	50"	1 3/4"	—	—

# Segment Sunburst

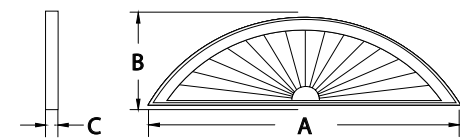

Part Number	Width (A)	Height (B)	Projection (C)
SWDH36X9	36"	9"	1 3/4"
SWDH40X10	40"	10"	1 3/4"
SWDH48X13	48"	13"	1 3/4"
SWDH68X14	67 5/8"	14"	1 3/4"
SWDH72X14	72"	14"	1 3/4"
SWDH76X15	76"	15"	1 3/4"
SWDH80X15	79 1/2"	15"	1 3/4"

# Elliptical Sunburst

with Decorative Trim

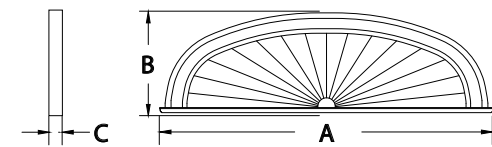

Part Number	Width (A)	Height (B)	Projection (C)
ESWDH76X23	76 7/8"	23"	3 1/2"

Parts may be required to ship LTL (less than truckload) based on size and overall dimensions.



## Half-Round Sunburst

with Flat Trim & Keystone

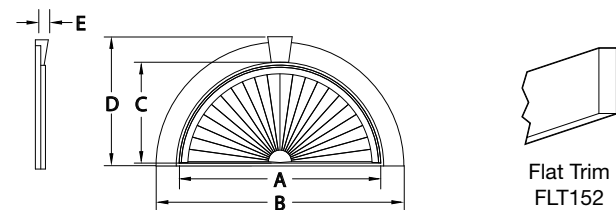

Part Number	Width (A)	Overall Width (B)	Height (C)	Overall Height (D)	Projection (E)
SWDH36X18-4FK	36"	43"	18"	22 1/2"	2 1/4"

## Sunburst Pediment

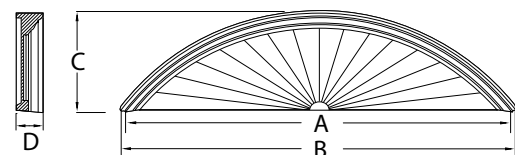

Part Number	Width (A)	Overall Width (B)	Height (C)	Projection (D)	Crosshead
SP56	55 1/4"	57"	16 3/4"	4 1/2"	WCH50X9
SP667	66 3/4"	69 1/4"	20 3/8"	5 1/2"	LDCH58X18 LDCH62X18
SP86	85 5/8"	87 1/4"	22 1/2"	4 1/2"	WCH81X9
SP91	90 1/2"	92 1/2"	26"	4 1/2"	WCH86X9

## Combination Sunburst Pediment

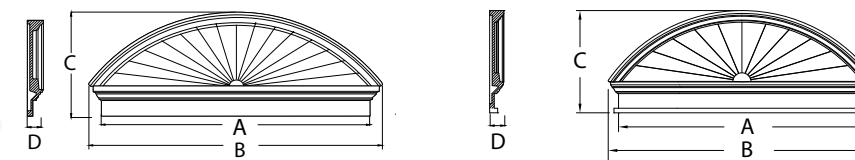

Part Number	Width (A)	Overall Width (B)	Height (C)	Projection (D)	Breast Board Thickness	Part Number w/ Bottom Trim
CSP54	54"	58 1/2"	21 3/8"	3 1/8"	1"	CSP54BT
CSP75	75"	79 5/8"	23 3/4"	3 1/8"	1"	CSP75BT
CSP80	80"	84 5/8"	25 1/2"	3 1/8"	1"	CSP80BT
CSP85	85"	89 1/2"	26 3/8"	3 1/8"	1"	CSP85BT

Note: Bottom trim adds 1" to overall height.

## Combination Segment Arch Pediment

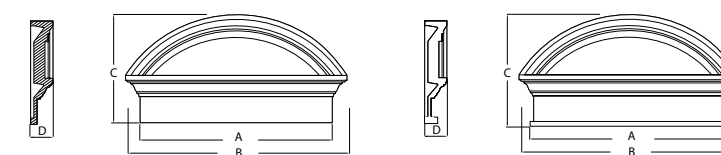

Part Number	Width (A)	Overall Width (B)	Height (C)	Projection (D)	Part Number w/ Bottom Trim
CSAP36	36"	41 1/2"	20"	4 1/2"	CSAP36BT
CSAP48	48"	53 1/2"	22 1/2"	4 1/2"	CSAP48BT
CSAP65	65"	70 1/2"	28 3/8"	4 1/2"	CSAP65BT
CSAP84	84"	89 1/2"	28"	4 1/2"	CSAP84BT

Parts may be required to ship LTL (less than truckload) based on size and overall dimensions.



## Peaked Cap Pediment



Part Number	Overall Width (A)	Overall Height (B)	Projection (C)	Pitch (D)	Crosshead
PCP56	56 1/2"	13 5/8"	4 1/2"	5 1/2 / 12	WCH50X9
PCP667	68 3/4"	23 5/8"	5 1/2"	8 / 12	LDCH58X18 LDCH62X18

## Combination Peaked Cap Pediment

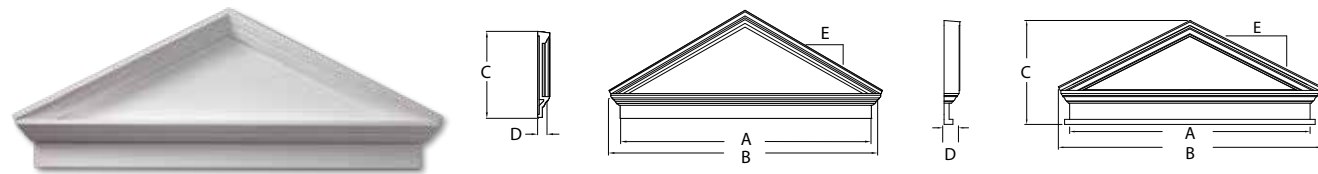

Part Number	Width (A)	Overall Width (B)	Overall Height (C)	Projection (D)	Pitch (E)	Breast Board Thickness	Part Number w/ Bottom Trim
CPCP48	47 1/2"	52"	19 1/2"	3 1/8"	6 / 12	1"	CPCP48BT
CPCP50	50"	54 1/2"	20 1/4"	3 1/8"	6 / 12	1"	CPCP50BT
CPCP54	54"	58 1/4"	21"	3 1/8"	6 / 12	1"	CPCP54BT
CPCP58	58"	62 3/8"	22"	3 1/8"	6 / 12	1"	CPCP58BT
CPCP67	67 1/2"	72"	24 1/2"	3 1/8"	6 / 12	1"	CPCP67BT
CPCP75	75"	79 1/2"	26 1/4"	3 1/8"	6 / 12	1"	CPCP75BT
CPCP80	80"	84 1/2"	27 5/8"	3 1/8"	6 / 12	1"	CPCP80BT
CPCP85	85"	89 1/2"	28 3/4"	3 1/8"	6 / 12	1"	CPCP85BT

Note: Bottom trim adds 1" to overall height.



## Combination Peaked Cap Pediment

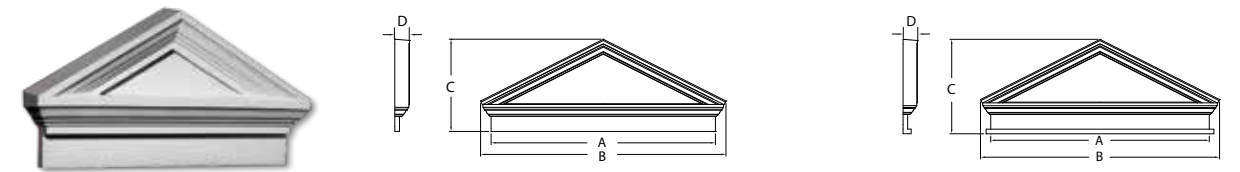

Part Number	Width (A)	Overall Width (B)	Height (C)	Projection (D)	Part Number w/ Bottom Trim
CCP37	37 5/8"	41 3/4"	20 1/2"	4 1/2"	CCP37BT

Parts may be required to ship LTL (less than truckload) based on size and overall dimensions.

## Acorn Pediment



Note: Acorn ships unattached in carton.

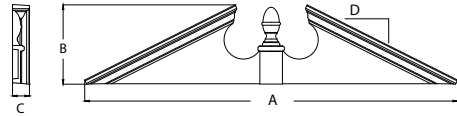

Part Number	Overall Width (A)	Overall Height (B)	Projection (C)	Pitch (D)	Crosshead
AP56	57"	16 5/8"	4 1/2"	6 1/2 / 12	WCH50X9
AP61	62"	16 3/4"	4 1/2"	7 / 12	WCH54X9 WCH56X9
AP667	68 7/8"	23 1/4"	5 1/2"	12 / 12	LDCH58X18 LDCH62X18
AP86	87 1/4"	24"	4 1/2"	7 / 12	WCH81X9
AP91	92 1/8"	24 1/2"	4 1/2"	6 / 12	WCH86X9
AP98	99 1/8"	24 1/2"	4 1/2"	6 / 12	WCH90X9 WCH93X9

## Acorn Pediment

Adjustable



Note: Ships in 4 pieces.

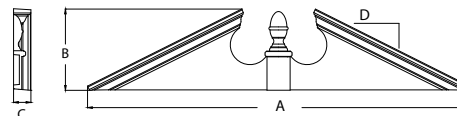

Part Number	Overall Width (A)	Overall Height (B)	Projection (C)	Pitch (D)	Crosshead
AP115	105"-115"	25 5/8"	4 1/2"	6 / 12	9" WCH from 100"-110"

## Combination Acorn Pediment



Note: Acorn ships unattached in carton.

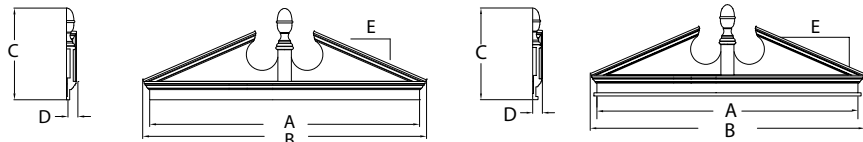

Part Number	Width (A)	Overall Width (B)	Overall Height (C)	Projection (D)	Pitch (E)	Part Number w/ Bottom Trim
CAP47E <sup>^</sup>	47"	50 1/8"	13 5/8"	2 1/8"	5 / 12	—
CAP50	50"	54 1/2"	21 1/8"	3 1/8"	6 / 12	CAP50BT
CAP54	54"	58 1/2"	21 3/8"	3 1/8"	6 / 12	CAP54BT
CAP58	58"	62 1/2"	21 3/4"	3 1/8"	6 / 12	CAP58BT
CAP67	67 1/2"	72"	24 1/8"	3"	6 / 12	CAP67BT
CAP75	75"	79 1/2"	25 1/8"	3 1/8"	6 / 12	CAP75BT
CAP80	80"	84 7/16"	25 3/8"	3 1/8"	5 1/2 / 12	CAP80BT
CAP85	85"	89 3/8"	28 3/4"	3 1/8"	5 / 12	CAP85BT

Note: Bottom trim adds 1" to overall height.

<sup>^</sup> Economy style; does not have breastboard. Accessories cannot be

## Rams Head Pediment



Note: Urn ships unattached in carton.

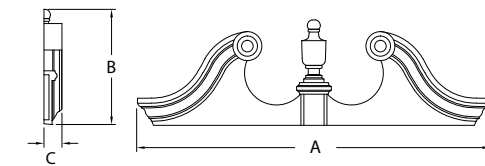

Part Number	Overall Width (A)	Overall Height (B)	Projection (C)	Crosshead
RHP56	60 7/8"	19 1/8"	4 1/2"	WCH50X9
RHP86	93 1/4"	29 1/2"	4 1/2"	WCH81X9

## Rams Head Pediment

with Decorative Trim

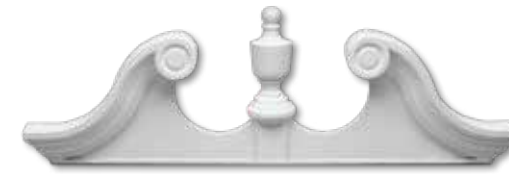

Note: Urn ships unattached in carton.

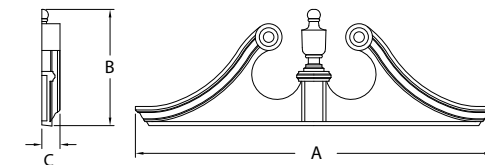

Part Number	Overall Width (A)	Overall Height (B)	Projection (C)	Crosshead
RHP667	73 1/2"	21 1/2"	5 1/2"	LDCH58X18 LDCH62X18
RHP6100	107 1/4"	29 3/8"	5 1/2"	LDCH90X18 LDCH94X18

## Combination Rams Head Pediment



Note: Urn ships unattached in carton.

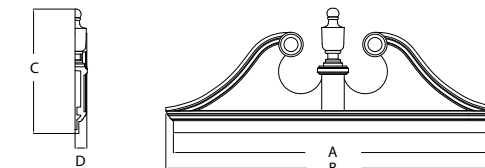

Part Number	Width (A)	Overall Width (B)	Overall Height (C)	Projection (D)	Breast Board Thickness	Part Number w/ Bottom Trim
CRHP54	54"	58"	23 1/2"	3 1/8"	1"	CRHP54BT
CRHP67	67 1/2"	71 1/2"	27"	3 1/8"	1"	CRHP67BT
CRHP75	75"	79"	29 1/8"	3 1/8"	1"	CRHP75BT
CRHP80	80"	84"	35 3/4"	3 1/8"	1"	CRHP80BT
CRHP85	85"	89"	33 5/8"	3 1/8"	1"	CRHP85BT

Note: Bottom trim adds 1" to overall height.





## Deluxe Victorian Pediment



Part Number	Inside Width (A)	Inside Height	Overall Width (B)	Radius	Pitch (C)	Accessories
DVP40	40"	24 1/2"	67 1/4"	20"	7 / 12	PIL8X90P, PIL8X108P, SWDH40X20

## 7" Panel Arch

with Sunburst & Keystone

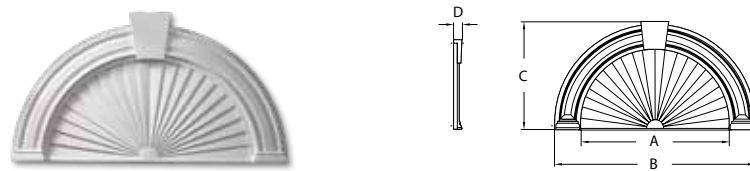

Part Number	Sunburst Width (A)	Overall Width (B)	Height (C)	Radius	Keystone Projection (D)	Pilaster
AR40X54PSK	40"	54"	29"	20"	2 5/8"	PIL7X90DP^

^ PIL7X90DP matches this arch profile only.

## 10" Decorative Arch

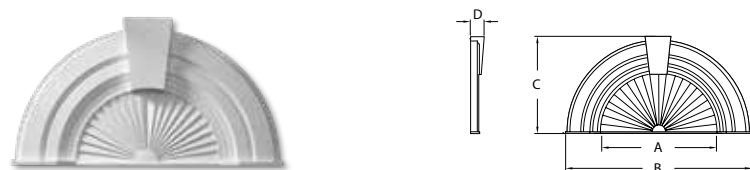

Part Number	Sunburst Width (A)	Overall Width (B)	Height (C)	Radius	Keystone Projection (D)	Pilaster
AR36X10SK	36"	56"	30 1/8"	2 1/8"	4"	PIL10X96A^, PIL10X192A^

^ This arch matches PIL10X96A and PIL10X192A only.

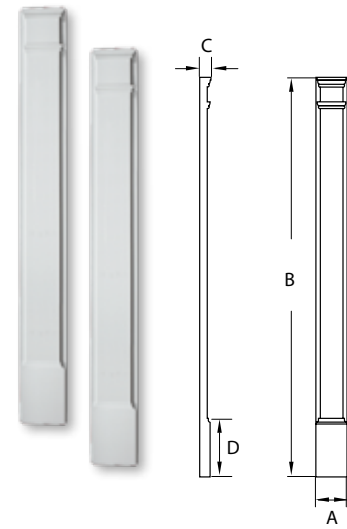

## Plain Pilaster

Moulded with Plinth

Part Number	Width (A)	Height (B)	Projection (C)	Plinth Block Height (D)
PIL5X90P	5 1/4"	90"	1 5/8"	10 1/8"
PIL6X90P	6"	90"	2 1/2"	13 1/4"
PIL7X90P	7"	90"	2 1/2"	13 1/4"
PIL8X90P	8"	90"	2 1/2"	13 1/4"
PIL9X90P	9"	90"	3"	14 1/2"
PIL11X90P	11"	90"	3 1/2"	13 1/4"

Note: Sold in pairs. Pilaster may be routed for J-Channel.

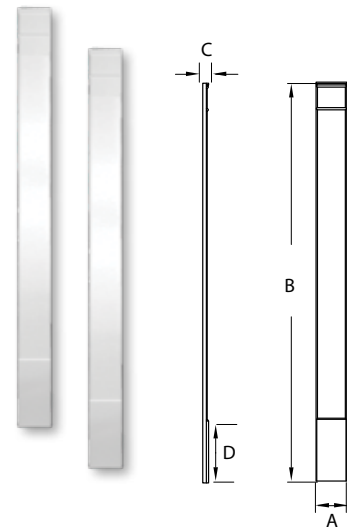

## Plain Economy Pilaster

Moulded with Plinth

Part Number	Width (A)	Height (B)	Projection (C)	Plinth Block Height (D)
PIL7X90PE	7"	90"	1 1/4"	14 1/4"

Note: Sold in pairs. Pilaster may be routed for J-Channel.



Parts may be required to ship LTL (less than truckload) based on size and overall dimensions.

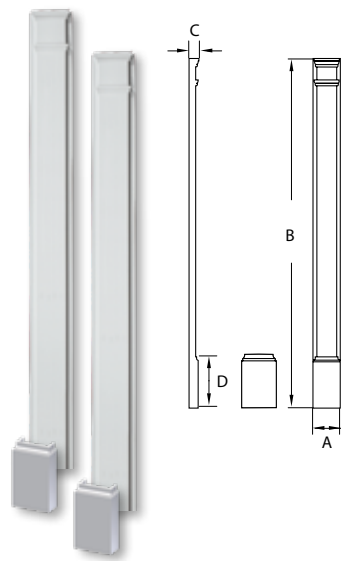

## Plain Pilaster

Two-Piece Adjustable

Part Number	Width (A)	Height (B)	Projection (C)	Plinth Block Height (D)
PIL5X108P	5 1/4"	108"	1 5/8"	10"
PIL6X120P	6"	120"	2 1/2"	13 1/4"
PIL7X108P	7"	108"	2 1/2"	13"
PIL7X120P	7"	120"	2 1/2"	13"
PIL8X108P	8"	108"	2 5/8"	13"
PIL9X108P	9"	108"	3"	14 1/2"
PIL9X120P	9"	120"	3"	14 1/2"
PIL10X120P	10"	120"	3 1/4"	14 1/2"
PIL11X96P	11"	96"	3 1/2"	14 1/2"
PIL11X108P	11"	108"	3 1/2"	14 1/2"
PIL11X109P	11"	109"	3 1/2"	14 1/2"
PIL11X120P	11"	120"	3 1/2"	14 1/2"

Note: Sold in pairs. Pilaster may be routed for J-Channel.

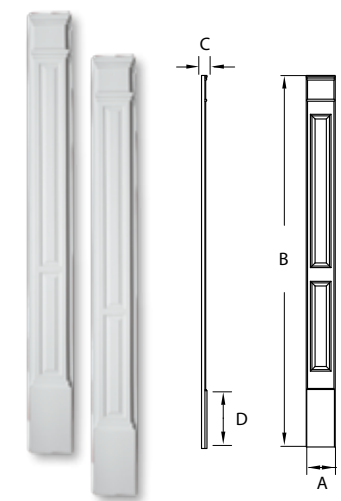

## Double Panel Pilaster

Moulded with Plinth

Part Number	Width (A)	Height (B)	Projection (C)	Plinth Block Height (D)
PIL5X90DP	5 1/4"	90"	1 5/8"	10 1/8"
PIL7X90DP	7"	90"	2 1/2"	13 1/4"
PIL9X90DP	9"	90"	3"	14 1/2"
PIL9X100DP	9"	100"	3"	14 1/2"
PIL11X90DP	11"	90"	3 1/2"	14 1/2"
PIL11X108DP	11"	108"	3 1/2"	14 1/2"

Note: Sold in pairs. Pilaster may be routed for J-Channel.

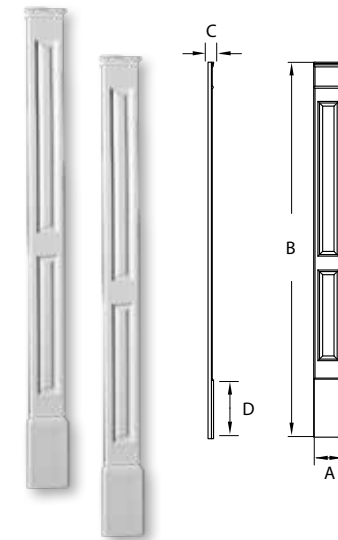

## Double Panel Economy Pilaster

Moulded with Plinth

Part Number	Width (A)	Height (B)	Projection (C)	Plinth Block Height (D)
PIL7X90DPE	7"	90"	1 1/4"	14 1/4"

Note: Sold in pairs. Pilaster may be routed for J-Channel.

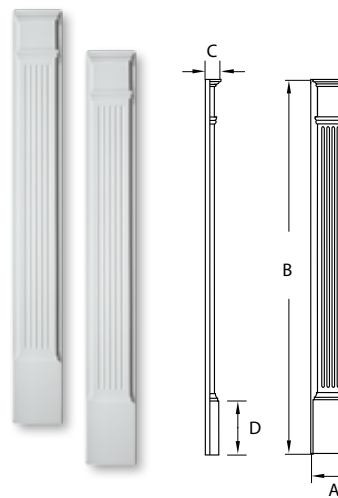

## Fluted Pilaster

Moulded with Plinth

Part Number	Width (A)	Height (B)	Projection (C)	Plinth Block Height (D)
PIL3X81	3 1/2"	81"	1 5/8"	10"
PIL4X83	4 1/2"	82 3/4"	1 5/8"	7 3/4"
PIL4X86	4 1/2"	86"	1 5/8"	11"
PIL4X90	4 1/2"	90"	1 5/8"	10"
PIL5X82	5 1/4"	82"	1 3/4"	8"
PIL5X90	5 1/4"	90"	1 3/4"	10 1/8"
PIL6X90	6 1/4"	90"	2 1/2"	13 1/4"
PIL7X90	7"	90"	2 1/2"	13 1/4"
PIL9X90	9"	90"	3"	14 1/2"
PIL11X90	11"	90"	3 1/2"	14 1/2"

Note: Sold in pairs. Pilaster may be routed for J-Channel.  
Parts may be required to ship LTL (less than truckload) based on size and overall dimensions.



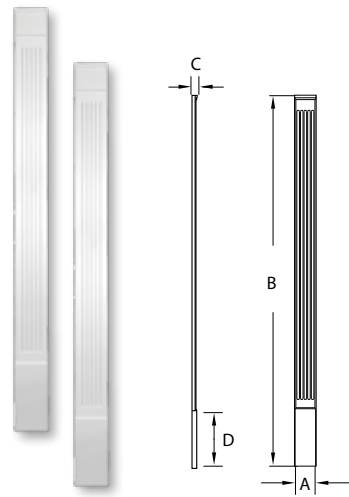

## Fluted Economy Pilaster

Moulded with Plinth

Part Number	Width (A)	Height (B)	Projection (C)	Plinth Block Height (D)
PIL3X90E	3"	90"	1 1/4"	14 1/4"
PIL5X90E	5 1/4"	90"	1 1/4"	14 1/4"
PIL7X90E	7"	90"	1 1/4"	14 1/4"
PIL9X90E	9"	90"	1 1/4"	14 1/4"

Note: Sold in pairs.  
Pilaster may be routed for J-Channel.

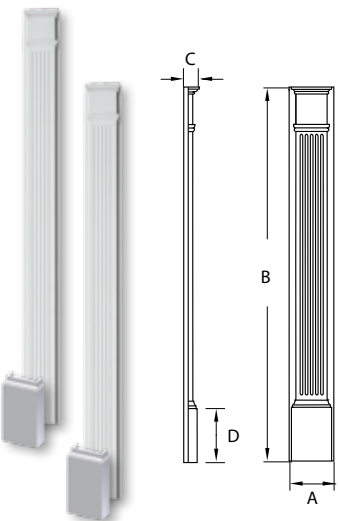

## Fluted Pilaster

Two-Piece Adjustable

Part Number	Width (A)	Height (B)	Projection (C)	Plinth Block Height (D)
PIL3X108	3 1/2"	108"	1 5/8"	10"
PIL4X108	4 1/2"	108"	1 5/8"	10"
PIL5X108	5 1/4"	108"	1 5/8"	10"
PIL6X108	6 1/4"	108"	2 1/2"	13 1/4"
PIL6X144	6 1/4"	144"	2 1/2"	13 1/4"
PIL7X102	7"	102"	2 1/2"	13 1/4"
PIL7X108	7"	108"	2 1/2"	13"
PIL7X144	7"	144"	2 1/2"	13"
PIL8X90	8"	90"	2 1/2"	13"
PIL8X108	8"	108"	2 1/2"	13"
PIL8X144	8"	144"	2 1/2"	13"
PIL9X102	9"	102"	3"	14 1/2"
PIL9X108	9"	108"	3"	14 1/2"
PIL9X144	9"	144"	3"	14 1/2"
PIL11X108	11"	108"	3 1/2"	14 1/2"
PIL11X120	11"	120"	3 1/2"	14 1/2"
PIL11X144	11"	144"	3 1/2"	14 1/2"

Note: Sold in pairs.

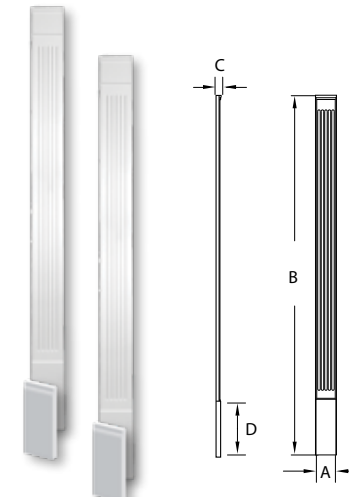

## Fluted Economy Pilaster

Two-Piece Adjustable

Part Number	Width (A)	Height (B)	Projection (C)	Plinth Block Height (D)
PIL5X120E	5 1/4"	120"	1 1/4"	14 1/4"
PIL7X120E	7"	120"	1 1/4"	14 1/4"

Note: Sold in pairs.  
Pilaster may be routed for J-Channel.

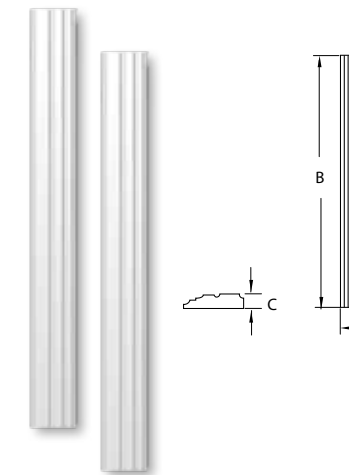

## Arch Profile Pilaster

Matches 10M Decorative Arches

Part Number	Width (A)	Height (B)	Projection (C)
PIL10X96A	10"	96"	2 3/8"
PIL10X192A	10"	192"	2 3/8"

Note: Sold in pairs. See page 42 and 50 for matching arches.

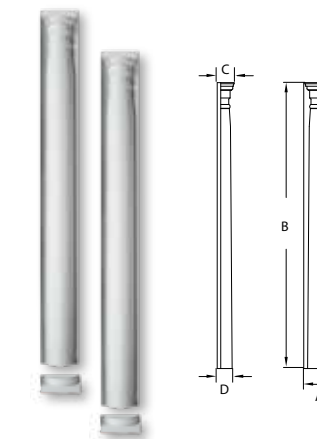

## Half-Round Pilaster

Adjustable Column

Part Number	Width (A)	Shaft Height (B)	Top Projection (C)	Bottom Projection (D)
PIL10X96HC	10"	93 5/8"	4 7/8"	5 1/2"

Note: Sold in pairs.

^ Overall height is adjustable from 80"-96". Shaft sits on top of plinth, which is 3" in height.  
Parts may be required to ship LTL (less than truckload) based on size and overall dimensions.

## Fluted Panel Trim

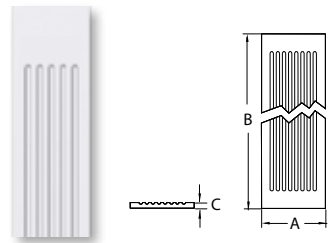

Part Number	Width (A)	Height (B)	Projection (C)
FP9X168 <sup>^</sup>	8 1/2"	168"	1 1/4"
FP12X96	12"	96"	1 1/2"

<sup>^</sup> Actual product has flutes running the full length on this size only.



## Half-Round Arch Trim

4F Flat

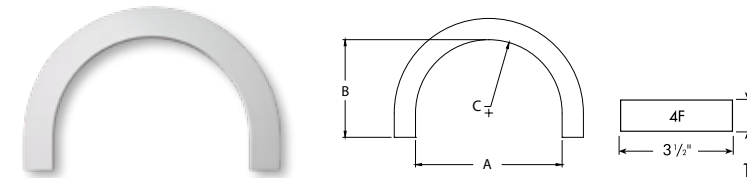

Accessories

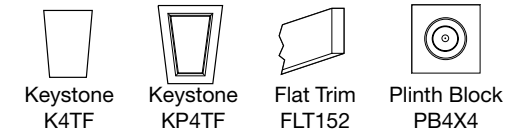

Part Number	Inside Width (A)	Inside Height (B)	Radius (C)
AR24X4F	24 1/8"	16 1/8"	12 1/8"
AR36X4F	36"	22"	18"
AR37X4F	37 5/8"	22 3/4"	18 3/4"
AR48X4F	48"	28"	24"
AR72X4F	72"	40"	36"

Note: This part uses Keystones K4TF and KP4TF only.

## Half-Round Arch Trim

4M Decorative

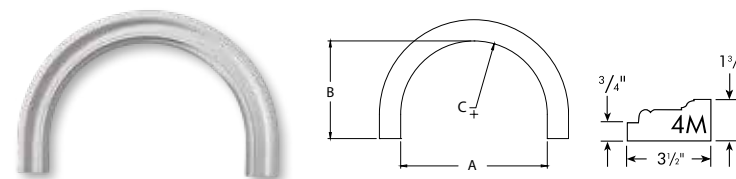

Accessories



Part Number	Inside Width (A)	Inside Height (B)	Radius (C)
AR36X4M	36"	22"	18"
AR48X4M	48"	28"	24"

Note: This part uses Keystones K4TM and KP4TM only.

Parts may be required to ship LTL (less than truckload) based on size and overall dimensions.



## Half-Round Arch Trim

6F Flat

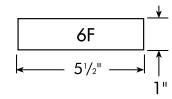
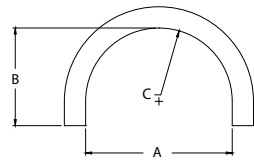

### Accessories

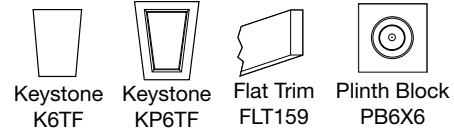

Part Number	Inside Width (A)	Inside Height (B)	Radius (C)
AR36X6F	36"	22"	18"
AR48X6F	48"	28"	24"

Note: This part uses Keystones K6TF and KP6TF only.

## Half-Round Arch Trim

6M Decorative

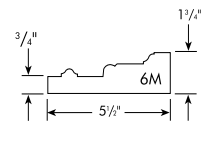
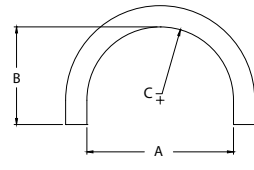

### Accessories



Part Number	Inside Width (A)	Inside Height (B)	Radius (C)
AR36X6M	36"	21"	18 1/8"
AR40X6M	40"	24"	20"
AR48X6M	48"	28"	24"
AR60X6M	60"	34"	30"
AR72X6M	72"	40"	36"

Note: This part uses Keystones K6TM and KP6TM only.

Parts may be required to ship LTL (less than truckload) based on size and overall dimensions.

## Half-Round Arch Trim

10M Decorative

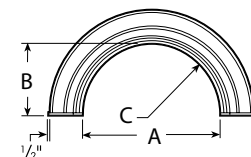
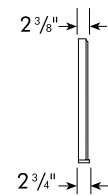

### Accessories

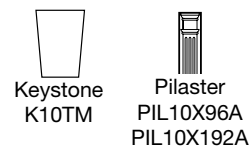

Part Number	Inside Width (A)	Inside Height (B)	Radius (C)
AR36X10MC	36"	18 3/4"	18"
AR64X10MC	64"	32 3/4"	32"

## Half-Round Arch with Flankers

10M Decorative

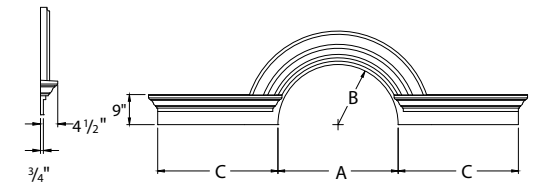

Part Number	Inside Width (A)	Inside Height / Radius (B)	Flanker Width (C)	Overall Width (D)	Accessories
AR36X10MFL108	36"	18"	36"	108"	K10TM SWDH36X18

Parts may be required to ship LTL (less than truckload) based on size and overall dimensions.

## Circle Trim

4F Flat

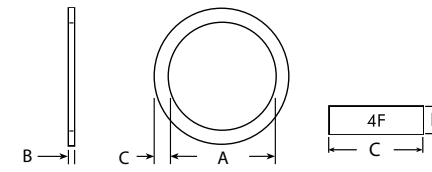
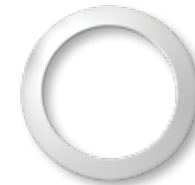

Part Number	Inside Width (A)	Projection (B)	Trim Width (C)
CIR24X4F	24 1/4"	1"	3 1/2"
CIR36X4F	36 1/8"	1"	3 1/2"

## Oval Trim

4F Flat

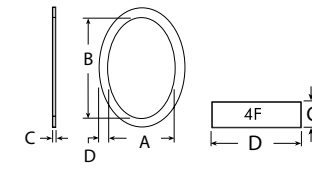

Part Number	Inside Width (A)	Inside Height (B)	Projection (C)	Trim Width (D)
OV24X36X4F	24 1/8"	36 1/8"	1"	3 1/2"

## Oval Trim

4M Decorative

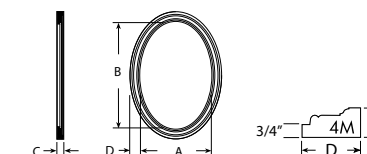

Part Number	Inside Width (A)	Inside Height (B)	Projection (C)	Trim Width (D)
OV24X36X4M	24 1/8"	36 1/8"	1 3/4"	3 1/2"

# Window Panel

Flat Panel

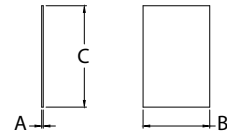

Part Number	Thickness (A)	Width (B)	Height (C)
FLT40X96*	1"	40"	96"
WDP48X73F	1 1/8"	48"	73"

\*Can also be found on page 82 under Flat Trim.

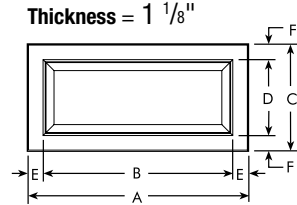

# Window Panel

Raised Panel



Part Number	Overall Width (A)	Panel Width (B)	Overall Height (C)	Panel Height (D)	Border Width (E)	Border Height (F)
WDP36X18	36"	28"	18"	10"	4"	4"

# Dormer Trim System

Part Number	Width (A)	Overall Width (B)	Overall Height (C)	Projection (D)	Pitch (E)
 <b>DMP44</b> Pediment	43 3/4"	49 1/4"	33 1/4"	4 1/2"	14 / 12
 <b>DMST7X69</b> Side Trim Set	6 3/4"	—	68 5/8"	1 1/2"	—
 <b>DMR457-10</b> Return	—	—	—	—	—

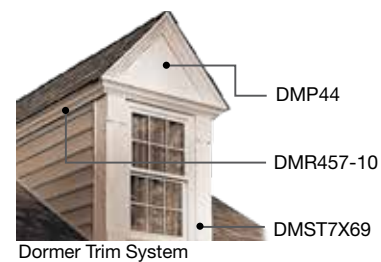

Dormer Trim System

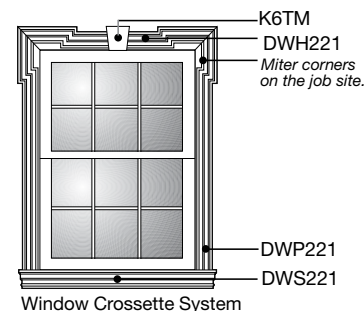















Window Crossette System

**MLD221**  
MLD221 can be used as a header in place of DWH221 to avoid a center seam.

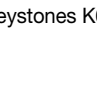

# Keystones

for Trim Profiles

Part Number	Top Width (A)	Bottom Width (B)	Height (C)	Top Projection (D)	Bottom Projection (E)	Arches & Trim
 <b>K6*</b>	4 3/4"	2 3/4"	6 1/2"	2 1/4"	1 5/8"	—
 <b>K8*</b>	9 3/4"	5 3/4"	7 3/4"	2 1/4"	1 1/4"	—
 <b>K6M</b>	5 3/4"	4"	7"	3 7/8"	1 1/2"	6" WCH, 6" WCH w/ BT 6" CH, 6" CH w/ BT
 <b>K9M</b>	8"	6"	11"	6 1/8"	1 1/8"	9" WCH, 9" WCH w/ BT 9" CH, 9" CH w/ BT
 <b>K12M</b>	8 1/2"	6"	13"	5 3/4"	2 1/8"	12" WCH
 <b>K10SEG</b>	8"	6"	8 1/2"	4 5/8"	3/4"	10" WCHSEG
 <b>KCCA10</b>	8"	6"	11"	6"	1 1/8"	10" CCA
 <b>KP6M</b>	5 3/4"	4"	7"	4 1/8"	1 3/4"	6" WCH, 6" WCH w/ BT 6" CH, 6" CH w/ BT
 <b>KP9M</b>	8"	6"	11"	6 1/4"	1 5/8"	9" WCH, 9" WCH w/ BT 9" CH, 9" CH w/ BT
 <b>K4TF</b>	4 1/4"	3"	4 1/2"	2 1/4"	1/2"	4F Arches FLT152
 <b>K6TF</b>	6"	4"	7"	2 3/8"	5/8"	6F Arches FLT159
 <b>K8TF</b>	7"	5"	8 7/8"	2 1/2"	3/4"	FLT162
 <b>K4TM</b>	4 1/4"	3"	4 1/2"	2 1/4"	3/4"	4M Arches MLD215
 <b>K6TM</b>	6"	4"	7"	2 3/8"	7/8"	6M Arches MLD220 DWH221
<b>K10TM</b>	8"	5 1/2"	11 1/2"	4"	1 3/4"	10M Arch Trim PIL10X96A PIL10X192A
<b>KP4TF</b>	4 1/4"	3"	4 1/2"	2 1/4"	1/2"	4F Arches FLT152
<b>KP6TF</b>	6"	4"	7"	2 3/8"	5/8"	6F Arches FLT159
<b>KP4TM</b>	4 1/4"	3"	4 1/2"	2 3/4"	3/4"	4M Arch Trim MLD215
<b>KP6TM</b>	6"	4"	7"	2 1/2"	7/8"	6M Arch Trim MLD220 DWH221
<b>KWM180M</b>	2 3/4"	2"	3 1/8"	2 1/2"	—	Brick Mould Louvers / Trim MLDWM180

Note: Moulded on back side to fit decorative and flat trim profiles.

\*Keystones K6 and K8 are not moulded on back side.



## Plain Door Surround Kits



Door is not included in kit.

### Part Number Logic:



Single Door   With Keystone										
Door Style	Part Number	Sidelite Width	Pilaster	Pilaster Width	Crosshead	Crosshead Width	Keystone	Door Unit Width Dimension Range (A)	Outside Dimension of DSK (B)	Crosshead Can be Trimmed
	DSKCR3068	—	—	5 1/4"	—	50"	—	Up to 36"	50"	NO
	DSKS05P516K	—	PIL5X108P	5"	WCH51X6	51"	K6M	Up to 41 1/2"	51"	YES
	DSKS07P569K	—	PIL7X108P	7"	WCH56X9	56"	K9M	Up to 42"	56"	YES
	DSKS07P5612K	—	PIL7X108P	7"	WCH56X12	56"	K12M	Up to 42"	56"	YES
	DSKS08P589K	—	PIL8X108P	8"	WCH58X9	58"	K9M	Up to 42"	58"	YES
	DSKS08P6412K	—	PIL8X108P	8"	WCH64X12	64"	K12M	Up to 48"	64"	YES
	Single Door   Without Keystone									
	DSKS05P516	—	PIL5X108P	5"	WCH51X6	51"	—	37 1/2" - 40 1/2"	51"	NO
	DSKS07P569	—	PIL7X108P	7"	WCH56X9	56"	—	40" - 42"	56"	NO
	DSKS07P5612	—	PIL7X108P	7"	WCH56X12	56"	—	40" - 42"	56"	NO
	DSKS08P589	—	PIL8X108P	8"	WCH58X9	58"	—	40" - 42"	58"	NO
	DSKS08P6412	—	PIL8X108P	8"	WCH64X12	64"	—	46" - 48"	64"	NO

Single Door   1 Sidelite   With Keystone											
Door Style	Part Number	Sidelite Width	Pilaster	Pilaster Width	Crosshead	Crosshead Width	Keystone	Door Unit Width Dimension Range (A)	Outside Dimension of DSK (B)	Crosshead Can be Trimmed	
	DSKS105P646K	10"	PIL5X108P	5"	WCH64X6	64"	K6M	Up to 53 1/2"	64"	YES	
	DSKS107P679K	10"	PIL7X108P	7"	WCH67X9	67"	K9M	Up to 53"	67"	YES	
	DSKS108P699K	10"	PIL8X108P	8"	WCH69X9	69"	K9M	Up to 53"	69"	YES	
	DSKS105P646K	12"	PIL5X108P	5"	WCH64X6	64"	K6M	Up to 53 1/2"	64"	YES	
	DSKS107P689K	12"	PIL7X108P	7"	WCH68X9	68"	K9M	Up to 54"	68"	YES	
	DSKS108P709K	12"	PIL8X108P	8"	WCH70X9	70"	K9M	Up to 54"	70"	YES	
	DSKS105P666K	14"	PIL5X108P	5"	WCH66X6	66"	K6M	Up to 55 1/2"	66"	YES	
	DSKS15P676K	10"	PIL5X108P	5"	WCH67X6	67"	K6M	Up to 56 1/2"	67"	YES	
	DSKS17P709K	14"	PIL7X108P	7"	WCH70X9	70"	K9M	Up to 56"	70"	YES	
	DSKS17P7212K	12"	PIL7X108P	7"	WCH72X12	72"	K12M	Up to 58"	72"	YES	
	DSKS18P729K	14"	PIL8X108P	8"	WCH72X9	72"	K9M	Up to 56"	72"	YES	
	DSKS18P7212K	14"	PIL8X108P	8"	WCH72X12	72"	K12M	Up to 56"	72"	YES	
	Single Door   1 Sidelite   Without Keystone										
		DSKS107P679	10"	PIL7X108P	7"	WCH67X9	67"	—	51" - 53"	67"	NO
		DSKS108P699	10"	PIL8X108P	8"	WCH69X9	69"	—	51" - 53"	69"	NO
	DSKS105P646	12"	PIL5X108P	5"	WCH64X6	64"	—	51 1/2" - 53 1/2"	64"	NO	
	DSKS107P689	12"	PIL7X108P	7"	WCH68X9	68"	—	52" - 54"	68"	NO	
	DSKS108P709	12"	PIL8X108P	8"	WCH70X9	70"	—	52" - 54"	70"	NO	
	DSKS105P666	14"	PIL5X108P	5"	WCH66X6	66"	—	53 1/2" - 55 1/2"	66"	NO	
	DSKS15P676	10"	PIL5X108P	5"	WCH67X6	67"	—	54 1/2" - 56 1/2"	67"	NO	
	DSKS17P709	14"	PIL7X108P	7"	WCH70X9	70"	—	54" - 56"	70"	NO	
	DSKS17P7212	12"	PIL7X108P	7"	WCH72X9	72"	—	54" - 56"	72"	NO	
	DSKS18P729	14"	PIL8X108P	8"	WCH72X9	72"	—	54" - 56"	72"	NO	
	DSKS18P7212	14"	PIL8X108P	8"	WCH72X12	72"	—	54" - 56"	72"	NO	

### Single Door | 2 Sidelites | With Keystone

Door Style	Part Number	Sidelite Width	Pilaster	Pilaster Width	Crosshead	Crosshead Width	Keystone	Door Unit Width Dimension Range (A)	Outside Dimension of DSK (B)	Crosshead Can be Trimmed
	DSKS205P746K	10"	PIL5X108P	5"	WCH74X6	74"	K6M	Up to 63 1/2"	74"	YES
	DSKS207P779K	10"	PIL7X108P	7"	WCH77X9	77"	K9M	Up to 63"	77"	YES
	DSKS208P809K	10"	PIL8X108P	8"	WCH80X9	80"	K9M	Up to 64"	80"	YES
	DSKS205P786K	12"	PIL5X108P	5"	WCH78X6	78"	K6M	Up to 67 1/2"	78"	YES
	DSKS207P819K	12"	PIL7X108P	7"	WCH81X9	81"	K9M	Up to 67"	81"	YES
	DSKS208P849K	12"	PIL8X108P	8"	WCH84X9	84"	K9M	Up to 68"	84"	YES
	DSKS25P846K	14"	PIL5X108P	5"	WCH84X6	84"	K6M	Up to 73 1/2"	84"	YES
	DSKS27P869K	14"	PIL7X108P	7"	WCH86X9	86"	K9M	Up to 72"	86"	YES
	DSKS27P9612K	12"	PIL7X108P	7"	WCH96X12	96"	K12M	Up to 82"	96"	YES
	DSKS28P889K	14"	PIL8X108P	8"	WCH88X9	88"	K9M	Up to 72"	88"	YES
	DSKS28P9612K	14"	PIL8X108P	8"	WCH96X12	96"	K12M	Up to 80"	96"	YES

### Single Door | 2 Sidelites | Without Keystone

	DSKS205P746	10"	PIL5X108P	5"	WCH74X6	74"	—	61 1/2" - 63 1/2"	74"	NO
	DSKS207P779	10"	PIL7X108P	7"	WCH77X9	77"	—	61" - 63"	77"	NO
	DSKS208P809	10"	PIL8X108P	8"	WCH80X9	80"	—	62" - 64"	80"	NO
	DSKS205P786	12"	PIL5X108P	5"	WCH78X6	78"	—	65 1/2" - 67 1/2"	78"	NO
	DSKS207P819	12"	PIL7X108P	7"	WCH81X9	81"	—	65" - 67"	81"	NO
	DSKS208P849	12"	PIL8X108P	8"	WCH84X9	84"	—	66" - 68"	84"	NO
	DSKS25P846	14"	PIL8X108P	8"	WCH84X9	84"	—	71 1/2" - 73 1/2"	84"	NO
	DSKS27P869	10"	PIL5X108P	5"	WCH84X6	84"	—	70" - 72"	84"	NO
	DSKS27P9612	12"	PIL7X108P	7"	WCH96X12	96"	—	80" - 82"	96"	NO
	DSKS28P889	14"	PIL8X108P	8"	WCH88X9	88"	—	70" - 72"	88"	NO
	DSKS28P9612	14"	PIL8X108P	8"	WCH96X12	96"	—	78" - 80"	96"	NO

### Double Door | With Keystone

Door Style	Part Number	Sidelite Width	Pilaster	Pilaster Width	Crosshead	Crosshead Width	Keystone	Door Unit Width Dimension Range (A)	Outside Dimension of DSK (B)	Crosshead Can be Trimmed
	DSKD05P966K	—	PIL5X108P	5"	WCH96X6	96"	K6M	Up to 85 1/2"	96"	YES
	DSKD07P939K	—	PIL7X108P	7"	WCH93X9	93"	K9M	Up to 79"	93"	YES
	DSKD07P9612K	—	PIL7X108P	7"	WCH96X12	96"	K12M	Up to 80"	99"	YES
	DSKD08P969K	—	PIL8X108P	8"	WCH96X9	96"	K9M	Up to 80"	96"	YES
	DSKD08P9612K	—	PIL8X108P	8"	WCH96X12	96"	K12M	Up to 80"	96"	YES

### Double Door | Without Keystone

	DSKD05P966	—	PIL5X108P	5"	WCH96X6	96"	—	83 1/2" - 85 1/2"	96"	NO
	DSKD07P939	—	PIL7X108P	7"	WCH93X9	93"	—	77" - 79"	93"	NO
	DSKD07P9612	—	PIL7X108P	7"	WCH96X12	96"	—	80" - 82"	96"	NO
	DSKD08P969	—	PIL8X108P	8"	WCH96X9	96"	—	78" - 80"	96"	NO
	DSKD08P9612	—	PIL8X108P	8"	WCH96X12	96"	—	78" - 80"	96"	NO

Parts may be required to ship LTL (less than truckload) based on size and overall dimensions.

## Fluted Door Surround Kits



Door is not included in kit.

### Part Number Logic:



Single Door   With Keystone										
Door Style	Part Number	Sidelite Width	Pilaster	Pilaster Width	Crosshead	Crosshead Width	Keystone	Door Unit Width Dimension Range (A)	Outside Dimension of DSK (B)	Crosshead Can be Trimmed
	DSKS05F516K	—	PIL5X108	5"	WCH51X6	51"	K6M	Up to 40 1/2"	51"	YES
	DSKCOL3068	—	PIL6X85	6"	WCH53X9K	53"	—	41"	53"	NO
	20020	—	PIL7X90	7"	WCH54X9	54"	K9M	Up to 40"	54"	YES
	DSKS07F569K	—	PIL7X108	7"	WCH56X9	56"	K9M	Up to 42"	56"	YES
	DSKS07F5612K	—	PIL7X108	7"	WCH56X12	56"	K12M	Up to 42"	56"	YES
	DSKS08F589K	—	PIL8X108	8"	WCH58X9	58"	K9M	Up to 42"	58"	YES
	DSKS08F6412K	—	PIL8X108	8"	WCH64X12	64"	K12M	Up to 48"	64"	YES
	Single Door   Without Keystone									
	DSKS05F516	—	PIL5X108	5"	WCH51X6	51"	—	37 1/2" - 40 1/2"	51"	NO
	DSKEMP3068	—	PIL7X90DP	7"	WCHARS54X16	54"	—	40"	54"	NO
	DSKS07F569	—	PIL7X108	7"	WCH56X9	56"	—	40" - 42"	56"	NO
	DSKS07F5612	—	PIL7X108	7"	WCH56X12	56"	—	40" - 42"	56"	NO
	DSKS08F589	—	PIL8X108	8"	WCH58X9	58"	—	40" - 42"	58"	NO
	DSKS08F6412	—	PIL8X108	8"	WCH64X12	64"	—	46" - 48"	64"	NO

Single Door   1 Sidelite   With Keystone											
Door Style	Part Number	Sidelite Width	Pilaster	Pilaster Width	Crosshead	Crosshead Width	Keystone	Door Unit Width Dimension Range (A)	Outside Dimension of DSK (B)	Crosshead Can be Trimmed	
	DSKS105F646K	10"	PIL5X108	5"	WCH64X6	64"	K6M	Up to 53 1/2"	64"	YES	
	DSKS107F679K	10"	PIL7X108	7"	WCH67X9	67"	K9M	Up to 53"	67"	YES	
	DSKS108F699K	10"	PIL8X108	8"	WCH69X9	69"	K9M	Up to 53"	69"	YES	
	DSKS105F646K	12"	PIL5X108	5"	WCH64X6	64"	K6M	Up to 53 1/2"	64"	YES	
	DSKS107F689K	12"	PIL7X108	7"	WCH68X9	68"	K9M	Up to 54"	68"	YES	
	DSKS108F709K	12"	PIL8X108	8"	WCH70X9	70"	K9M	Up to 54"	70"	YES	
	DSKS105F666K	14"	PIL5X108	5"	WCH66X6	66"	K6M	Up to 55 1/2"	66"	YES	
	DSKS15F676K	10"	PIL5X108	5"	WCH67X6	67"	K6M	Up to 56 1/2"	67"	YES	
	DSKS17F709K	14"	PIL7X108	7"	WCH70X9	70"	K9M	Up to 56"	70"	YES	
	DSKS17F7212K	12"	PIL7X108	7"	WCH72X12	72"	K12M	Up to 58"	72"	YES	
	DSKS18F729K	14"	PIL8X108	8"	WCH72X9	72"	K9M	Up to 56"	72"	YES	
	DSKS18F7212K	14"	PIL8X108	8"	WCH72X12	72"	K12M	Up to 56"	72"	YES	
	Single Door   1 Sidelite   Without Keystone										
		DSKS107F679	10"	PIL7X108	7"	WCH67X9	67"	—	51" - 53"	67"	NO
		DSKS108F699	10"	PIL8X108	8"	WCH69X9	69"	—	51" - 53"	69"	NO
		DSKS105F646	12"	PIL5X108	5"	WCH64X6	64"	—	51 1/2" - 53 1/2"	64"	NO
DSKS107F689		12"	PIL7X108	7"	WCH68X9	68"	—	52" - 54"	68"	NO	
DSKS108F709		12"	PIL8X108	8"	WCH70X9	70"	—	52" - 54"	70"	NO	
DSKS105F666		14"	PIL5X108	5"	WCH66X6	66"	—	53 1/2" - 55 1/2"	66"	NO	
DSKS15F676		10"	PIL5X108	5"	WCH67X6	67"	—	54 1/2" - 56 1/2"	67"	NO	
DSKS17F709		14"	PIL7X108	7"	WCH70X9	70"	—	54" - 56"	70"	NO	
DSKS17F7212		12"	PIL7X108	7"	WCH72X12	72"	—	56" - 58"	72"	NO	
DSKS18F729		14"	PIL8X108	8"	WCH72X9	72"	—	54" - 56"	72"	NO	
DSKS18F7212		14"	PIL8X108	8"	WCH72X12	72"	—	54" - 56"	72"	NO	

Single Door   2 Sidelites   With Keystone											
Door Style	Part Number	Sidelite Width	Pilaster	Pilaster Width	Crosshead	Crosshead Width	Keystone	Door Unit Width Dimension Range (A)	Outside Dimension of DSK (B)	Crosshead Can be Trimmed	
	DSKS205F746K	10"	PIL5X108	5"	WCH74X6	74"	K6M	Up to 63 1/2"	74"	YES	
	DSKS207F779K	10"	PIL7X108	7"	WCH77X9	77"	K9M	Up to 63"	77"	YES	
	DSKS208F809K	10"	PIL8X108	8"	WCH80X9	80"	K9M	Up to 64"	80"	YES	
	DSKS205F786K	12"	PIL5X108	5"	WCH78X6	78"	K6M	Up to 67 1/2"	78"	YES	
	DSKS207F819K	12"	PIL7X108	7"	WCH81X9	81"	K9M	Up to 67"	81"	YES	
	DSKS208F849K	12"	PIL8X108	8"	WCH84X9	84"	K9M	Up to 68"	84"	YES	
	DSKS25F846K	14"	PIL5X108	5"	WCH84X6	84"	K6M	Up to 73 1/2"	84"	YES	
	DSKS27F869K	14"	PIL7X108	7"	WCH86X9	86"	K9M	Up to 72"	86"	YES	
	DSKS27F9612K	12"	PIL7X108	7"	WCH96X12	96"	K12M	Up to 82"	96"	YES	
	DSKS28F889K	14"	PIL8X108	8"	WCH88X9	88"	K9M	Up to 72"	88"	YES	
	DSKS28F9612K	14"	PIL8X108	8"	WCH96X12	96"	K12M	Up to 80"	96"	YES	
	Single Door   2 Sidelites   Without Keystone										
		DSKS205F746	10"	PIL5X108	5"	WCH74X6	74"	—	61 1/2" - 63 1/2"	74"	NO
		DSKS207F779	10"	PIL7X108	7"	WCH77X9	77"	—	61" - 63"	77"	NO
DSKS208F809		10"	PIL8X108	8"	WCH80X9	80"	—	62" - 64"	80"	NO	
DSKS205F786		12"	PIL5X108	5"	WCH78X6	78"	—	65 1/2" - 67 1/2"	78"	NO	
DSKS207F819		12"	PIL7X108	7"	WCH81X9	81"	—	65" - 67"	81"	NO	
DSKS208F849		12"	PIL8X108	8"	WCH84X9	84"	—	66" - 68"	84"	NO	
DSKS25F846		10"	PIL5x108	5"	WCH84X6	84"	—	71 1/2" - 73 1/2"	84"	NO	
DSKS27F869		14"	PIL7X108	7"	WCH86X9	86"	—	70" - 72"	86"	NO	
DSKS27F9612		12"	PIL7X108	7"	WCH96X12	96"	—	80" - 82"	96"	NO	
DSKS28F889		14"	PIL8X108	8"	WCH88X9	88"	—	70" - 72"	88"	NO	
DSKS28F9612		14"	PIL8X108	8"	WCH96X9	96"	—	78" - 80"	96"	NO	

Double Door   With Keystone										
Door Style	Part Number	Sidelite Width	Pilaster	Pilaster Width	Crosshead	Crosshead Width	Keystone	Door Unit Width Dimension Range (A)	Outside Dimension of DSK (B)	Crosshead Can be Trimmed
	DSKD05F966K	—	PIL5X108	5"	WCH96X6	96"	K6M	Up to 85 1/2"	96"	YES
	DSKD07F939K	—	PIL7X108	7"	WCH93X9	93"	K9M	Up to 79"	93"	YES
	DSKD07F9612K	—	PIL7X108	7"	WCH96X12	96"	K12M	Up to 82"	96"	YES
	DSKD08F969K	—	PIL8X108	8"	WCH96X9	96"	K9M	Up to 80"	96"	YES
	DSKD08F9612K	—	PIL8X108	8"	WCH96X12	96"	K12M	Up to 80"	96"	YES
Double Door   Without Keystone										
	DSKD05F966	—	PIL5x108	5"	WCH96X6	96"	—	83 1/2" - 85 1/2"	96"	NO
	DSKD07F9612	—	PIL7x108	7"	WCH96X12	93"	—	82" - 84"	96"	NO
	DSKD07F939	—	PIL7X108	7"	WCH93X9	93"	—	77" - 79"	93"	NO
	DSKD08F9612	—	PIL8X108	8"	WCH96X12	96"	—	78" - 80"	96"	NO
	DSKD08F969	—	PIL8X108	8"	WCH96X9	96"	—	78" - 80"	96"	NO

Parts may be required to ship LTL (less than truckload) based on size and overall dimensions.



## Modern Farmhouse Shaker-Style Shutters

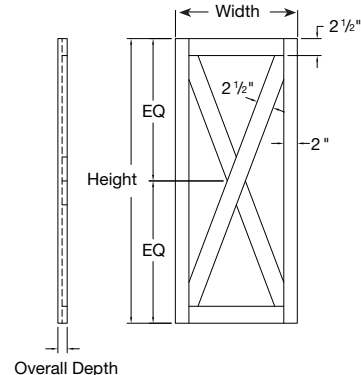

- Available in widths measuring 12", 16", 18" and 24", and heights measuring 24" - 120" in 1" increments.
- 2" wide stiles and 2 1/2" wide batten create the X batten design.
- Stiles 1 3/8" deep with 5/8" recessed panel
- Modern Farmhouse Shaker-style Shutter Panels and Flat Trim are available to meet your design needs (SHSFP12X144, SHSFP16X144, SHSFP18X144, SHSFP24X144, FLT1X3-12).

### Part Number Logic:

<b>SHMFH12X24</b>			
[Profile]			[Height]
SH = Shutter			(1" Increments)
[Configuration]	[Width]		
MFH = Modern Farmhouse style	12 = 12"	24 = 24" [Minimum]	
	16 = 16"	120 = 120" [Maximum]	
	18 = 18"		
	24 = 24"		

Note: Sold in pairs.



## Shaker-Style Shutters

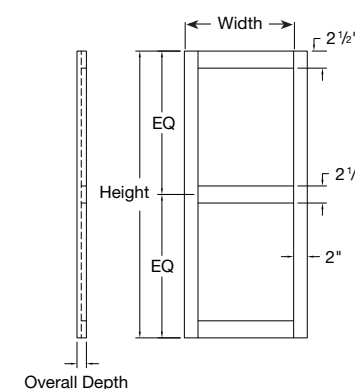

- 2-panel flat recessed stile and rail design.
- Available in widths measuring 12", 16", 18" and 24", and heights measuring 24" - 120" in 1" increments.
- 2" wide stiles with 2 1/2" wide rails. Center rail is positioned in the center of the shutter.
- Stiles 1 3/8" deep with 5/8" recessed panel.
- Shaker-style Shutter Panels and Flat Trim are available to meet your design needs (SHSFP12X144, SHSFP16X144, SHSFP18X144, SHSFP24X144, FLT1X3-12).

### Part Number Logic:

<b>SH2FP12X24</b>			
[Profile]			[Height]
SH = Shutter			(1" Increments)
[Configuration]	[Width]		
2FP = 2 Flat Panel	12 = 12"	24 = 24" [Minimum]	
	16 = 16"	120 = 120" [Maximum]	
	18 = 18"		
	24 = 24"		

Note: Sold in pairs.





# Louvered Shutter

with Center Rail

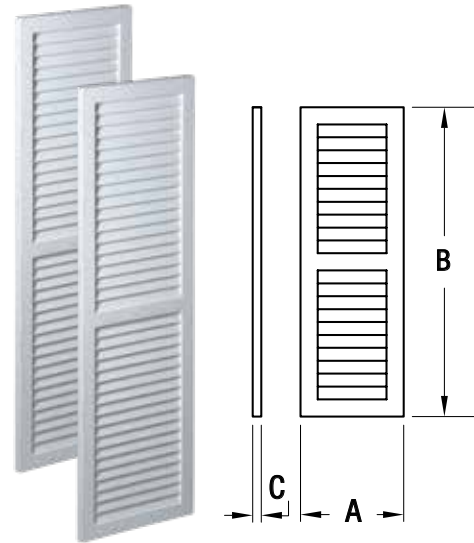

Part Number	Width (A)	Height (B)	Projection (C)
LVSH12X36FNCR	12"	36"	1"
LVSH12X48FNCR	12"	48"	1"
LVSH16X54FNCR	16"	54"	1"
LVSH16X60FNCR	16"	60"	1"
LVSH16X72FNCR	16"	72"	1"
LVSH18X60FNCR	18"	60"	1"
LVSH18X66FNCR	18"	66"	1"
LVSH18X72FNCR	18"	72"	1"
LVSH24X60FNCR	24"	60"	1"
LVSH24X72FNCR	24"	72"	1"

Note: Sold in pairs.

# Raised Panel Shutter

Double Panel

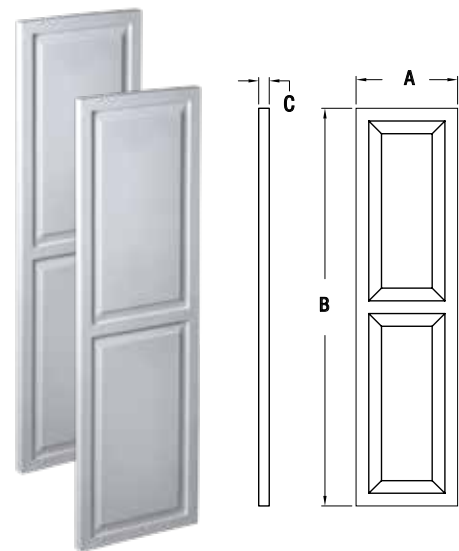

Part Number	Width (A)	Height (B)	Projection (C)
SH16X48DP	16"	48"	1 1/4"
SH16X54DP	16"	54"	1 1/4"
SH16X60DP	16"	60"	1 1/4"
SH16X65DP	16"	65"	1 1/4"
SH16X72DP	16"	72"	1 1/4"
SH18X53DP	18"	53"	1 1/4"
SH18X59DP	18"	59"	1 1/4"
SH18X66DP	18"	66"	1 1/4"
SH18X72DP	18"	72"	1 1/4"

Note: Sold in pairs.

# Louvered Shutter

without Center Rail

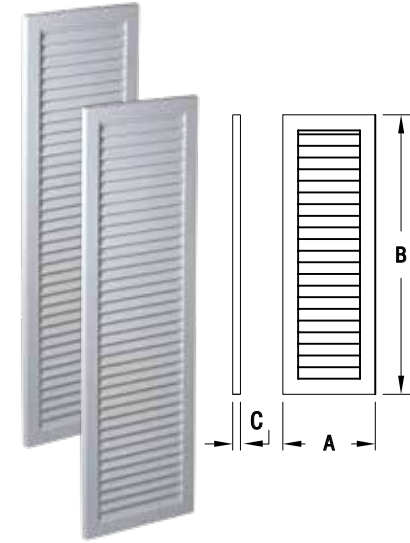

Part Number	Width (A)	Height (B)	Projection (C)
LVSH16X72FNB	16"	72"	1"
LVSH16X54FNB	16"	54"	1"
LVSH18X54FNB	18"	54"	1"
LVSH18X60FNB	18"	60"	1"
LVSH18X72FNB	18"	72"	1"
LVSH24X60FNB	24"	60"	1"
LVSH24X72FNB	24"	72"	1"

Note: Sold in pairs.



Parts may be required to ship LTL (less than truckload) based on size and overall dimensions.



# WOODGRAIN SHUTTERS

## Get the size and style you need.

- Our expanded line includes multiple styles and sizes, with widths measuring 12", 14", 18", and 24", and heights measuring 24"- 120", in 1" increments.
- Accessory line of Hinges and Clavos creates a distinct look for your Shutters.
- Available in both Board & Batten and Plank styles.

### BOARD & BATTEN – JOINED BOARD AND BATTEN STYLES



**2 OR 3 BATTEN**  
Batten styles with joined boards.



**END BATTEN**  
Battens are placed at the very end of the boards.



**Z BATTEN**  
Horizontal and diagonal battens form Z shape.



**QUARTER ROUND**  
Mirrors unique arch top windows.



**ELLIPTICAL**  
Mirrors the shape of unique elliptical windows.

### PLANK – SPACED BOARDS CREATE VISIBILITY OF SIDING BETWEEN SHUTTER BOARDS



**2 OR 3 BATTEN**  
Batten styles with spaced boards.



**Z BATTEN**  
Horizontal and diagonal battens form Z shape.



**DIAMOND**  
Decorative diamond shape is centered between the panels.



**ELLIPTICAL**  
Mirrors the shape of unique elliptical windows.

#### Board & Batten Part Number Logic:

#### Plank Part Number Logic:

SH3PC18X60RS				SH3PO18X60RS			
[Profile]		[Texture]		[Profile]		[Texture]	
SH = Shutter		RS = Rough Sawn Stain or Paint		SH = Shutter		RS = Rough Sawn Stain or Paint	
[Configuration]				[Configuration]			
2PC = 2 Board, 2 Batten	2PZC = 2 Board, Z Batten	2PO = 2 Plank, 2 Batten	2PZ = 2 Plank, Z Batten	2P3B = 2 Plank, 3 Batten	2PD = 2 Plank, Diamond	2P3B = 2 Plank, 3 Batten	2PD = 2 Plank, Diamond
3PC = 3 Board, 2 Batten	3PZC = 3 Board, Z Batten	3PO = 3 Plank, 2 Batten	3PZ = 3 Plank, Z Batten	3P3B = 3 Plank, 3 Batten	3PD = 3 Plank, Diamond	3P3B = 3 Plank, 3 Batten	3PD = 3 Plank, Diamond
4PC = 4 Board, 2 Batten	4PZC = 4 Board, Z Batten	4PO = 4 Plank, 2 Batten	4PZ = 4 Plank, Z Batten	4P3B = 4 Plank, 3 Batten	4PD = 4 Plank, Diamond	4P3B = 4 Plank, 3 Batten	4PD = 4 Plank, Diamond
2P3BC = 2 Board, 3 Batten	2PEBC = 2 Board, End Batten						
3P3BC = 3 Board, 3 Batten	3PEBC = 3 Board, End Batten						
4P3BC = 4 Board, 3 Batten	4PEBC = 4 Board, End Batten						
		[Height] (1" increments)		[Height] (1" increments)		[Width]	
		24 = 24" [Minimum]	120 = 120" [Maximum]	24 = 24" [Minimum]	120 = 120" [Maximum]	12 = 12"	18 = 18"
						24 = 24"	24 = 24"

#### Quarter Round Part Number Logic:

SH3PHLR18X60RS			
[Profile]		[Texture]	
SH = Shutter		RS = Rough Sawn Stain or Paint	
[Configuration]			
2PHLR = 2 Board Quarter			
3PHLR = 3 Board Quarter			
4PHLR = 4 Board Quarter			
		[Height] (1" increments)	
		24 = 24" [Minimum]	120 = 120" [Maximum]
		[Width]	
		12 = 12"	14 = 14"
		18 = 18"	24 = 24"

Note: Minimum height for Quarter Round Shutters is double the width of the Shutter.  
Example: SH3PHLR18x36RS – 18" = width of Shutter and 36" = height (twice the width).





Additional Sizes Available

Shutters measuring 24" - 120", in 1" increments, are available at standard lead time. See page 63 for part number logic.

# 12" Board & Batten Shutters

Rough Sawn Cedar



2 Board, 2 Batten		2 Board, 3 Batten		2 Board, End Batten	
Part Number		Part Number		Part Number	
	SH2PC12X24RS		SH2P3BC12X24RS		SH2PEBC12X24RS
	SH2PC12X36RS		SH2P3BC12X36RS		SH2PEBC12X36RS
	SH2PC12X48RS		SH2P3BC12X48RS		SH2PEBC12X48RS
	SH2PC12X60RS		SH2P3BC12X60RS		SH2PEBC12X60RS
	SH2PC12X72RS		SH2P3BC12X72RS		SH2PEBC12X72RS
	SH2PC12X84RS		SH2P3BC12X84RS		SH2PEBC12X84RS
	SH2PC12X96RS		SH2P3BC12X96RS		SH2PEBC12X96RS
	SH2PC12X108RS		SH2P3BC12X108RS		SH2PEBC12X108RS
	SH2PC12X120RS		SH2P3BC12X120RS		SH2PEBC12X120RS



# 12" Board & Batten Shutters

Rough Sawn Cedar



2 Board, Z Batten		2 Board, Quarter Round	
Part Number		Part Number	
	SH2PZC12X24RS		SH2PHLR12X24RS
	SH2PZC12X36RS		SH2PHLR12X36RS
	SH2PZC12X48RS		SH2PHLR12X48RS
	SH2PZC12X60RS		SH2PHLR12X60RS
	SH2PZC12X72RS		SH2PHLR12X72RS
	SH2PZC12X84RS		SH2PHLR12X84RS
	SH2PZC12X96RS		SH2PHLR12X96RS
	SH2PZC12X108RS		SH2PHLR12X108RS
	SH2PZC12X120RS		SH2PHLR12X120RS

Parts may be required to ship LTL (less than truckload) based on size and overall dimensions.





### Additional Sizes Available

Shutters measuring 24" - 120", in 1" increments, are available at standard lead time. See page 63 for part number logic.

## 14" Board & Batten Shutters



Rough Sawn Cedar

3 Board, 2 Batten		3 Board, 3 Batten		3 Board, End Batten	
Part Number		Part Number		Part Number	
	SH3PC14X24RS		SH3P3BC14X24RS		SH3PEBC14X24RS
	SH3PC14X36RS		SH3P3BC14X36RS		SH3PEBC14X36RS
	SH3PC14X48RS		SH3P3BC14X48RS		SH3PEBC14X48RS
	SH3PC14X60RS		SH3P3BC14X60RS		SH3PEBC14X60RS
	SH3PC14X72RS		SH3P3BC14X72RS		SH3PEBC14X72RS
	SH3PC14X84RS		SH3P3BC14X84RS		SH3PEBC14X84RS
	SH3PC14X96RS		SH3P3BC14X96RS		SH3PEBC14X96RS
	SH3PC14X108RS		SH3P3BC14X108RS		SH3PEBC14X108RS
	SH3PC14X120RS		SH3P3BC14X120RS		SH3PEBC14X120RS



## 14" Board & Batten Shutters

Rough Sawn Cedar

3 Board, Z Batten		3 Board, Quarter Round	
Part Number		Part Number	
	SH3PZC14X24RS		SH3PHLR14X36RS
	SH3PZC14X36RS		SH3PHLR14X48RS
	SH3PZC14X48RS		SH3PHLR14X60RS
	SH3PZC14X60RS		SH3PHLR14X72RS
	SH3PZC14X72RS		SH3PHLR14X84RS
	SH3PZC14X84RS		SH3PHLR14X96RS
	SH3PZC14X96RS		SH3PHLR14X108RS
	SH3PZC14X108RS		SH3PHLR14X120RS
	SH3PZC14X120RS		

Parts may be required to ship LTL (less than truckload) based on size and overall dimensions.

Additional Sizes Available

Shutters measuring 24" - 120", in 1" increments, are available at standard lead time. See page 63 for part number logic.

18" Board & Batten Shutters

Rough Sawn Cedar

3 Board, 2 Batten		3 Board, 3 Batten		3 Board, End Batten	
Image	Part Number	Image	Part Number	Image	Part Number
	SH3PC18X24RS		SH3P3BC18X24RS		SH3PEBC18X24RS
	SH3PC18X36RS		SH3P3BC18X36RS		SH3PEBC18X36RS
	SH3PC18X48RS		SH3P3BC18X48RS		SH3PEBC18X48RS
	SH3PC18X60RS		SH3P3BC18X60RS		SH3PEBC18X60RS
	SH3PC18X72RS		SH3P3BC18X72RS		SH3PEBC18X72RS
	SH3PC18X84RS		SH3P3BC18X84RS		SH3PEBC18X84RS
	SH3PC18X96RS		SH3P3BC18X96RS		SH3PEBC18X96RS
	SH3PC18X108RS		SH3P3BC18X108RS		SH3PEBC18X108RS
	SH3PC18X120RS		SH3P3BC18X120RS		SH3PEBC18X120RS

24" Board & Batten Shutters

Rough Sawn Cedar

4 Board, 2 Batten		4 Board, 3 Batten		4 Board, End Batten	
Image	Part Number	Image	Part Number	Image	Part Number
	SH4PC24X24RS		SH4P3BC24X24RS		SH4PEBC24X24RS
	SH4PC24X36RS		SH4P3BC24X36RS		SH4PEBC24X36RS
	SH4PC24X48RS		SH4P3BC24X48RS		SH4PEBC24X48RS
	SH4PC24X60RS		SH4P3BC24X60RS		SH4PEBC24X60RS
	SH4PC24X72RS		SH4P3BC24X72RS		SH4PEBC24X72RS
	SH4PC24X84RS		SH4P3BC24X84RS		SH4PEBC24X84RS
	SH4PC24X96RS		SH4P3BC24X96RS		SH4PEBC24X96RS
	SH4PC24X108RS		SH4P3BC24X108RS		SH4PEBC24X108RS
	SH4PC24X120RS		SH4P3BC24X120RS		SH4PEBC24X120RS

3 Board, Z Batten		3 Board, Quarter Round	
Image	Part Number	Image	Part Number
	SH3PZC18X24RS		SH3PHLR18X36RS
	SH3PZC18X36RS		SH3PHLR18X48RS
	SH3PZC18X48RS		SH3PHLR18X60RS
	SH3PZC18X60RS		SH3PHLR18X72RS
	SH3PZC18X72RS		SH3PHLR18X84RS
	SH3PZC18X84RS		SH3PHLR18X96RS
	SH3PZC18X96RS		SH3PHLR18X108RS
	SH3PZC18X108RS		SH3PHLR18X120RS
	SH3PZC18X120RS		

4 Board, Z Batten		4 Board, Quarter Round	
Image	Part Number	Image	Part Number
	SH4PZC24X24RS		SH4PHLR24X48RS
	SH4PZC24X36RS		SH4PHLR24X60RS
	SH4PZC24X48RS		SH4PHLR24X72RS
	SH4PZC24X60RS		SH4PHLR24X84RS
	SH4PZC24X72RS		SH4PHLR24X96RS
	SH4PZC24X84RS		SH4PHLR24X108RS
	SH4PZC24X96RS		SH4PHLR24X120RS
	SH4PZC24X108RS		
	SH4PZC24X120RS		

Parts may be required to ship LTL (less than truckload) based on size and overall dimensions.



Additional Sizes Available

Shutters measuring 24" - 120", in 1" increments, are available at standard lead time. See page 63 for part number logic.

# 12" Plank Shutters

Rough Sawn Cedar

2 Plank, 2 Batten		2 Plank, 3 Batten		2 Plank, Z Batten	
Image	Part Number	Image	Part Number	Image	Part Number
	SH2P012X24RS		SH2P3B12X24RS		SH2PZ12X24RS
	SH2P012X36RS		SH2P3B12X36RS		SH2PZ12X36RS
	SH2P012X48RS		SH2P3B12X48RS		SH2PZ12X48RS
	SH2P012X60RS		SH2P3B12X60RS		SH2PZ12X60RS
	SH2P012X72RS		SH2P3B12X72RS		SH2PZ12X72RS
	SH2P012X84RS		SH2P3B12X84RS		SH2PZ12X84RS
	SH2P012X96RS		SH2P3B12X96RS		SH2PZ12X96RS
	SH2P012X108RS		SH2P3B12X108RS		SH2PZ12X108RS
	SH2P012X120RS		SH2P3B12X120RS		SH2PZ12X120RS

# 18" Plank Shutters

Rough Sawn Cedar

3 Plank, 2 Batten		3 Plank, 3 Batten		3 Plank, Z Batten	
Image	Part Number	Image	Part Number	Image	Part Number
	SH3P018X24RS		SH3P3B18X24RS		SH3PZ18X24RS
	SH3P018X36RS		SH3P3B18X36RS		SH3PZ18X36RS
	SH3P018X48RS		SH3P3B18X48RS		SH3PZ18X48RS
	SH3P018X60RS		SH3P3B18X60RS		SH3PZ18X60RS
	SH3P018X72RS		SH3P3B18X72RS		SH3PZ18X72RS
	SH3P018X84RS		SH3P3B18X84RS		SH3PZ18X84RS
	SH3P018X96RS		SH3P3B18X96RS		SH3PZ18X96RS
	SH3P018X108RS		SH3P3B18X108RS		SH3PZ18X108RS
	SH3P018X120RS		SH3P3B18X120RS		SH3PZ18X120RS



# 24" Plank Shutters

Rough Sawn Cedar

4 Plank, 2 Batten		4 Plank, 3 Batten		4 Plank, Z Batten	
Image	Part Number	Image	Part Number	Image	Part Number
	SH4P024X24RS		SH4P3B24X24RS		SH4PZ24X24RS
	SH4P024X36RS		SH4P3B24X36RS		SH4PZ24X36RS
	SH4P024X48RS		SH4P3B24X48RS		SH4PZ24X48RS
	SH4P024X60RS		SH4P3B24X60RS		SH4PZ24X60RS
	SH4P024X72RS		SH4P3B24X72RS		SH4PZ24X72RS
	SH4P024X84RS		SH4P3B24X84RS		SH4PZ24X84RS
	SH4P024X96RS		SH4P3B24X96RS		SH4PZ24X96RS
	SH4P024X108RS		SH4P3B24X108RS		SH4PZ24X108RS
	SH4P024X120RS		SH4P3B24X120RS		SH4PZ24X120RS

Parts may be required to ship LTL (less than truckload) based on size and overall dimensions.



Additional Sizes Available

Shutters measuring 24" - 120", in 1" increments, are available at standard lead time.



Elliptical Shutters - Board & Batten

Rough Sawn Cedar



Part Number Logic:

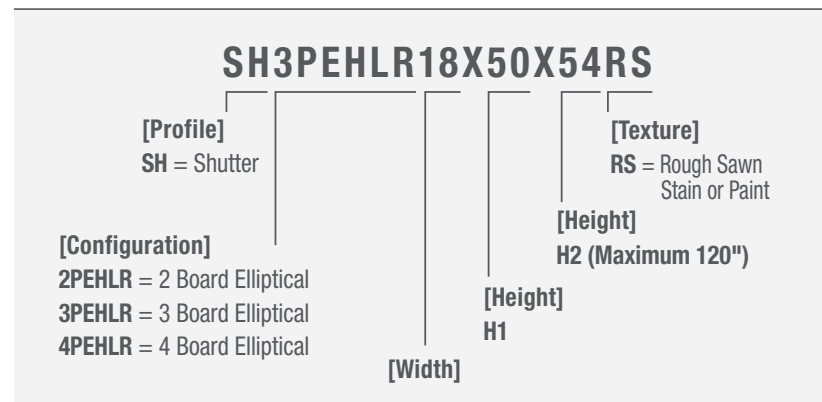

Note: Minimum height (H2) for Elliptical Board & Batten Shutters is double the width of the Shutter.  
Example: SH3PEHLR18X35X36RS - 18" = width of Shutter and 36" = height (twice the width).

Elliptical Shutters - Plank

Rough Sawn Cedar



Part Number Logic:

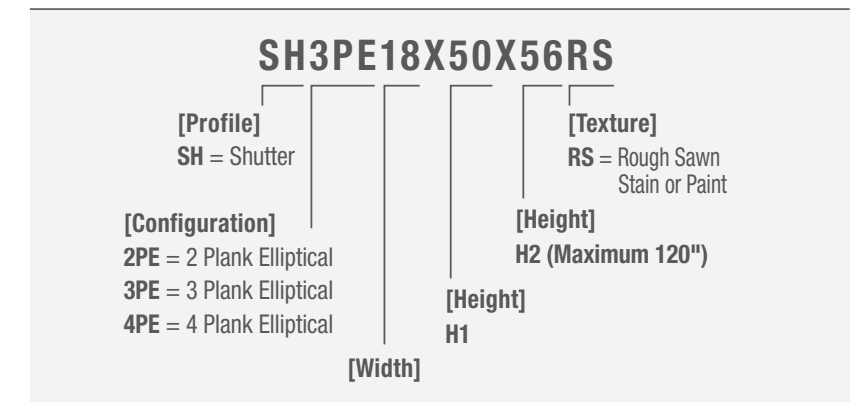

Note: Minimum height (H2) for Elliptical Board & Batten Shutters is double the width of the Shutter.  
Example: SH3PE18X35X36RS - 18" = width of Shutter and 36" = height (twice the width).

To order an Elliptical Board & Batten Shutter that complements the arch of the window, provide measurements of **H1** (in 1/4" increments) and **H2** (in 1" increments) in your part number. See drawing for specific measurement points.

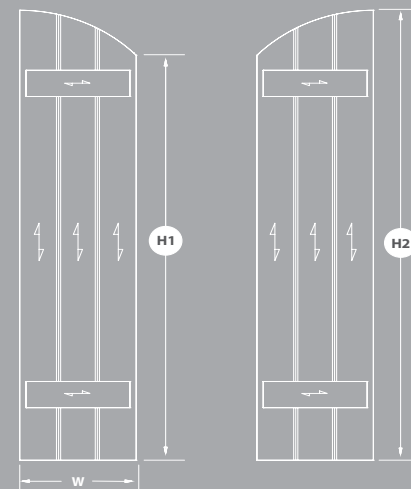

**Example:**  
SH3PEHLR18X50X54RS

W H1 H2

To order an Elliptical Plank Shutter that complements the arch of the window, provide measurements of **H1** (in 1/4" increments) and **H2** (in 1" increments) in your part number. See drawing for specific measurement points.

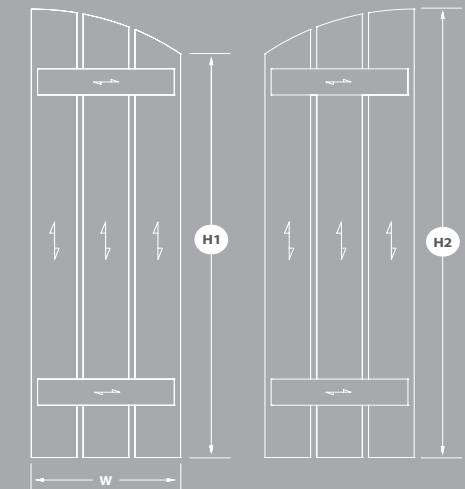

**Example:**  
SH3PE18X50X56RS

W H1 H2

Note: If a specific radius is required to complement an elliptical shaped window, contact your customer service representative to order.





**Additional Sizes Available**

Shutters measuring 24" - 120", in 1" increments, are available at standard lead time. See page 63 for part number logic.

**Diamond Plank Shutters**

Rough Sawn Cedar

2 Plank, Diamond

3 Plank, Diamond

4 Plank, Diamond

Part Number	Part Number	Part Number
SH2PD12X24RS	SH3PD18X24RS	SH4PD24X24RS
SH2PD12X36RS	SH3PD18X36RS	SH4PD24X36RS
SH2PD12X48RS	SH3PD18X48RS	SH4PD24X48RS
SH2PD12X60RS	SH3PD18X60RS	SH4PD24X60RS
SH2PD12X72RS	SH3PD18X72RS	SH4PD24X72RS
SH2PD12X84RS	SH3PD18X84RS	SH4PD24X84RS
SH2PD12X96RS	SH3PD18X96RS	SH4PD24X96RS
SH2PD12X108RS	SH3PD18X108RS	SH4PD24X108RS
SH2PD12X120RS	SH3PD18X120RS	SH4PD24X120RS

**Shutter Accessories - Hinges<sup>^</sup>**

Colonial & Spear

	Part Number	Length		Part Number	Length
	SHHNGCOL10*	10"		SHHNGSPR10*	10"
	SHHNGCOL16*	16"		SHHNGSPR16*	16"

\*Sold in packs of 2. ^Shutter accessories come primed and ready for paint.

**Shutter Accessories - Clavos<sup>^</sup>**

Round & Pyramid

	Part Number	Diameter		Part Number	Width
	SHCLARND1.25*	1 1/4"		SHCLAPYR1.25*	1 1/4"
	SHCLARND1.25 - 8 pack	1 1/4"		SHCLAPYR1.25 - 8 pack	1 1/4"
	SHCLARND1.25 - 12 pack	1 1/4"		SHCLAPYR1.25 - 12 pack	1 1/4"
	SHCLARND1.25 - 18 pack	1 1/4"		SHCLAPYR1.25 - 18 pack	1 1/4"
	SHCLARND1.25 - 24 pack	1 1/4"		SHCLAPYR1.25 - 24 pack	1 1/4"
	SHCLARND1.25 - 100 pack	1 1/4"		SHCLAPYR1.25 - 100 pack	1 1/4"

\*Sold in packs of 2. ^Shutter accessories come primed and ready for paint.



Parts may be required to ship LTL (less than truckload) based on size and overall dimensions.





## Panel Shutter

Woodgrain with Border



Part Number	Width	Height
SH3PB15X46S	15"	46"
SH3PB18X40S	18"	40"
SH3PB18X66S	18"	66"
SH3PB24X54S	24"	54"

Note: Sold in pairs.

## Shutter Louvered Fabrication Panels

Woodgrain

Part Number	Width	Length	Thickness
LVSSNN32X144S	32"	144"	5/8"

Note: Timber Louvered Panels sold in individual sheets.

## Shutter Board Fabrication Panels

Rough Sawn Cedar

Individual Sheet Part Number	Width	Length	Thickness	Contractor Pack Part Number
 SHBB12X144RS 2-Board Panel	12"	144"	3/4"	SHBB12X144RS-CP Contractor Packs sold in packs of 10
 SHBB14X144RS 3-Board Panel	14"	144"	3/4"	SHBB14X144RS-CP Contractor Packs sold in packs of 10
 SHBB18X144RS 3-Board Panel	18"	144"	3/4"	SHBB18X144RS-CP Contractor Packs sold in packs of 10
 SHBB24X144RS 4-Board Panel	24"	144"	3/4"	SHBB24X144RS-CP Contractor Packs sold in packs of 10
 FLT1X4-12RS Batten Trim	3 1/2"	144"	3/4"	—



Parts may be required to ship LTL (less than truckload) based on size and overall dimensions.



# Mouldings



Smooth Flat Trim .....	82
Brickmould .....	83
Woodgrain Flat Trim .....	85
Crown Mouldings .....	86
Crown Mouldings - Dentil.....	94
Crown Mouldings - Decorative.....	96
Crown Mouldings - Lip.....	97
Mouldings - Window & Door .....	100
Mouldings - Base Cap.....	101
Mouldings - Chair Rail.....	104
Mouldings - Fluted .....	108
Mouldings - Dentil .....	109
Mouldings - Assorted .....	112
Moulding Accessories .....	114
Crown Dentil E-Vent™ System.....	115
Combination Crown E-Vent™ System.....	116
Massive Crown E-Vent™ System...	117

## It's all in the details.

Discover a variety of options, ranging from simple to ornate. Our portfolio of beautiful, inspired styles is available in a range of sizes and combinations, ideal for adding character to any home.

**Product Shown:**  
Moulding – MLD569-12  
Flat Trim – FLT162-14





# Mouldings

## How to Use This Section

The products in this section of the catalog are organized by moulding type. You can find a variety of products to match the aesthetics of almost any application conveniently grouped together. Where applicable, groups of Mouldings are further sorted by height, from smallest to largest.

## How to Order

### Moulding Accessories

The accessories shown here are available to help make Moulding installations quick and easy. Rosettes can be used between Moulding lengths to eliminate the need for patching to create smooth seams. All Rosettes are unattached and must be ordered separately.

### Remember to Order Adhesive

A urethane-based adhesive **must** be used on all joint surfaces. See page 252 to order Loctite® PL Premium® Adhesive.\*



## Moulding Applications

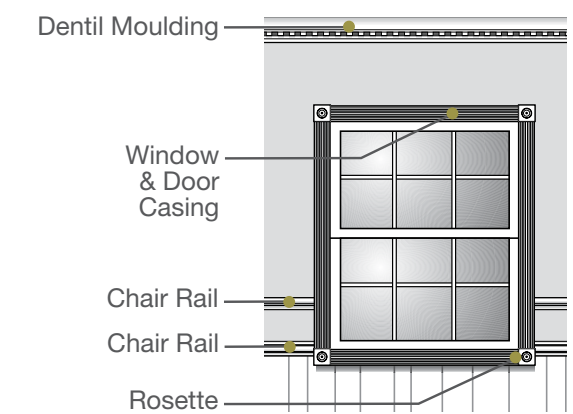
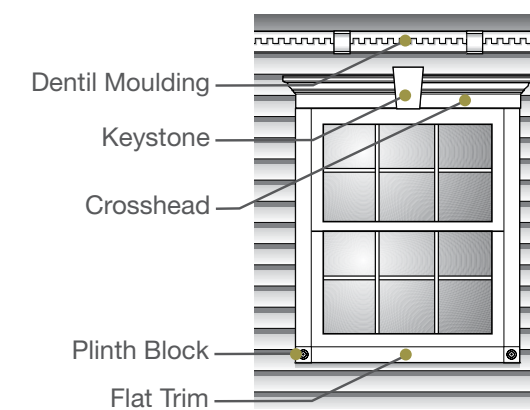

\*Loctite® PL Premium® is owned by Henkel IP & Holding GmbH.



### Change for 2019

All Flat Trim will be sold in packs of 4 instead of individually.

## Smooth Flat Trim

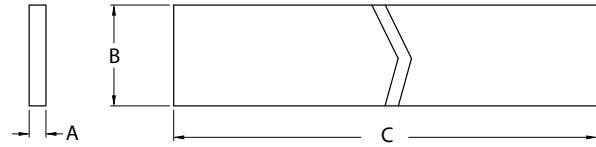

Part Number	Thickness (A)	Width (B)	Length (C)	Accessories
FLT131-16	1/2"	3"	16'	—
FLT178-8	1/2"	14"	8'	—
FLT100-12	5/8"	4 3/4"	12'	—
FLT181-8	5/8"	24"	8'	—
FLT1X3-12	3/4"	2 1/2"	12'	—
FLT101-12	3/4"	1 1/2"	12'	—
FLT102-10	3/4"	2 1/8"	10'	—
FLT103-12	3/4"	3"	12'	PB3X3, PB4X4
FLT122-16	3/4"	3 1/2"	16'	—
FLT110-16	3/4"	5 1/2"	16'	—
FLT109-12	3/4"	6"	12'	—
FLT186-16	3/4"	7 1/4"	16'	—
FLT113-8	3/4"	8"	8'	—
FLT118-8	3/4"	10"	8'	—
FLT152-8	1"	3 1/2"	8'	4F Arches
FLT152-12	1"	3 1/2"	12'	4F Arches
FLT152-16	1"	3 1/2"	16'	4F Arches
FLT153-12	1"	4"	12'	—
FLT159-8	1"	5 1/2"	8'	6F Arches, PB6X6
FLT159-12	1"	5 1/2"	12'	6F Arches, PB6X6
FLT159-16	1"	5 1/2"	16'	6F Arches, PB6X6
FLT162-8	1"	7 1/2"	8'	PB7X7, K8TF
FLT162-14	1"	7 1/2"	14'	PB7X7, K8TF
FLT170-12	1"	9 1/2"	12'	—
FLT170-16	1"	9 1/2"	16'	—
FLT172-16	1"	11 1/2"	16'	—

Note: In order by thickness.





## Smooth Flat Trim

Part Number	Thickness (A)	Width (B)	Length (C)	Accessories
FLT175-12	1"	12"	12'	—
FLT179-12	1"	16"	12'	—
FLT180-12*	1"	24"	12'	—
FLT119-17*	1"	32 1/4"	16' 11"	—
FLT125-8*	1"	36"	8'	—
FLT40X96**	1"	40"	8'	—
FLT194-10	1 1/2"	3 1/2"	10'	—
FLT183-12	1 1/2"	5 1/2"	12'	—
FLT163-16	1 1/2"	7 1/2"	16'	—
FLT182-12	1 1/2"	12 1/4"	12'	—
FLT185-12*	1 1/2"	16 1/2"	12'	—
FLT190-12	2"	4"	12'	—

\*Sold in quantities of 1 per box.  
\*\*Sold in quantities of 2 per box.

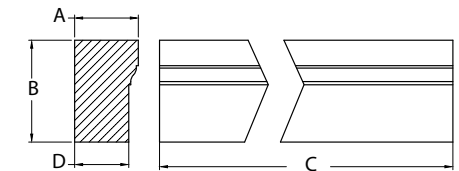
## Brickmould



Part Number	Projection (A)	Height (B)	Length (C)	Bottom Thickness (D)	Accessories
MLDWM180-8	1 1/4"	2"	8'	1 1/2"	 Keystone KWM180M Page 53
MLDWM180-16	1 1/4"	2"	16'	1 1/2"	
MLDWM181-16	3/4"	2"	16'	5/8"	
MLDWM182-12	1 1/4"	3"	12'	1 1/8"	

Parts may be required to ship LTL (less than truckload) based on size and overall dimensions.





## Woodgrain Flat Trim

Change for 2019

All Flat Trim will be sold in packs of 4 instead of individually.



Part Number	Thickness (A)	Width (B)	Length
FLT1X4-12RS	3/4"	3 1/2"	12'
FLT151-12S	3/4"	3 1/2"	12'
FLT110-12S	3/4"	5 1/2"	12'
FLT187-12S	3/4"	7 1/2"	12'
FLT173-12S	3/4"	11 1/2"	12'
FLT30X228X1S*	1"	30"	19'
FLT150-12S	1 1/2"	3 1/2"	12'
FLT111-12S	1 1/2"	5 1/2"	12'
FLT197-12S	1 1/2"	7 1/2"	12'
FLT192-12S	1 1/2"	11 1/2"	12'
FLT9X4X216S**	3 1/2"	8 1/2"	18'

Note: In order by thickness.

\*Sold in quantities of 1 per box.

\*\*Sold in quantities of 2 per box.

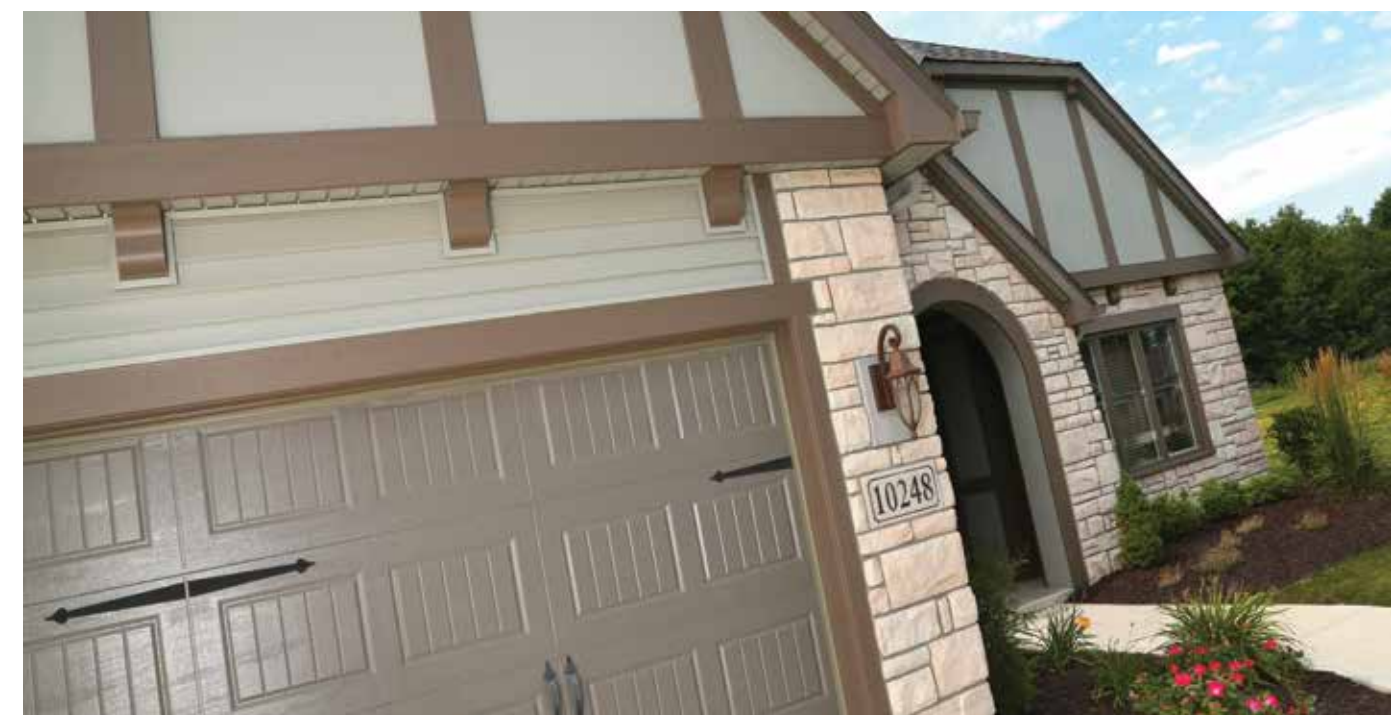

Parts may be required to ship LTL (less than truckload) based on size and overall dimensions.







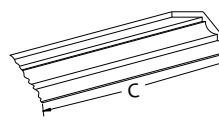
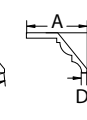

# Crown Mouldings

	Part Number	Projection (A)	Height (B)	Length (C)	Bottom Thickness (D)		
	MLD593-16	2 1/2"	2 1/2"	16'	1/4"		
	MLD451-16	3 1/8"	3"	16'	1/2"		
	MLD452-12	2"	3"	12'	1/4"		
	MLD552-12	2 1/8"	3 1/2"	12'	3/8"		
	MLD592-16	3 3/4"	3 7/8"	16'	1/4"		
	MLD454-12	3 5/8"	4 1/8"	12'	1/4"		
	MLD572-16	3 1/4"	4 1/4"	16'	5/8"		
	MLD456-16	2 3/4"	4 3/8"	16'	1/4"		

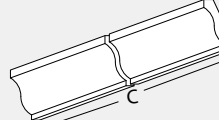
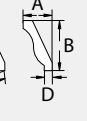

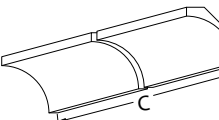
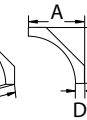

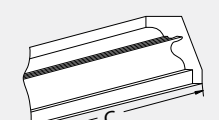
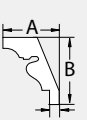





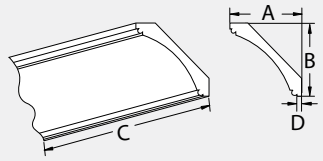

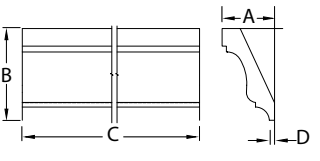
# Crown Mouldings

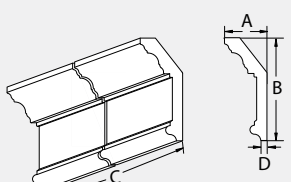

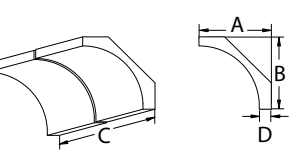
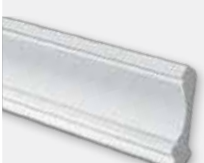
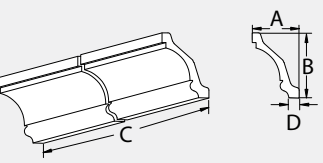

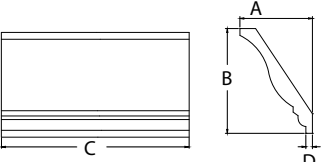

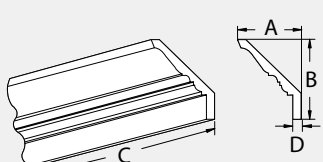



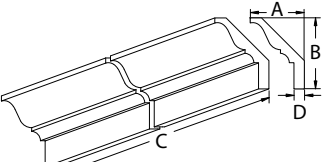

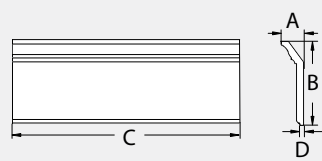

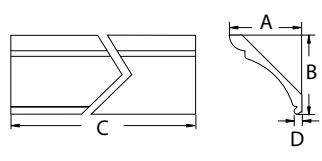
	Part Number	Projection (A)	Height (B)	Length (C)	Bottom Thickness (D)		
	MLD471-12	7 1/8"	4 5/8"	12'	5/8"		
	MLD467-16	2 3/4"	4 3/4"	16'	3/4"		
	MLD584-16	4 3/4"	4 3/4"	16'	3/4"		
	MLD460-12	4 3/8"	5 1/8"	12'	3/4"		

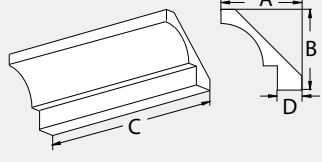
Parts may be required to ship LTL (less than truckload) based on size and overall dimensions.

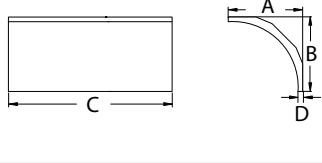
# Crown Mouldings

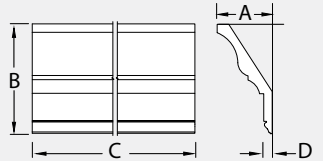
	Part Number	Projection (A)	Height (B)	Length (C)	Bottom Thickness (D)	
	MLD606-12	5 1/4"	5 1/4"	12'	1/4"	
	MLD1037-12	3 3/8"	5 5/8"	12'	1/4"	
	MLD587-16	2 3/8"	5 3/4"	16'	3/8"	
	MLD590-16	6"	6 1/4"	16'	1"	
	MLD589-16	4 3/8"	6 1/2"	16'	1 1/8"	
	MLD453-16	4 3/4"	6 3/4"	16'	1/2"	
	MLD570-12	5 1/2"	6 7/8"	12'	3/4"	

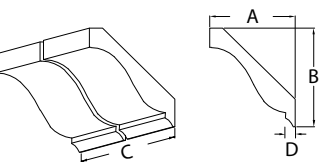

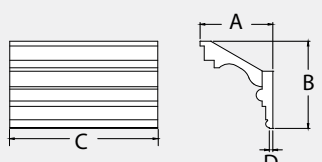







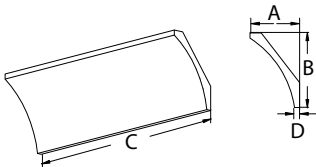

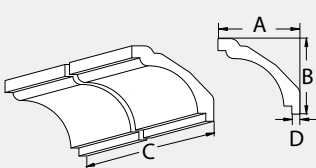

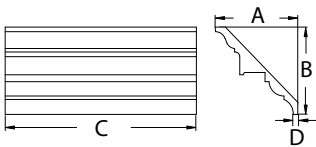
# Crown Mouldings

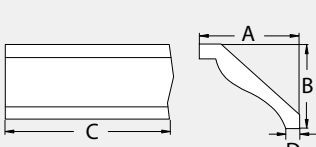
	Part Number	Projection (A)	Height (B)	Length (C)	Bottom Thickness (D)	
	MLD569-12	5 3/4"	7 1/2"	12'	1 1/8"	
	MLD253-16	2 3/8"	7 5/8"	16'	3/8"	
	MLD457-12	6 7/8"	7 5/8"	12'	3/4"	
	MLD582-12	7 7/8"	7 7/8"	12'	2 3/8"	
	MLD583-16	8"	8"	16'	1/2"	
	MLD1001-12	4 1/8"	8 1/8"	12'	1/8"	
	MLD1002-12	5 1/8"	10 1/8"	12'	1/8"	
	MLD449-16	7 1/8"	8 1/2"	16'	1/8"	
	MLD480-12 Ships in 2 pieces	7 7/8"	8 7/8"	12'	3/8"	

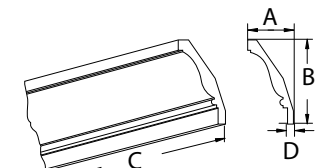
Parts may be required to ship LTL (less than truckload) based on size and overall dimensions.



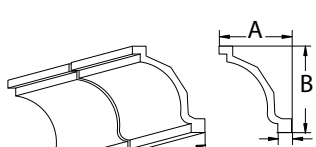









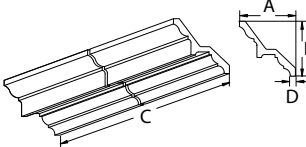
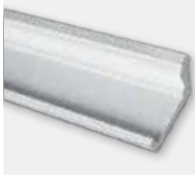
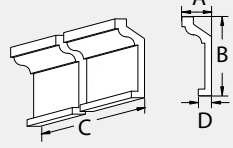

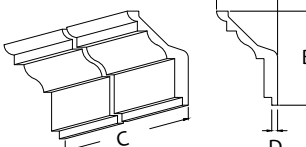
# Crown Mouldings

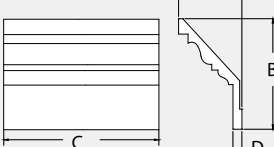
	Part Number	Projection (A)	Height (B)	Length (C)	Bottom Thickness (D)	
	MLD635-12	6"	9"	12'	5/8"	
	MLD591-16	10 1/4"	9 1/2"	16'	1"	
	MLD535-16	9"	9 1/2"	16'	1/2"	
	MLD450-16	11 1/2"	9 5/8"	16'	1 1/2"	
	MLD555-12	5 1/4"	10 3/4"	12'	7/8"	
	MLD371-16	6 1/2"	11"	16'	1"	
	MLD588-16	9 1/4"	11"	16'	1 3/4"	
	MLD364-12	8 3/4"	11 1/4"	12'	1"	

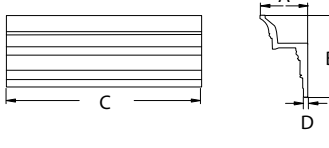
Parts may be required to ship LTL (less than truckload) based on size and overall dimensions.

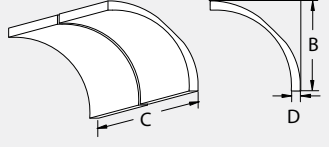

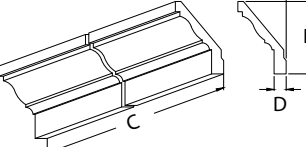

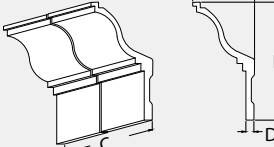

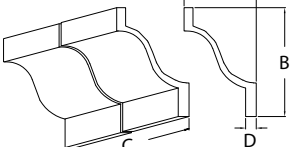

# Crown Mouldings

	Part Number	Projection (A)	Height (B)	Length (C)	Bottom Thickness (D)	
	MLD642-12	12"	11 3/4"	12'	1 3/8"	
	MLD539-16	4 1/2"	12"	16'	2"	
	MLD524-16	8"	12 1/8"	16'	1"	
	MLD580-12	7 1/8"	12 3/8"	12'	1"	
	MLD372-14	8 1/4"	13 7/8"	14'	3/4"	
	MLD734-12	14 3/8"	14 3/8"	12'	1 1/4"	
	MLD556-16	10"	15"	16'	2 1/2"	
	MLD536-12	8 1/8"	15 1/2"	12'	1"	

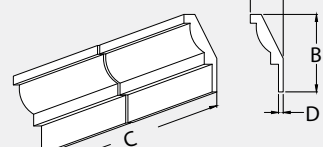

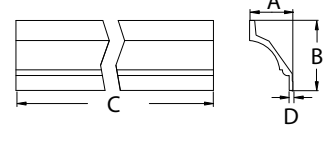
# Crown Mouldings

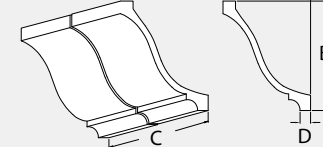







	Part Number	Projection (A)	Height (B)	Length (C)	Bottom Thickness (D)	
	MLD528-12	9 1/2"	15 3/4"	12'	1 1/2"	
	MLD586-16	7"	16 1/2"	16'	1"	
	MLD585-12	10 1/2"	17"	12'	7/8"	
	MLD481-12	14"	17 1/2"	12'	1 3/4"	

Parts may be required to ship LTL (less than truckload) based on size and overall dimensions.



# Crown Mouldings

Dentil

Part Number	Projection (A)	Height (B)	Length (C)	Bottom Thickness (D)	Design Repeat	Tooth & Space
 MLD404-16	2 1/2"	3 7/8"	16'	1/4"	1 1/2"	3/4" Tooth 3/4" Space
 MLD406-16	3 3/8"	4"	16'	3/8"	2"	1 1/4" Tooth 3/4" Space
 MLD365-16	5"	5"	16'	3/8"	4 5/8"	2 1/4" Tooth 2 3/8" Space
 MLD410-12	3 1/4"	6 7/8"	12'	1/2"	3"	1 1/2" Tooth 1 1/2" Space
 MLD411-16	4 1/2"	7"	16'	1/2"	3"	1 1/2" Tooth 1 1/2" Space
 MLD440-12	6 1/2"	7 1/4"	12'	3/8"	6 5/8"	4" Tooth 2 5/8" Space
 MLD430-12	5 3/4"	8"	12' 2 1/4"	1/4"	2 5/8"	1 3/4" Tooth 7/8" Space
 MLD362-16	5 1/8"	8 3/8"	16'	1 1/4"	4 1/2"	2" Tooth 2 1/2" Space
 MLD336-16	3 1/8"	9 3/8"	16' 1"	3/4"	5"	2 1/2" Tooth 2 1/2" Space



# Crown Mouldings

Dentil







Part Number	Projection (A)	Height (B)	Length (C)	Bottom Thickness (D)	Design Repeat	Tooth & Space
 MLD435-16	9"	10"	16'	3/4"	7 3/8"	3 7/8" Tooth 3 1/2" Space
 MLD412-16	5 3/8"	10 5/8"	16'	1/2"	4"	3" Tooth 1" Space
 MLD413-12	8 1/2"	11 1/8"	12'	1 1/2"	5 5/8"	3" Tooth 2 5/8" Space
 MLD419-12	6 3/4"	14 1/2"	12'	1 3/8"	3"	1 1/2" Tooth 1 1/2" Space
 MLD421-12	10"	14 1/2"	12'	3/4"	6"	2" Tooth 4" Space
 MLD461-8	9 7/8"	19"	8'	1"	2 1/2"	1 1/2" Tooth 1" Space

Parts may be required to ship LTL (less than truckload) based on size and overall dimensions.

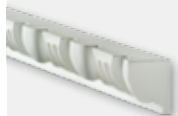

## Crown Mouldings

Decorative

Part Number	Projection (A)	Height (B)	Length (C)	Bottom Thickness (D)	Design Repeat
 MLD562-8 Egg & Dart	2 3/8"	3"	8' 5"	1/2"	6 1/8"
 MLD600-10 Florentine	3/4"	4 1/4"	10'	1/4"	5 5/8"
 MLD490-12 Florentine	6"	5 1/2"	11' 5"	1/4"	—
 MLD640-8 Scalloped	1"	5 3/4"	8'	1"	6"
 MLD493-12 Crown Leaf	5 1/2"	6 5/8"	12'	3/8"	4"
 MLD732-12	4 3/4"	7 1/4"	12'	5/8"	5 3/8"
 MLD425-12	4 1/8"	9 1/2"	11' 5"	3/4"	13 1/2"

5/8" Tooth, 13/16" Space

## Crown Mouldings

Lip









Part Number	Projection (A)	Height (B)	Length (C)	Bottom Thickness (D)
 MLD240-16	3 1/4"	4"	8'	3/4"
 MLD513-16	4 1/8"	4 3/8"	16'	3/4"
 MLD523-16	2"	5 1/4"	16'	1/2"
 MLD509-16	3 1/4"	5 3/8"	16'	1 3/4"
 MLD510-12	4 3/8"	5 1/2"	12'	5/8"
 MLD226-10	1 1/2"	5 1/2"	10'	3/4"
 MLD226-12	1 1/2"	5 1/2"	12'	3/4"
 MLD226-16	1 1/2"	5 1/2"	16'	3/4"
 MLD511-12	5 3/4"	6 1/2"	12'	3/4"
 MLD548-16	3 1/8"	7 1/2"	16'	1 1/8"

Parts may be required to ship LTL (less than truckload) based on size and overall dimensions.

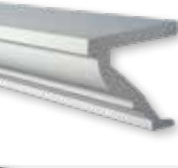

# Crown Mouldings





Lip

Part Number	Projection (A)	Height (B)	Length (C)	Bottom Thickness (D)
 MLD527-16	3 1/2"	7 5/8"	16'	1"
 MLD311-16	5 3/8"	7 3/4"	16'	2 3/8"
 MLD520-16	6 1/8"	8 1/8"	16'	1 7/8"
 MLD508-12	3 5/8"	8 3/8"	12'	1 1/8"
 MLD547-16	5 3/8"	8 5/8"	16'	1 1/2"
 MLD545-12	10"	9 1/8"	12'	2 7/8"
 MLD512-16	8 1/2"	12 1/8"	16'	2 1/8"
 MLD505-8 Massive Fascia	3 3/8"	13"	8'	1"
 MLD521-8	5"	13 1/8"	8'	1"



# Crown Mouldings

Lip







Part Number	Projection (A)	Height (B)	Length (C)	Bottom Thickness (D)
 MLD472-12	11 1/4"	15 1/2"	12'	1 1/8"
 MLD506-16	3"	16 3/8"	16'	7/8"
 MLD533-12	5 1/2"	17"	12'	2 1/2"
 MLD543-12	8 1/4"	19"	12'	1/2"
 MLD534-12	8 7/8"	19 1/8"	12'	1/2"

Parts may be required to ship LTL (less than truckload) based on size and overall dimensions.

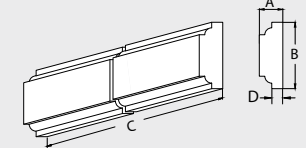
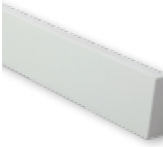
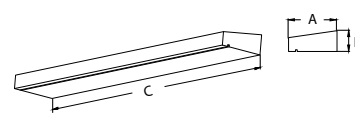

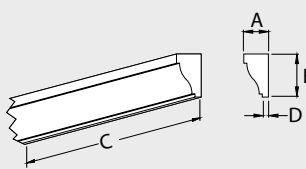

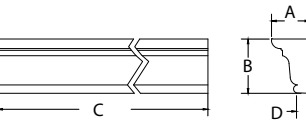

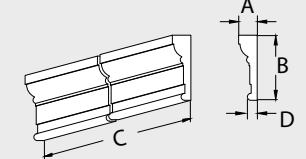





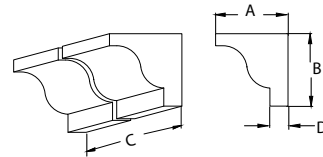

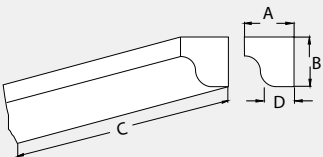

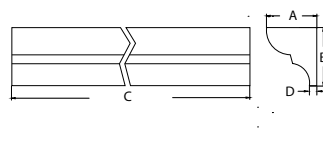
## Mouldings

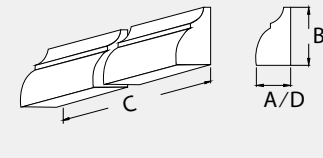
Window & Door

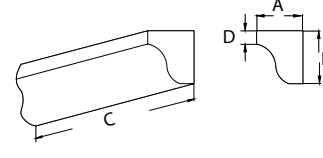
Part Number	Projection (A)	Height (B)	Length (C)	Bottom Thickness (D)	
 MLD637-16 Flat Astragal	1/2"	1 1/2"	16'	3/4"	
 MLD710-10 Sill	3 1/2"	1 1/2" Tapers to 1"	10'	—	
 MLD231-12 Window & Door Casing	1"	1 3/4"	12'	1/4"	
 MLD214-12 Window & Door Casing	2"	2 7/8"	12'	3/4"	
 MLD234-16 Window & Door Casing	1"	3 1/2"	16'	3/8"	

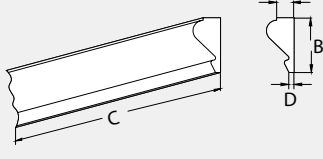
## Mouldings

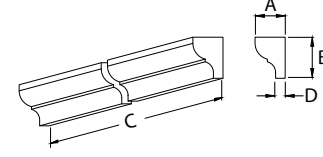
Base Cap

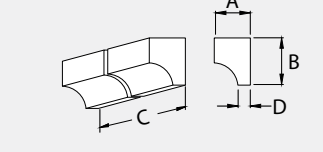









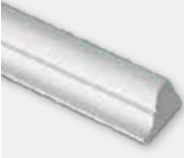
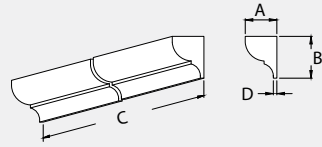

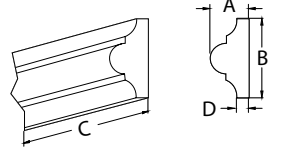
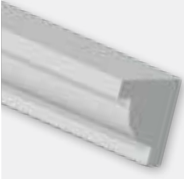
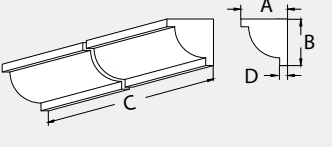
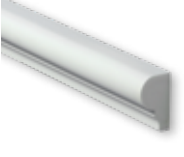
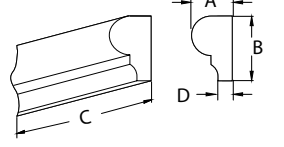
Part Number	Projection (A)	Height (B)	Length (C)	Bottom Thickness (D)	
 MLD633-8	3/4"	3/4"	8'	1/4"	
 MLD602-8 Crosshead Trim Strip	3/4"	3/4"	8'	1/4"	
 MLD626-8	1 1/8"	1 1/4"	8'	1/8"	
 MLD618-16 Base Cap	1"	1 1/2"	16'	1"	
 MLD601-12	1 1/4"	1 1/2"	12'	3/8"	
 MLD612-12	3/4"	1 3/8"	12'	1/8"	
 MLD634-16	1 3/8"	1 7/8"	16'	1/4"	
 MLD627-16	1 5/8"	2 1/8"	16'	1/2"	

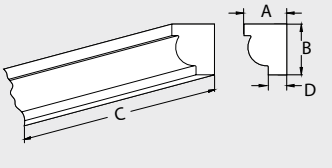
Parts may be required to ship LTL (less than truckload) based on size and overall dimensions.

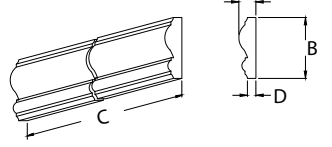

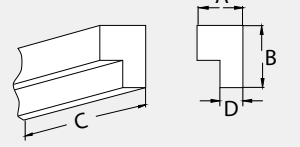
# Mouldings

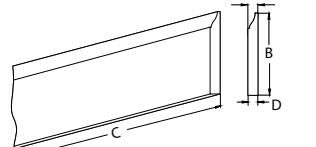
Base Cap

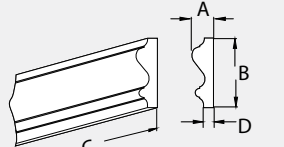



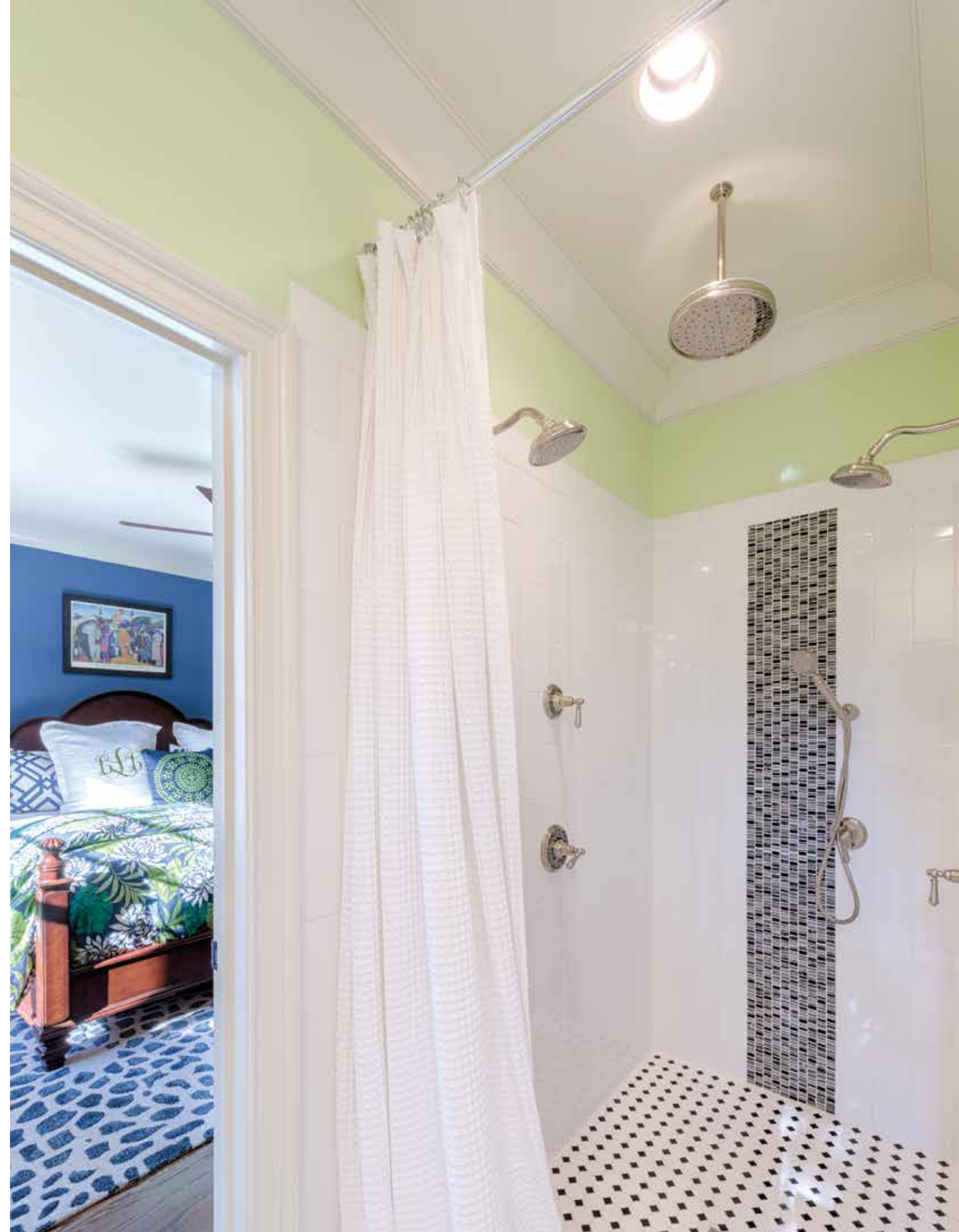





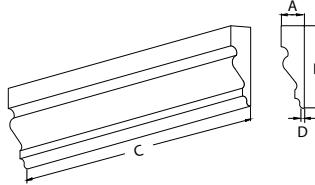

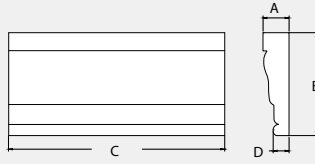

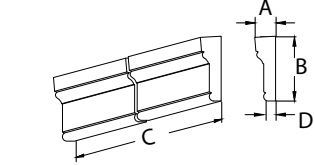
	Part Number	Projection (A)	Height (B)	Length (C)	Bottom Thickness (D)	
	MLD649-16	1 1/2"	2 1/8"	16'	3/8"	
	MLD611-12	1 1/8"	2 1/4"	12'	3/8"	
	MLD629-10	2 1/4"	2 1/4"	10'	3/8"	
	MLD610-8	1 1/2"	2 3/8"	8'	1/2"	
	MLD613-12	2 3/8"	2 3/4"	12'	1"	
	MLD631-16	7/8"	3"	16'	1/2"	
	MLD625-16	3"	4"	16'	1 1/2"	
	MLD706-16 Base Trim	5/8"	5 1/4"	16'	—	
	MLD614-16	1 5/8"	5 1/2"	16'	3/4"	

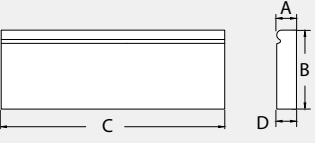
Parts may be required to ship LTL (less than truckload) based on size and overall dimensions.

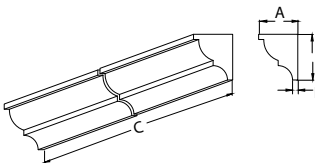

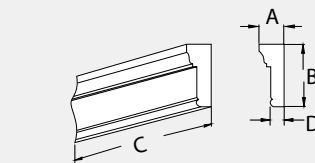
# Mouldings

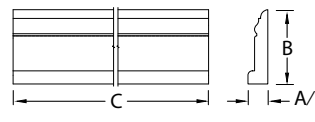
Chair Rail

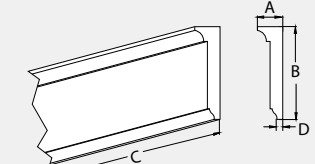
Part Number	Projection (A)	Height (B)	Length (C)	Bottom Thickness (D)	
 MLD621-16	1/2"	2"	16'	1/8"	
 MLD230-16	3/4"	3 1/4"	16'	1/2"	
 MLD237-16	1 1/8"	3 1/2"	16'	3/8"	
 MLD715-16 Beaded	1"	4"	16'	—	
 MLD641-16	3 3/4"	4 3/8"	16'	1/2"	
 MLD250-8	1 3/4"	4 1/2"	8'	1"	
 MLD250-12	1 3/4"	4 1/2"	12'	1"	
 MLD1019-12	1 1/8"	5 1/4"	12'	1 1/8"	
 MLD1020-12	1 1/8"	7 1/4"	12'	1 1/8"	
 MLD224-12	1 1/2"	5 1/2"	12'	3/8"	

# Mouldings

Chair Rail

Part Number	Projection (A)	Height (B)	Length (C)	Bottom Thickness (D)	Accessories	
 MLD236-16	2"	5 1/2"	16'	1 1/4"		
 MLD220-12 6M Profile	1 3/4"	5 1/2"	12'	3/4"	K6TM KP6TM	
 MLD220-16 6M Profile	1 3/4"	5 1/2"	16'	3/4"		
 MLD639-16	1 7/8"	6 1/4"	16'	—	—	
 MLD221-8	1 3/4"	7"	8'	3/4"	—	
 MLD221-16	1 3/4"	7"	16'	3/4"	—	
 MLD705-16 Cove	3/4"	7 1/2"	16'	—	—	
 MLD735-16 Beaded	1"	7 1/2"	16'	—	—	
 MLD232-16	1 1/2"	7 7/8"	16'	1 1/8"	—	











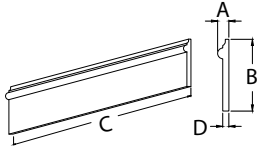

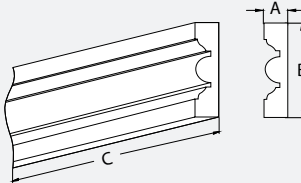

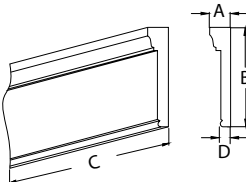
Parts may be required to ship LTL (less than truckload) based on size and overall dimensions.

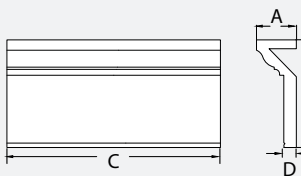

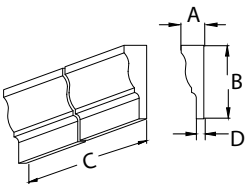

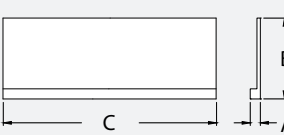
# Mouldings

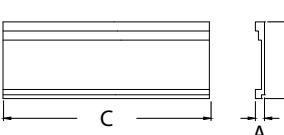
## Chair Rail

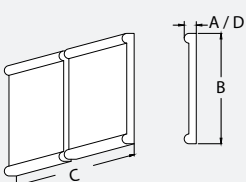

	Part Number	Projection (A)	Height (B)	Length (C)	Bottom Thickness (D)	
	MLD247-16	1 3/8"	8 3/4"	16'	3/4"	
	MLD245-12	2"	8 3/4"	12'	—	
	MLD227-16	1 1/2"	9"	16'	3/4"	
	MLD246-16	3 3/8"	9 1/8"	16'	1"	
	MLD644-16	3"	9 3/4"	16'	1"	
	MLD531-8 Matches MLD530-8	1 1/2"	12"	8'	—	
	MLD530-8 Matches MLD531-8	1 1/2"	12 5/8"	8'	—	
	MLD522-16 Sign Fascia	1 5/8"	14 3/4"	16'	1 5/8"	

Parts may be required to ship LTL (less than truckload) based on size and overall dimensions.







## Mouldings

Fluted

Part Number	Projection (A)	Height (B)	Length (C)	Bottom Thickness (D)	Accessories
 MLD205-12	7/8"	3"	12'	—	PB3X3, PB4X4
 MLD207-16	1"	5 1/4"	16'	1"	PB6X6
 MLD208-16	1"	7 1/4"	16'	1"	—

## Mouldings

Dentil







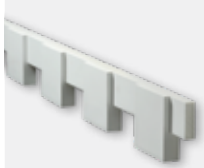
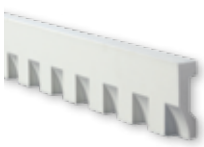

Part Number	Projection (A)	Height (B)	Length (C)	Bottom Thickness (D)	Design Repeat	Tooth & Space
 MLD303-5 WCHX6 Dentil Trim	5/8"	1 1/4"	5'	1/4"	1 1/2"	3/4" Tooth 3/4" Space
 MLD304-8 WCHX9 Dentil Trim	5/8"	1 1/4"	8'	1/4"	2 1/2"	1 1/4" Tooth 1 1/4" Space
 MLD313-8	2 1/4"	2 3/8"	8'	1/4"	2"	1" Tooth 1" Space
 MLD355-8	5/8"	2 1/2"	8' 3/8"	—	2 1/8"	1 3/8" Tooth 3/4" Space
 MLD354-12	1"	3 1/8"	12' 2 1/4"	—	3 1/4"	1 5/8" Tooth 1 5/8" Space
 MLD351-8	1 1/4"	3 1/4"	8' 2"	—	7"	3 1/2" Tooth 3 1/2" Space
 MLD350-8	7/8"	3 1/2"	8' 3 3/4"	1/2"	3 3/4"	2 3/16" Tooth 1 1/2" Space
 MLD352-8	2"	3 1/2"	8' 3 3/4"	—	3 3/4"	2 1/4" Tooth 1 1/2" Space

Parts may be required to ship LTL (less than truckload) based on size and overall dimensions.

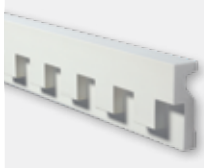

# Mouldings



Dentil

Part Number	Projection (A)	Height (B)	Length (C)	Bottom Thickness (D)	Design Repeat	Tooth & Space
 MLD360-8	3 1/2"	3 3/4"	8'	—	8"	3 3/4" Tooth 4 3/8" Space
 MLD353-8	1 1/4"	4 1/2"	8' 1/4"	—	8 3/4"	4 3/8" Tooth 4 3/8" Space
 MLD310-8	1 1/4"	4 1/2"	8'	1/2"		1 1/2" Tooth
 MLD310-12	1 1/4"	4 1/2"	12'	1/2"	3"	1 1/2" Tooth
 MLD310-16	1 1/4"	4 1/2"	16'	1/2"		1 1/2" Tooth
 MLD332-8	1 5/8"	5"	8'	7/8"	4"	2" Tooth 2" Space
 MLD320-8	1 5/8"	5 3/4"	8'	3/8"		2 3/8" Tooth
 MLD320-12	1 5/8"	5 3/4"	12'	3/8"	4 1/2"	2 1/4" Space
 MLD320-16	1 5/8"	5 3/4"	16' 1 1/2"	3/8"		2 1/4" Space
 MLD335-12	3 3/8"	6 1/8"	12'	1/2"	7 1/4"	3 1/8" Tooth 4 1/4" Space
 MLD330-12	1 5/8"	7"	12'	7/8"	4"	2" Tooth 2" Space
 MLD370-8	6 1/2"	7 1/2"	8'	1"	19 1/4"	4 3/4" Tooth 14 1/2" Space

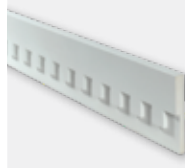
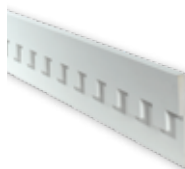

# Mouldings

Dentil

Part Number	Projection (A)	Height (B)	Length (C)	Bottom Thickness (D)	Design Repeat	Tooth & Space
 MLD331-16	1 3/8"	9 1/2"	16' 1 1/2"	3/4"	4 1/2"	2 1/4" Tooth 2 1/4" Space
 MLD333-12	1 3/16"	11 1/2"	12' 4 1/2"	5/8"	5 1/2"	2 3/4" Tooth 2 3/4" Space
 MLD434-16	3 3/4"	16"	15' 9"	1/8"	21"	9" Tooth 12" Space







Note: Part comes with routed channel as shown in profile line art.

Parts may be required to ship LTL (less than truckload) based on size and overall dimensions.



# Mouldings

Assorted

Part Number	Projection (A)	Height (B)	Length (C)	Bottom Thickness (D)	Accessories
 MLD603-8 Quarter Round	1/2"	1/2"	8'	3/4"	—
 MLD628-8 Cove	3/4"	3/4"	8'	1/4"	—
 MLD730-8 Stop	7/8"	1"	8'	1/4"	—
 MLD607-8 Corner Strip	2 1/4"	2 1/4"	8'	3/4"	—
 MLD660-10 Cove	2 3/8"	2 3/8"	10'	—	—
 MLD215-12 4M Profile	1 3/4"	3 1/2"	12'	3/4"	K4TM KP4TM
 MLD605-12 Half Round	1 3/4"	3 1/2"	12'	—	—

Parts may be required to ship LTL (less than truckload) based on size and overall dimensions.

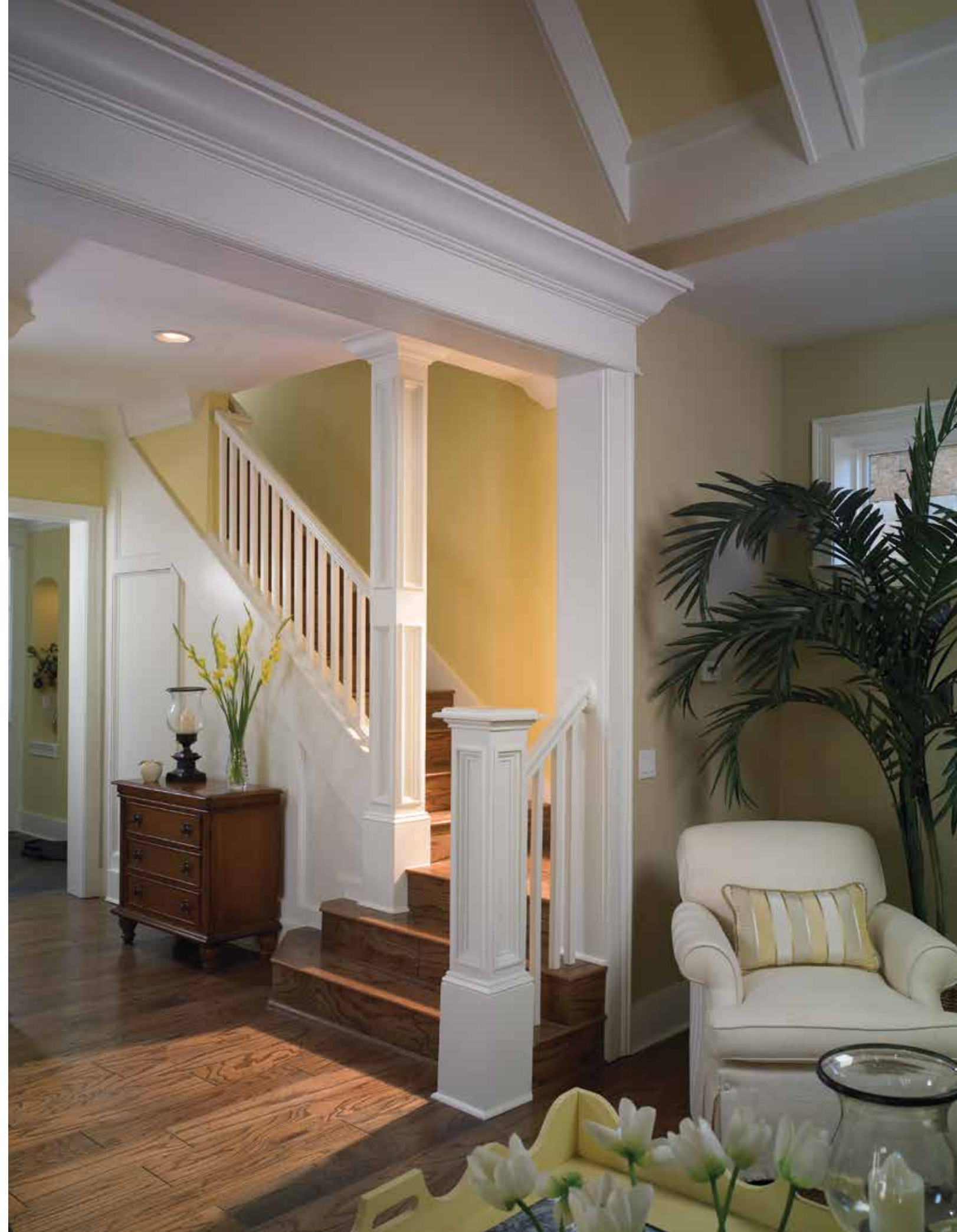



# Moulding Accessories





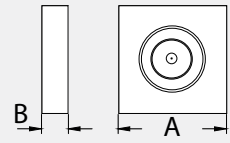



Rosettes / Plinth Blocks

Part Number	Width (A)	Projection (B)	Matching Parts
PB2.5X2.5	2 1/2"	3/4"	—
PB3X3	3 5/8"	7/8"	FLT103 MLD205
PB3.5X3.5	3 1/2"	3/4"	—
PB3.875X3.875	3 7/8"	1 1/8"	—
PB4X4	3 5/8"	1 1/8"	FLT103 MLD205 4F Arches
PB5X5	5 1/4"	1"	FLT109
PB6X6	5 5/8"	1 1/8"	FLT159 MLD706 6F Arches

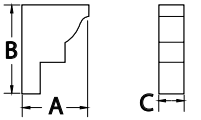

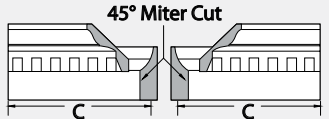
# Crown Dentil E-Vent™ System

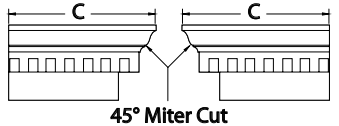
404 System

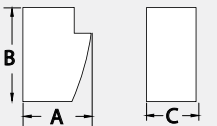



Part Number	Projection (A)	Height (B)	Width / Length (C)
 EV404 Moulding Matches MLD404	4 7/16"	6 3/16"	144" 
 EV404B Joint Block / End Cap	4 11/16"	6 5/16"	1 3/4" 
 EV404MI Inside Corner Ships in 2 pieces	4 7/16"	6 3/16"	14"-18" ^ 
 EV404MO Outside Corner Ships in 2 pieces	4 7/16"	6 3/16"	14"-18" ^ 
 EVFB Filler Block Fits all E-Vent Systems	1 3/8"	1 15/16"	1" 

^ Length may vary to ensure repeatable design.

Parts may be required to ship LTL (less than truckload) based on size and overall dimensions.

# Combination Crown E-Vent™ System





570 System

Part Number	Projection (A)	Height (B)	Width / Length (C)
 EV570 Moulding Matches MLD570	7 7/16"	9 5/16"	144"
 EV570B Joint Block / End Cap	7 1/2"	9 7/16"	1 3/4"
 EV570MI Inside Corner Ships in 2 pieces	7 7/16"	9 5/16"	17"
 EV570MO Outside Corner Ships in 2 pieces	7 7/16"	9 5/16"	22"
 EVFB Filler Block Fits all E-Vent Systems	1 3/8"	1 15/16"	1"



# Massive Crown E-Vent™ System

580 System

Part Number	Projection (A)	Height (B)	Width / Length (C)
 EV580 Moulding Matches MLD580	9 1/32"	14 3/4"	144"
 EV580B Joint Block / End Cap	9 1/4"	14 11/16"	1 3/4"
 EV580MI Inside Corner Ships in 2 pieces	9 1/32"	14 3/4"	21 31/32"
 EV580MO Outside Corner Ships in 2 pieces	9 1/32"	14 3/4"	22 1/32"
 EVFB Filler Block Fits all E-Vent Systems	1 3/8"	1 15/16"	1"

Parts may be required to ship LTL (less than truckload) based on size and overall dimensions.



# Decorative Millwork



Brackets .....	122
Knee Braces .....	140
Dentil Blocks .....	141
Woodgrain Rafter Tails .....	146
Woodgrain Brackets .....	148
Woodgrain Knee Braces.....	151
Woodgrain Corbels.....	152
Gable Pediments .....	158
Trellis System .....	160
Porch Spandrels.....	162
Decorative Panels .....	162
Fishscale Panel .....	163
Tile Vents .....	163
Fixture Mounts .....	163
Spires .....	164
Finials .....	165
Ceiling Medallions .....	166
Smooth Beam .....	167
Woodgrain Beam Mantels .....	168
Woodgrain Beams .....	169

## Discover unlimited possibilities.

Our collection of architecturally correct and historically accurate Decorative Millwork – including Brackets, Corbels, Rafter Tails, Beams, Dentil Block, and other products – adds a refined look to both interior and exterior applications.

**Product Shown:**  
Hand Hewn Beam – BMH8X10X192ELM  
Beam Straps – BMSTRPS8X10





# Decorative Millwork

## How to Use This Section

The products in this section of the catalog are organized by product type. You can find a variety of products to match the aesthetics of almost any application conveniently grouped together. Where applicable, groupings of Brackets, Corbels, Rafter Tails, Beams, Dentil Blocks and other products are further sorted by height, from smallest to largest.

## How to Order

### Decorative Millwork Accessories

Some Decorative Millwork products have accessories available or are an accessory to another product. All Decorative Millwork accessories are unattached and must be ordered separately.

### Remember to Order Adhesive

A urethane-based adhesive **must** be used on all joint surfaces. See page 252 to order Loctite® PL Premium® Adhesive.\*













\*Loctite® PL Premium® is owned by Henkel IP & Holding GmbH.



# Smooth Brackets

Flat





Part Number	Projection (A)	Height (B)	Overall Width (C)
 BKT9X11	9"	11"	3 1/2"
 BKT12X12X4	12"	12"	3 1/2"
 BKT18X18X4	18"	18"	3 1/2"
 BKT16X16	15 7/8"	15 7/8"	2"
 BKT10X16X4	9 7/8"	16"	4 1/2"
 BKT12X16	11 1/2"	16"	3"
 BKT14X16X4	14"	16"	4 1/2"
 BKT17X17	16 1/2"	16 1/2"	3 1/2"
 BKT16X18X3	16"	18"	3 1/2"
 BKT11X20	11"	20"	3 1/8"

Note: Listed in order by height.



# Smooth Brackets



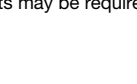







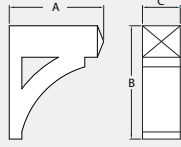

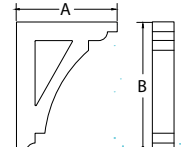

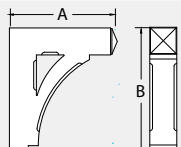

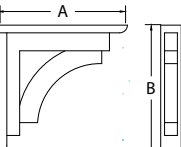

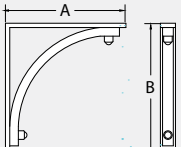
Flat

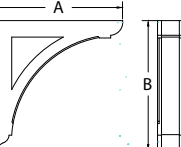
Part Number	Projection (A)	Height (B)	Overall Width (C)
 BKT12X24X3	12"	24"	3 1/2"
 BKT18X24X4	18"	24"	3 1/2"
 BKT18X30X4	18"	30"	3 1/2"
 BKT25X27	25"	27 1/2"	3 1/2"
 BKT36X36X4	36"	36"	4"
 BKT36X36X6	36"	36"	6"
BKT20X30X6	20"	30"	5 1/2"
BKT32X32	32"	32"	6"
BKT40X40	40"	40"	6"

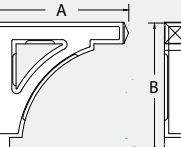
Parts may be required to ship LTL (less than truckload) based on size and overall dimensions.

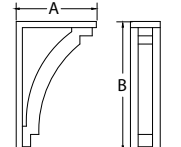
# Smooth Brackets

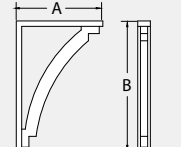
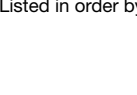
Cove / Arch

	Part Number	Projection (A)	Height (B)	Overall Width (C)	
	BKT15X18X6	15"	18"	6"	
	BKT19X24X4	18 5/8"	24"	4"	
	BKT19X36X4	19"	36"	4"	
	BKT20X24X5	20"	24"	5"	
	BKT25X25	25"	25"	4"	
	BKT28X30	28"	30"	3 1/2"	
	BKT30X30	30"	30"	6"	
	BKT36X36	36 1/8"	36 1/8"	6"	
	BKT31X30X5	31"	30"	5"	
	BKT19X31	19 1/2"	31 1/2"	7 1/4"	
	BKT24X36	24"	36"	3 1/2"	

Note: Listed in order by height.

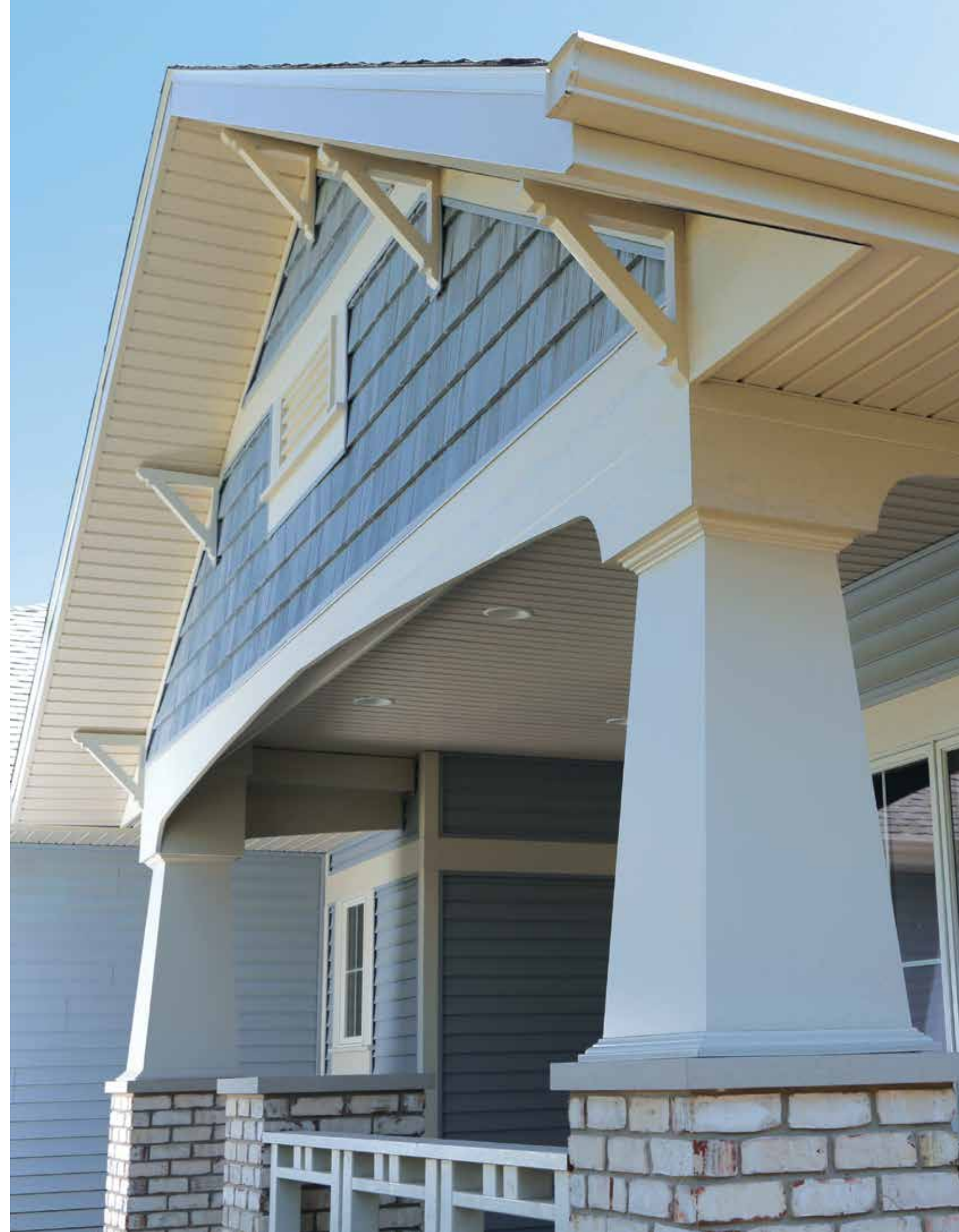









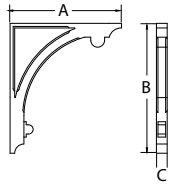

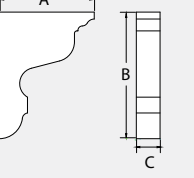

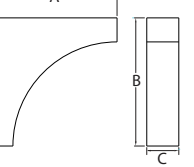
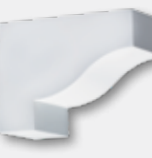
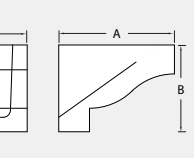

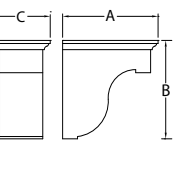

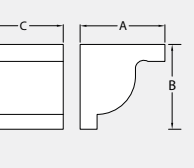
# Smooth Brackets

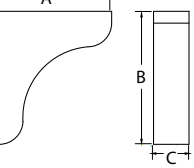

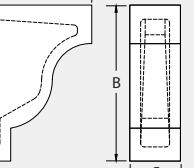







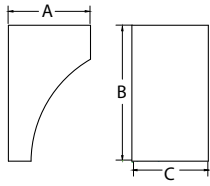

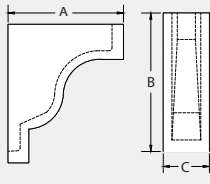

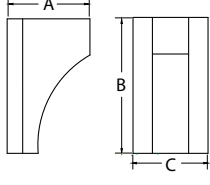
Cove / Arch

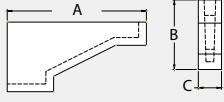
	Part Number	Projection (A)	Height (B)	Overall Width (C)	
	BKT36X42	36 1/4"	42 1/4"	3 1/2"	
	BKT6X8	6"	8"	1 1/2"	
	BKT8X8	8"	8"	2"	
	BKT8X6	8"	6"	4"	
	BKT8X8X4	8"	8"	4 7/8"	
	BKT10X10X9	10"	10"	9 1/8"	
	BKT10X11	10 1/2"	11 1/4"	3"	
	BKT7X11X3	7"	11"	3 1/2"	

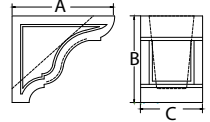
Parts may be required to ship LTL (less than truckload) based on size and overall dimensions.

# Smooth Brackets

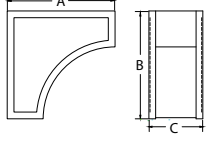

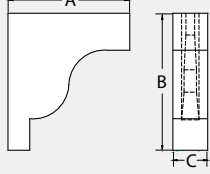



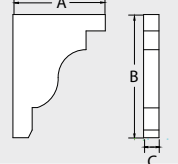

Cove / Arch

	Part Number	Projection (A)	Height (B)	Overall Width (C)	
	BKT7X12X4	7 1/4"	12"	4"	
	BKT10X12X4	10"	12"	4"	
	BKT8X13	8"	13"	7 1/4"	
	BKT18X9X3	18"	9"	3"	
	BKT12X10 Recessed	12"	10 1/8"	7 1/4"	
	BKT18X10 Recessed	18"	10 1/8"	7 1/4"	
	BKT24X24X12 Recessed	24"	24"	12"	
	BKT14X16	14"	15 3/4"	4"	

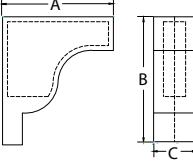

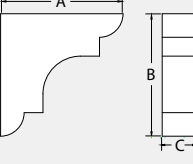
# Smooth Brackets

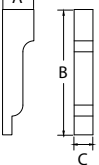
Cove / Arch

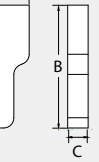
	Part Number	Projection (A)	Height (B)	Overall Width (C)	
	BKT18X24X3	18"	24"	3"	
	BKT22X26	22 1/2"	26"	8 1/2"	
	BKT13X13X3	13"	13"	3 1/2"	
	BKT5X20	5"	20"	3"	
	BKT6X24	6"	24"	4"	

Parts may be required to ship LTL (less than truckload) based on size and overall dimensions.



# Smooth Brackets

Decorative

	Part Number	Projection (A)	Height (B)	Overall Width (C)	
	BKT5X8X6	7 7/8"	5"	5 3/4"	
	BKT9X13	9"	13"	3"	
	BKT11X15	11"	15"	3"	
	BKT5X10	5 1/4"	10"	4"	
	BKT8X15	7 7/8"	14 7/8"	8 1/4"	
	BKT11X16	10 1/2"	16 1/4"	4 3/8"	
	BKT4X18X4	4"	18"	4"	
	BKT6X24X6	6"	24"	6"	

Parts may be required to ship LTL (less than truckload) based on size and overall dimensions.











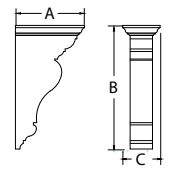

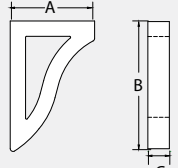

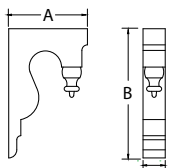

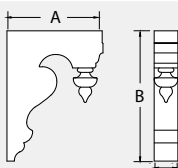

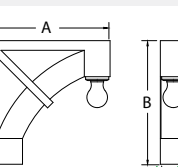

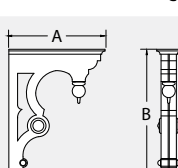
# Smooth Brackets

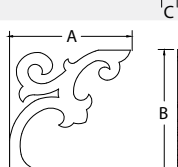
Decorative

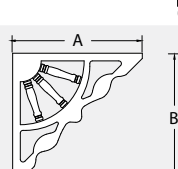









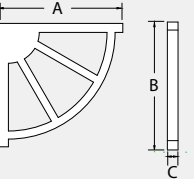

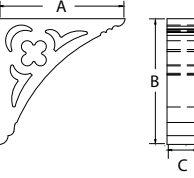

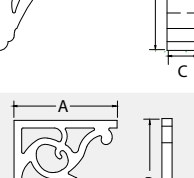

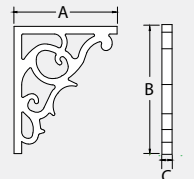

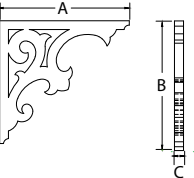
	Part Number	Projection (A)	Height (B)	Overall Width (C)	
	BKT15X28	15 3/8"	27 1/2"	8 3/8"	
	BKT11X17	11"	17"	2 7/8"	
	BKT10X16	9 3/4"	16"	2 3/4"	
	BKT12X17	12 1/8"	16 1/2"	3"	
	BKT24X24X5	24"	24"	5"	
	BKT22X30	22"	30"	5 1/2"	
	BKT12X12	12 1/4"	11 1/2"	1 1/8"	
	BKT12X12GP	12"	12"	1"	

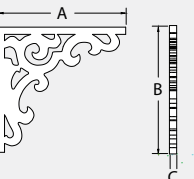
Parts may be required to ship LTL (less than truckload) based on size and overall dimensions.

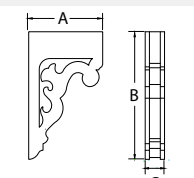

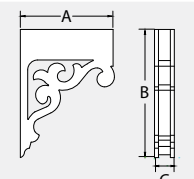
# Smooth Brackets

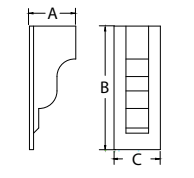
Decorative

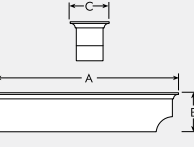
	Part Number	Projection (A)	Height (B)	Overall Width (C)	
	BKT12X12WW	12"	12"	1"	
	BKT12X12X3	12"	12"	3"	
	BKT22X21	21 3/4"	21 1/2"	3"	
	BKT10X12	10 1/8"	12 1/2"	1"	
	BKT14X15	14"	14 3/4"	1"	
	BKT19X20	19 1/2"	20"	1 1/8"	
	BKT12X21X3	12 1/4"	21 1/8"	3 1/4"	
	BKT16X23X3	16 3/8"	22 3/4"	3 1/2"	
	BKT11X30	11 1/4"	30"	11 1/4"	
	BKT5X4	20 1/2"	4 3/8"	4 3/8"	

Parts may be required to ship LTL (less than truckload) based on size and overall dimensions.











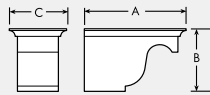

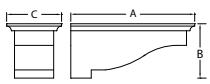

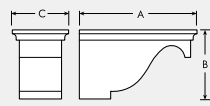
## Smooth Brackets

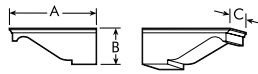
Decorative

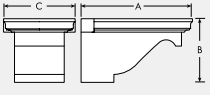
	Part Number	Projection (A)	Height (B)	Overall Width (C)	
	BKT5X5X9	8 3/4"	5 3/8"	4 7/8"	
	BKT13X6	13 1/4"	5 3/4"	5 7/8"	
	BKT7X6X12	11 1/2"	6 3/4"	5 1/2"	
	BKT8X7X18	18"	7 3/8"	7"	
	BKT8X9X14	14"	8"	9"	

Parts may be required to ship LTL (less than truckload) based on size and overall dimensions.







BKT10X14 is used with F100 to build up Bracket detail in photo.









## Smooth Brackets

Ornate

Part Number	Projection (A)	Height (B)	Overall Width (C)
 BKT11X20X8	11"	20 1/2"	8"
 BKT23X26	22 1/2"	26"	8 1/2"
 BKT18X35	17 1/2"	35"	11"

## Smooth Brackets



Ornate

Part Number	Projection (A)	Height (B)	Overall Width (C)
 BKT24X12	23 1/2"	11 1/2"	9 1/4"
 BKT10X14	9 3/4"	14 1/2"	3 3/4"
 BKT11X16X6	11"	16 1/4"	6"
 BKT16X9	9 1/4"	15 7/8"	3 5/8"
 BKT7X16	7 1/2"	16 1/4"	5 1/2"
 BKT8X17	8 1/4"	16 5/8"	6 1/4"
 BKT7X18	6 3/4"	18 1/4"	7 3/4"
 BKT11X20X6	11"	20"	6 1/2"
 BKT14X26	14 1/2"	26"	6 1/2"

Parts may be required to ship LTL (less than truckload) based on size and overall dimensions.





# Smooth Knee Braces

Flat

Part Number	Projection (A)	Height (B)	Overall Width (C)
 BKT11X12X3	11 1/4"	12"	3 1/2"
 BKT13X15	12 1/2"	14 5/8"	5"
 BKT14X14	13 1/4"	13 1/4"	3 1/2"
 BKT30X30X8	30"	30"	6 7/8"









# Smooth Knee Braces

Decorative

Part Number	Projection (A)	Height (B)	Overall Width (C)
 BKT15X15	15"	15"	2 1/2"
 BKT22X22	22"	22"	2 3/4"
 BKT26X28	26"	28"	2 1/2"
 BKT8X29X4	8 1/4"	29"	4"

# Smooth Dentil Blocks

Flat

Part Number	Projection (A)	Height (B)	Overall Width (C)
 DTLB3X3X3	3 1/2"	3 1/2"	3 1/2"
 DTLB3.5X3.5X7	7 3/8"	3 1/2"	3 1/2"
 DTLB4X6X9	8 3/4"	4 1/4"	6"
 DTLB5X6X6	6"	5"	6"
 DTLB5X6X18	17 5/8"	5"	6"
 DTLB5X6X8	8 1/2"	5"	6"
 F100^	10 3/8"	5 1/2"	5"
 DTLB5X5X3	5 1/2"	5 1/2"	3 1/2"

^ See accessory block BKT10X14 on page 139.



Parts may be required to ship LTL (less than truckload) based on size and overall dimensions.











## Smooth Dentil Blocks

Decorative

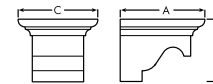
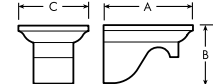
	Part Number	Projection (A)	Height (B)	Overall Width (C)	
	DTLB4X5X8	7 3/4"	3 3/8"	5"	
	DTLB5X6X10	9 1/2"	4 3/4"	5 7/8"	
	DTLB6X9X7	6 1/2"	5 1/2"	8 3/4"	

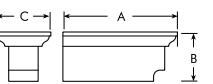
## Smooth Dentil Blocks

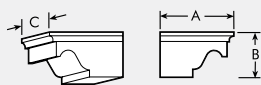

Decorative

	Part Number	Projection (A)	Height (B)	Overall Width (C)	
	DTLB4X6X6	6 1/4"	4 1/2"	5 3/4"	
	DTLB6X6X9	9 3/8"	5 3/4"	5 1/2"	
	DTLB9X8X8	9"	8 1/8"	8 1/8"	
	DTLB6X7X9	9 1/4"	6"	7 1/4"	
	DTLB3X5X6	5 3/4"	3 1/8"	4 1/2"	
	DTLB4X4X9	9"	3 7/8"	4 3/8"	
	DTLB4X4X7	7 1/4"	4 3/8"	5"	
	DTLB5X8	5 7/16"	8 1/4"	4 13/16"	
	DTLB9X11X16	16"	9 1/4"	11 1/4"	

Parts may be required to ship LTL (less than truckload) based on size and overall dimensions.

# Smooth Dentil Blocks

Assorted

	Part Number	Projection (A)	Height (B)	Overall Width (C)	
	DTLB4X6X7	7 1/8"	4"	6"	
	DTLB5X6X11	10 3/4"	5 1/4"	6"	
	DTLB5X4X7	6 7/8"	5 3/8"	4 3/8"	
	DTLB6X6X8	8"	5 3/8"	5 1/2"	
	DTLB5X8X10	10"	5 3/8"	7 7/8"	
	DTLB6X6X9.25	9 1/4"	6"	6"	
	DTLB6X4X6	5 1/2"	6 1/8"	4 3/4"	
	DTLB6X6X5	5 1/2"	6 1/4"	4 3/4"	
	DTLB6X5X7	6 3/4"	6 5/16"	5"	



# Smooth Dentil Blocks

Assorted

	Part Number	Projection (A)	Height (B)	Overall Width (C)		
	DTLB8X6X6	5 3/16"	8 1/8"	5 1/2"		
	DTLB3X3X4	4 1/2"	3 3/4"	3 3/4"		
	DTLB4X5X7	7 3/4"	4 1/4"	5 1/8"		
	DTLB4X4X4	4"	4"	4"		
	DTLB3.5X5.5X5.5	5 1/2"	3 1/2"	5 1/2"		
	DTLB6X4X6R12	5 1/2"	11"	4 3/4"	12 / 12	
	DTLB6X4X6L12	5 1/2"	10 15/16"	4 3/4"	12 / 12	

Parts may be required to ship LTL (less than truckload) based on size and overall dimensions.



**NEW**

## How to Order

- 1 Select profile design.
- 2 Select size.
- 3 Optional: Select pitch angle needed.
- 4 Select pack quantity.\*

- New Rafter Tails are available in five profile designs: Straight, Cove, Slant, Bullnose and Scroll.
- Available in heights measuring 5 1/2" (6 nominal) and 7 1/2" (8 nominal).
- 6 Projections: 12", 18", 24", 30", 36", 42".
- Optional back cut pitch angles: 4/12, 6/12, 8/12, 10/12 and 12/12.
- Quantities: 4 Pack, 10 Pack.

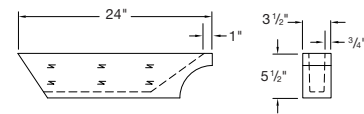

Part Number Logic (Pitch required):

**BMRTCV4X6X24RSP8-10PK**



\*Longer Rafter Tails are only available in pack quantities of 4.

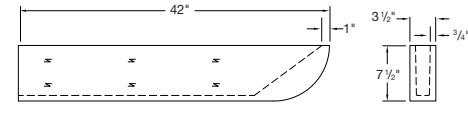

Part Number Logic (No Pitch needed):

**BMRTBL4X8X42RS-4PK**



\*Longer Rafter Tails are only available in pack quantities of 4.

## Rafter Tails

Rough Sawn Woodgrain



Straight Profile	Cove Profile	Slant Profile	Bullnose Profile	Scroll Profile
BMRTST4X6X12RS	BMRTCV4X6X12RS	BMRTSL4X6X12RS	BMRTBL4X6X12RS	BMRTSC4X6X12RS
BMRTST4X6X18RS	BMRTCV4X6X18RS	BMRTSL4X6X18RS	BMRTBL4X6X18RS	BMRTSC4X6X18RS
BMRTST4X6X24RS	BMRTCV4X6X24RS	BMRTSL4X6X24RS	BMRTBL4X6X24RS	BMRTSC4X6X24RS
BMRTST4X6X30RS*	BMRTCV4X6X30RS*	BMRTSL4X6X30RS*	BMRTBL4X6X30RS*	BMRTSC4X6X30RS*
BMRTST4X6X36RS*	BMRTCV4X6X36RS*	BMRTSL4X6X36RS*	BMRTBL4X6X36RS*	BMRTSC4X6X36RS*
BMRTST4X6X42RS*	BMRTCV4X6X42RS*	BMRTSL4X6X42RS*	BMRTBL4X6X42RS*	BMRTSC4X6X42RS*
BMRTST4X8X18RS	BMRTCV4X8X18RS	BMRTSL4X8X18RS	BMRTBL4X8X18RS	BMRTSC4X8X18RS
BMRTST4X8X24RS	BMRTCV4X8X24RS	BMRTSL4X8X24RS	BMRTBL4X8X24RS	BMRTSC4X8X24RS
BMRTST4X8X30RS*	BMRTCV4X8X30RS*	BMRTSL4X8X30RS*	BMRTBL4X8X30RS*	BMRTSC4X8X30RS*
BMRTST4X8X36RS*	BMRTCV4X8X36RS*	BMRTSL4X8X36RS*	BMRTBL4X8X36RS*	BMRTSC4X8X36RS*
BMRTST4X8X42RS*	BMRTCV4X8X42RS*	BMRTSL4X8X42RS*	BMRTBL4X8X42RS*	BMRTSC4X8X42RS*

Note: All parts have open cavity. \*Longer rafter tails are only available in pack quantities of 4.

Optional Pitch:

Pack Quantity:

4/12 = P4    6/12 = P6    8/12 = P8    10/12 = P10    12/12 = P12

-4PK    -10PK



## Rafter Tails

Standard Woodgrain

Part Number	Length (A)	Height (B)	Overall Width (C)
BMRTS6X4X24S*	24"	3 1/4"	5 1/4"
BMRTS6X6X12S*	12"	5 1/4"	5 1/4"
BMRTS8X4X24S*	24"	7 1/4"	3 1/4"
BMRT4X8X42S*	42"	8"	4"
BMCRT25X12X6S*	25"	12"	6"

\*Product has open cavity.

## Rafter Tails

Standard Woodgrain Double-Ended

Part Number	Length (A)	Height (B)	Overall Width (C)
BMRT4X8X42S*	24"	8"	4"









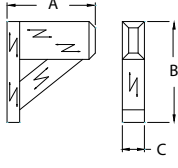

\*Product has open cavity.

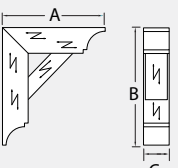
Parts may be required to ship LTL (less than truckload) based on size and overall dimensions.

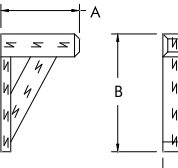

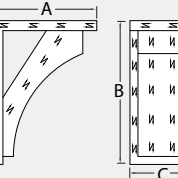
# Brackets

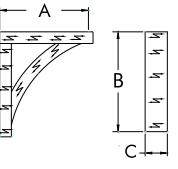
Standard Woodgrain

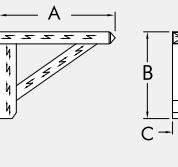
	Part Number	Projection (A)	Height (B)	Overall Width (C)	
	BKT14X16X3.5S	14"	16"	3 1/2"	
	BKT14X16X6S	14"	16"	5 1/2"	
	BKT22X24X4S-1	22"	24"	3 1/2"	
	BKT22X24X6S	22"	24"	5 1/2"	
	BKT26X24X4S	26"	24"	3 1/2"	
	BKT26X24X6S	26"	24"	5 1/2"	
	BKT12X18X3X1S	12"	18"	3 1/2"	
	BKT18X18X3X1S	18"	18"	3 1/2"	
	BKT13X18X8S	13"	18"	8"	
	BKT16X18X4S	16"	18"	4"	
	BKT24X18X4S	24"	18"	4"	







Parts may be required to ship LTL (less than truckload) based on size and overall dimensions.



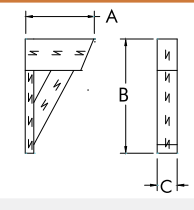

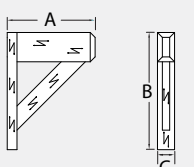
# Brackets

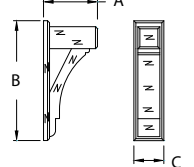

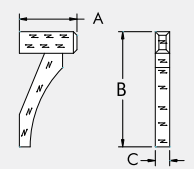



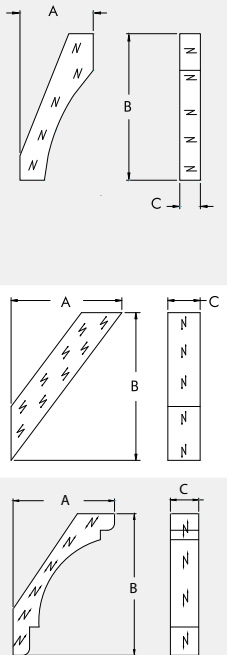

Standard Woodgrain

	Part Number	Projection (A)	Height (B)	Overall Width (C)	
	BKT12X20X3S	12"	20"	3 1/2"	
	BKT18X24X3X2S	18"	24"	3 1/2"	
	BKT14X30X7.5S	13 1/2"	30"	7 1/2"	
	BKT22X30X8S	21 1/2"	30"	7 1/2"	
	BKT16X32X4S	16"	32"	4"	

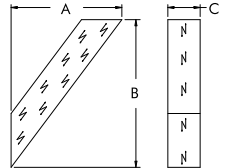

# Knee Braces

Standard Woodgrain

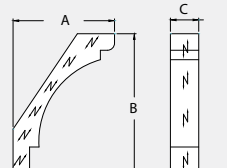
	Part Number	Projection (A)	Height (B)	Overall Width (C)	
	BKT12X24X3S	12"	24"	3 3/8"	
	BKTCV18X24X4S	18"	24"	3 1/4"	
	BKTCV18X24X6S	18"	24"	5 1/4"	
	BKTCV21X30X4S	21"	30"	3 1/4"	
	BKTCV21X30X6S	21"	30"	5 1/4"	
	BKTS18X24X6S	18"	24"	5 1/2"	
	BKT22X30X6S	21 1/2"	30"	6"	

Parts may be required to ship LTL (less than truckload) based on size and overall dimensions.



# Corbels - Cove

Standard Woodgrain

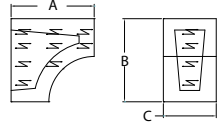
	Part Number	Projection (A)	Height (B)	Overall Width (C)	
	COR5X5X3S*	5 1/2"	5 1/2"	3 1/2"	
	COR5X5S*	5 1/2"	5 1/2"	5 1/2"	
	COR8X8X6S*	8"	8"	6"	
	COR11X11X5S*	11"	11"	5"	
	COR18X8X6S*	18"	8"	6"	
	CORCV18X6X6S*	18"	5 1/4"	5 1/4"	
	CORCV18X8X4S*	18"	7 1/4"	3 1/4"	
	CORCV18X8X6S*	18"	7 1/4"	5 1/4"	
	CORCV18X12X6S*	18"	11 1/4"	5 1/4"	
	COR24X8X6S*	24"	8"	6"	
	COR7X13X7S*	13"	7 1/4"	7 1/2"	

\*Product has open cavity.  
Parts may be required to ship LTL (less than truckload) based on size and overall dimensions.





# Corbels - Scroll

Standard Woodgrain





Part Number	Projection (A)	Height (B)	Overall Width (C)
 COROG24X6S*	24"	5 7/8"	5 5/8"
 COROG20X7S*	20"	7"	8 1/2"
 COROG15X7S*	14 1/2"	7 1/4"	6"
 COROGA15X7S*	14 1/2"	7 1/4"	6"
 COROGD15X7S*	14 1/2"	7 1/4"	6"
 COR7X11S	11 3/8"	7 3/8"	7"
 COROG8X12S*	11 3/8"	7 3/8"	7 3/8"

\*Product has open cavity.



# Corbels - Scroll

Standard Woodgrain

Part Number	Projection (A)	Height (B)	Overall Width (C)
 COR39X10X5.5S*	39 1/4"	9 1/8"	5 1/2"
 COR16X10X8S*	16"	10 1/2"	8"
 COR14X12X6S*	14"	12"	6"
 COR11X13X6S*	11"	13"	6"











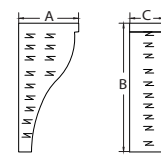

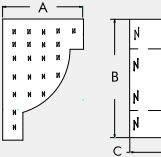

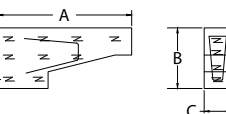
\*Product has open cavity.

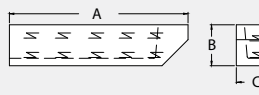
Parts may be required to ship LTL (less than truckload) based on size and overall dimensions.

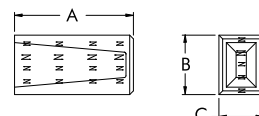

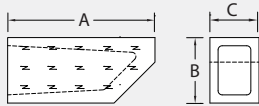
# Corbels - Assorted

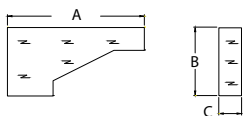
Standard Woodgrain

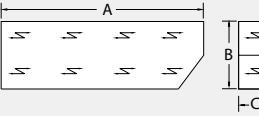
	Part Number	Projection (A)	Height (B)	Overall Width (C)	
	COR7X15X4S	7"	15"	4"	
	COR12X18X6S	12"	18"	6"	
	COR16X7X3S*	16"	7 1/4"	3 1/4"	
	COR24X5X5S*	24"	5 1/2"	5 1/2"	
	COR16X8S*	16"	8"	6"	
	COR18X8X6S*	18"	8"	6"	
	COR18X9X3S	18"	9"	3"	
	COR24X8X4S	24"	8"	4"	

\*Product has open cavity.

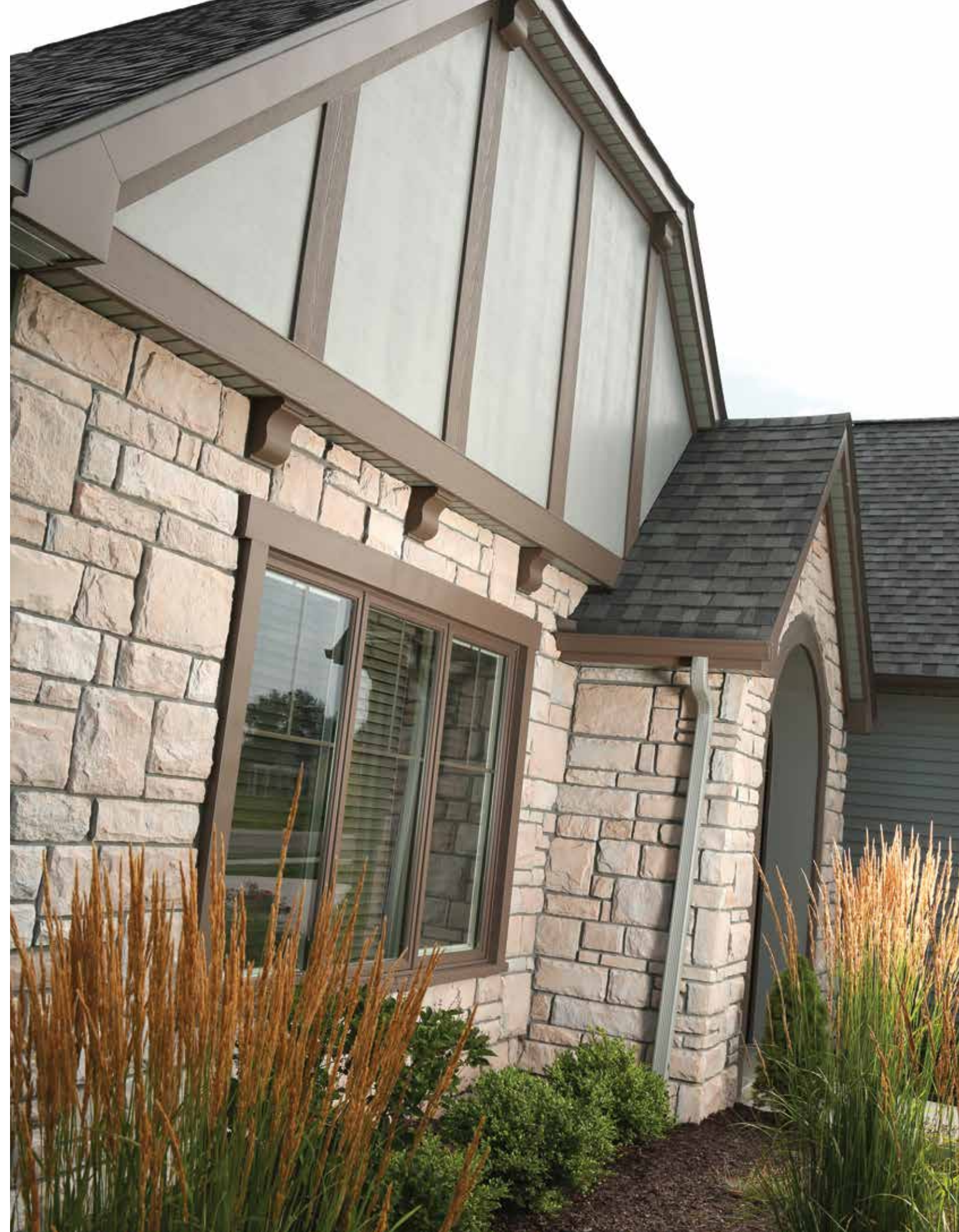





## Gable Pediments

Victorian Style

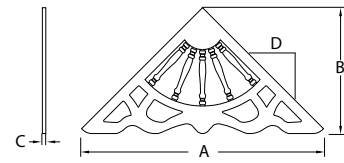

Part Number	Overall Width (A)	Overall Height (B)	Projection (C)	Pitch (D)
GP64X32	62"	32 1/4"	1"	12 / 12
GP80X33	80 1/4"	33 3/4"	1"	10 / 12
GP81X31	81 1/4"	31 1/4"	1"	9 / 12
GP88X29	86 3/8"	29 3/8"	1"	8 / 12
GP96X28	96"	28"	1"	7 / 12
GP107X22	107"	22"	1"	5 / 12
GP110X27	106 7/8"	27 3/8"	1"	6 / 12

## Gable Pediments

Arched Style

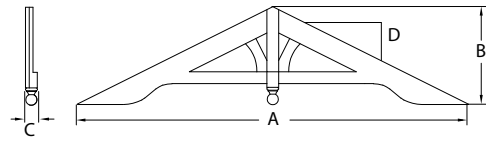

Part Number	Overall Width (A)	Overall Height (B)	Projection (C)	Pitch (D)
GPA70X35	70"	35"	3 1/4"	12 / 12
GPA81X34	80 1/2"	33 1/2"	3 1/4"	10 / 12
GPA86X32	85 1/4"	32 1/4"	3 1/4"	9 / 12
GPA87X29	86 7/8"	29"	3 1/4"	8 / 12
GPA95X28	95 1/4"	27 3/4"	3 1/4"	7 / 12
GPA104X26	103 1/2"	25 7/8"	3 1/4"	6 / 12

## Gable Pediments

Flat Style

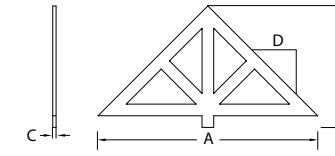
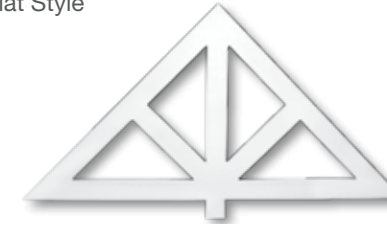

Part Number	Overall Width (A)	Overall Height (B)	Projection (C)	Pitch (D)
GPF66X33	66"	36 1/2"	1"	12 / 12

## Gable Pediment Kits

Stewart System

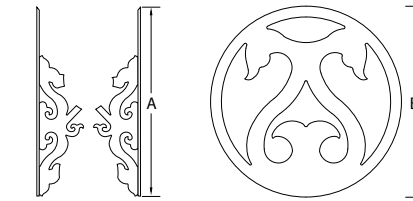

Part Number	Rake Length (A) (Each Side)	Pitch	Accessories
GPK401	39 1/4"	Adjustable from 5 / 12 to 14 / 12 pitch	GPK451
GPK801	77 1/2"	Adjustable from 5 / 12 to 14 / 12 pitch	GPK851

  

Part Number	Diameter (B)	Pitch	Accessories
GPK451	16"	—	GPK401
GPK851	32 1/8"	—	GPK801

Note: GPK401 and GPK801 kits include adhesive and screws.

## Gable Pediment Kits

Basic System

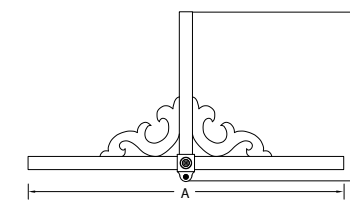
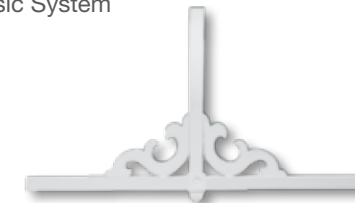

Part Number	Base Width (A)	Overall Height (B)	Thickness	Accessories
GPK100	96"	51 5/8"	1 1/4"	Adjustable from 6 / 12 to 12 / 12



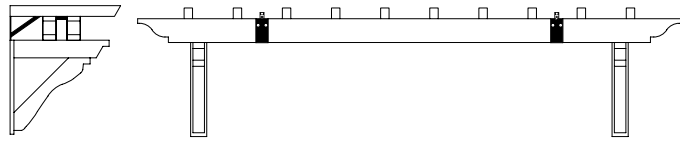

Note: Ships in 6 pieces; field trimming and assembly required. Installation hardware and instructions included. Parts may be required to ship LTL (less than truckload) based on size and overall dimensions.

# Smooth Trellis System



Trellis Kit Part Number & Contents	Overall Width (Installed)	Overall Height (Installed)	Projection (Installed)
<b>TRLS19003</b> Fits 16'-18' Garage Doors (2) BKT32X31X5, <i>Outlooker</i> (4) BMD4X8X144, <i>12' Beam</i> (18) FLTBA36X3X3, <i>Rafter Tail</i> (1) TRLS18989, <i>Hardware Kit</i>	21' 9" <i>Over 16' Door</i>	41 7/8"	36"
	23' 9" <i>Over 18' Door</i>		

<b>TRLS19004</b> Fits 8'-9' Garage Doors (2) BKT32X31X5, <i>Outlooker</i> (2) BMD4X8X48, <i>4' Beam</i> (2) BMD4X8X144, <i>12' Beam</i> (10) FLTBA36X3X3, <i>Rafter Tail</i> (1) TRLS18994, <i>Hardware Kit</i>	13' 9" <i>Over 8' Door</i>	41 7/8"	36"
	14' 9" <i>Over 9' Door</i>		

Individual Trellis Components	Part Number	Projection	Height	Overall Width
	BKT32X31X5 Outlooker	32 1/2"	30 5/8"	5 1/4"
	BMD4X8X48^ Beam	4 1/4"	7 3/4"	48"
Scrolled profile on one end only.	BMD4X8X144^ Beam	4 1/2"	7 3/4"	144"
	FLTBA36X3X3^ Lattice	36"	3 1/2"	2 3/4"
Angled on one end only.				
	TRLS18989 Hardware Kit for TRLS19003	<b>Kit Contains:</b> (3) Angle Bracket (3) U Bracket (1) HDW Pack (1) Installation Guide	—	—
	TRLS18994 Hardware Kit for TRLS19004	<b>Kit Contains:</b> (2) Angle Bracket (2) U Bracket (1) HDW Pack (1) Installation Guide	—	—

^ This product is not finished on all sides.  
HDW pack contains: lock washers, hex nuts and bolts.  
For installation instructions, visit [www.fypon.com](http://www.fypon.com).

# Woodgrain Trellis System

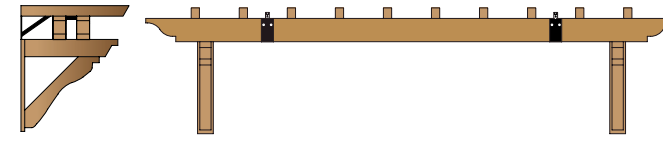

Trellis Kit Part Number & Contents	Overall Width (Installed)	Overall Height (Installed)	Projection (Installed)
<b>TRLS18987</b> Fits 16'-18' Garage Doors (2) BKT32X31X5S, <i>Outlooker</i> (4) BMD4X8X144S, <i>12' Beam</i> (18) FLTBA36X3X3S, <i>Rafter Tail</i> (1) TRLS18989, <i>Hardware Kit</i>	21' 9" <i>Over 16' Door</i>	41 7/8"	36"
	23' 9" <i>Over 18' Door</i>		

<b>TRLS18988</b> Fits 8'-9' Garage Doors (2) BKT32X31X5S, <i>Outlooker</i> (2) BMD4X8X48S, <i>4' Beam</i> (2) BMD4X8X144S, <i>12' Beam</i> (10) FLTBA36X3X3S, <i>Rafter Tail</i> (1) TRLS18994, <i>Hardware Kit</i>	13' 9" <i>Over 8' Door</i>	41 7/8"	36"
	14' 9" <i>Over 9' Door</i>		



Individual Trellis Components	Part Number	Projection	Height	Overall Width
	BKT32X31X5S Outlooker	32 1/2"	30 5/8"	5 1/4"
	BMD4X8X48S^ Beam	4 1/4"	7 3/4"	48"
Scrolled profile on one end only.	BMD4X8X144S^ Beam	4 1/4"	7 3/4"	144"
	FLTBA36X3X3S^ Lattice	36"	3 1/2"	2 3/4"
Angled on one end only.				
	TRLS18989 Hardware Kit for TRLS18987	<b>Kit Contains:</b> (3) Angle Bracket (3) U Bracket (1) HDW Pack (1) Installation Guide	—	—
	TRLS18994 Hardware Kit for TRLS18988	<b>Kit Contains:</b> (2) Angle Bracket (2) U Bracket (1) HDW Pack (1) Installation Guide	—	—

^ This product is not finished on all sides.  
HDW pack contains: lock washers, hex nuts and bolts.  
For installation instructions, visit [www.fypon.com](http://www.fypon.com).  
Parts may be required to ship LTL (less than truckload) based on size and overall dimensions.





## Porch Spandrels

Part Number	Length (A)	Height (B)	Projection (C)	Design Repeat (D)
 PRs48X8	48"	7 3/4"	1"	5 1/4"
 PRs96X8	97 1/2"	8 1/4"	2 7/8"	8 1/8"

## Decorative Panels

Part Number	Width / Height (A, B)	Projection (C)
 DP28X28SQX Square	28"	1 1/4"



Note: Panels are designed for decorative use only and cannot be used in a structural rail containment application.

## Fishscale Panel



Round Scales

Part Number	Length (A)	Overall Length (B)	Height (C)	Projection (D)
 FSR103X17	99 1/4"	102 1/8"	16 3/4"	3/4"

## Tile Vents



Part Number	Width (A)	Height (B)	Projection (C)
 CN6X6	6"	6"	6"
 TV20X20-3FR	20"	19 3/4"	3 1/2"

## Fixture Mounts

Part Number	Width (A)	Height (B)	Inside Width (C)	Inside Height (D)	Projection (E)
 FM8X12X2 Vertical	8"	12"	2 1/2"	4"	2"
 FMS8X8X2 Square	8"	8"	3 3/4"	2 3/4"	2"













# Spires

Part Number	Base Diameter (A)	Diameter (B)	Height (C)	Anchoring Pipe
 S4X21	3 1/2"	7"	21 1/4"	3/4" x 6"
 S6X32	4 1/4"	6"	32 1/4"	1 1/8" x 3"
 S8X56	8"	8"	56"	1 1/8" x 18"

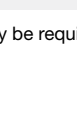

# Full-Round Finial

Part Number	Ball Diameter (A)	Height (B)	Base Diameter (C)
 B4X6	4"	5 1/2"	3 1/2"
 B5X7	5 1/4"	6 3/4"	4 3/8"
 B6X8	5 7/8"	7 3/4"	5 7/8"
 B6X9	7"	9"	5 7/8"
 B8X10	8"	10"	8 1/4"
 B10X13	10"	12 7/8"	8 1/2"
B12X16	12"	16"	12"
 B3X4 Pedestal Ball	3 1/8"	4 5/8"	3 1/4"
 B3X5 Post Ball	3 1/4"	5 1/4"	3 1/4"
 B7X9 Decorative Ball	6 1/4"	8 1/2"	6 1/2"
 AFR10 Acorn	4 7/8"	11 1/8"	4 1/2"
 PHFR5X11 Pineapple	5 5/8"	11"	4 3/4"
 PHFR6X14 Pineapple	7 1/8"	14"	6 1/8"

Parts may be required to ship LTL (less than truckload) based on size and overall dimensions.



# Ceiling Medallions

One-Piece

	Part Number	Diameter / Width	Projection	Center Opening Diameter
	CM15BM Beaumont	14 3/8"	2 1/4"	1"
	CM16FL Florentine	16"	1 1/8"	4 1/8"
	CM24RN Randolph	24 3/8"	1 1/2"	1"
	CM36NI Nicolas	35 3/4"	2"	2"
	CM67WT Whitney	67 1/2" Width 43 1/2" Height	1"	4 3/8"



# Smooth Beam

	Part Number	Overall Width (A)	Overall Height (B)	Length (C)	Inside Width	Inside Height
	BM4X5X192	6 5/8"	5"	16'	2"	4"

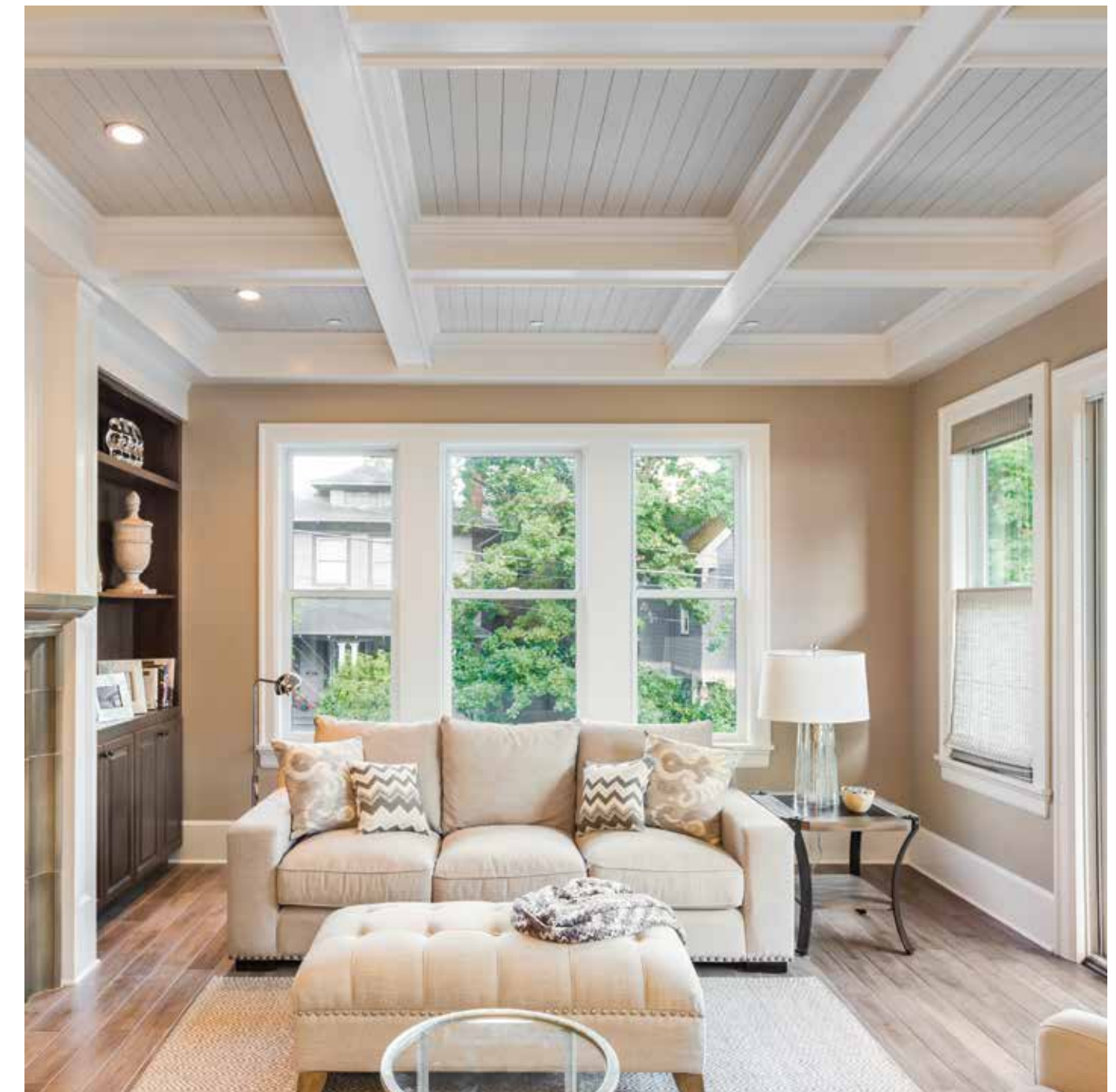

Parts may be required to ship LTL (less than truckload) based on size and overall dimensions.

# Ceiling Medallions

Two-Piece

	Part Number	Diameter / Width	Projection	Center Opening Diameter
	CM16FL2 Florentine	15 3/4"	1 1/8"	5 5/8"
	CM16JE2 Jefferson	15 1/2"	3/4"	5 3/4"



Decorative Millwork

Decorative Millwork



# Beam Mantel - Hand Hewn

Elm



**Sizes:**

- Available in 6" x 8" (projection x height) and 8" x 10" with lengths measuring 60" - 90", in 6" increments.



**Part Number**

- BMH6X8X60ELM-EC
- BMH6X8X66ELM-EC
- BMH6X8X72ELM-EC
- BMH6X8X78ELM-EC
- BMH6X8X84ELM-EC
- BMH6X8X90ELM-EC
- BMH8X10X60ELM-EC
- BMH8X10X66ELM-EC
- BMH8X10X72ELM-EC
- BMH8X10X78ELM-EC
- BMH8X10X84ELM-EC
- BMH8X10X90ELM-EC

# Beam - Hand Hewn

Elm



WXH Nominal Dimensions	Actual Dimensions*	Side Wall Thickness*	Inside Top Width*	Inside Bottom Width*
4" X 6"	3 1/2" X 5 1/2"	3/4"	2"	1 5/8"
6" X 8"	5 1/2" X 7 1/2"	3/4"	4"	3 1/2"
8" X 10"	7 1/2" X 9 1/2"	3/4"	6"	5 3/8"

Note: Beam inside dimensions are 1 1/4" wider to accommodate a standard 2" X 2", 2" X 4", 2" X 6", 2" X 8" blocking application.

\* +/- 1/4"



Note: Width and height are nominal, length is actual.

4" X 6" Part Number	6" X 8" Part Number	8" X 10" Part Number	Additional Sizes
BMH4X6X96ELM	BMH6X8X96ELM	BMH8X10X96ELM	Available in 24" increments, from 96" to 288".  See price pages for individual part numbers.
BMH4X6X144ELM	BMH6X8X144ELM	BMH8X10X144ELM	
BMH4X6X192ELM	BMH6X8X192ELM	BMH8X10X192ELM	
BMH4X6X240ELM	BMH6X8X240ELM	BMH8X10X240ELM	
BMH4X6X288ELM	BMH6X8X288ELM	BMH8X10X288ELM	



# Beam Mantel - Rough Sawn

Cedar



**Part Number**

- BMR6X8X60CDR-EC
- BMR6X8X66CDR-EC
- BMR6X8X72CDR-EC
- BMR6X8X78CDR-EC
- BMR6X8X84CDR-EC
- BMR6X8X90CDR-EC
- BMR8X10X60CDR-EC
- BMR8X10X66CDR-EC
- BMR8X10X72CDR-EC
- BMR8X10X78CDR-EC
- BMR8X10X84CDR-EC
- BMR8X10X90CDR-EC



Hand Hewn

Refer to Beam Freight Policy in Pricebook.



# Beam - Mesa

Redwood



WXH Nominal Dimensions	Actual Dimensions*	Side Wall Thickness*	Inside Top Width*	Inside Bottom Width*
4" X 6"	3 1/2" X 5 1/2"	3/4"	2"	1 5/8"
6" X 8"	5 1/2" X 7 1/2"	3/4"	4"	3 1/2"
8" X 10"	7 1/2" X 9 1/2"	3/4"	6"	5 3/8"
10" X 15"	9 1/8" X 14 3/4"	3/4"	7 5/8"	6 5/8"

Note: Beam inside dimensions are 1/4" wider to accommodate a standard 2" X 2", 2" X 4", 2" X 6", 2" X 8" blocking application.

\* +/- 1/4"



Note: Width and height are nominal, length is actual.

4" X 6" Part Number	6" X 8" Part Number	8" X 10" Part Number	10" X 15" Part Number	Additional Sizes
BMM4X6X96RDW	BMM6X8X96RDW	BMM8X10X96RDW	BMM10X15X234RDW**	Available in 24" increments, from 96" to 288".  See price pages for individual part numbers.
BMM4X6X144RDW	BMM6X8X144RDW	BMM8X10X144RDW		
BMM4X6X192RDW	BMM6X8X192RDW	BMM8X10X192RDW		
BMM4X6X240RDW	BMM6X8X240RDW	BMM8X10X240RDW		
BMM4X6X288RDW	BMM6X8X288RDW	BMM8X10X288RDW		

\*\*Only available in 234".

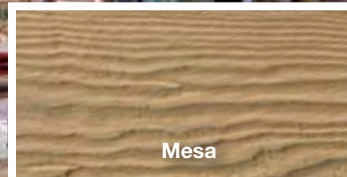

Mesa

Refer to Beam Freight Policy in Timber & Stone Pricebook.





# Beam - Rough Sawn

Cedar



WXH Nominal Dimensions	Actual Dimensions*	Side Wall Thickness*	Inside Top Width*	Inside Bottom Width*
4" X 6"	3 1/2" X 5 1/2"	3/4"	2"	1 5/8"
6" X 8"	5 1/2" X 7 1/2"	3/4"	4"	3 1/2"
8" X 10"	7 1/2" X 9 1/2"	3/4"	6"	5 3/8"

Note: Beam inside dimensions are 1 1/4" wider to accommodate a standard 2" X 2", 2" X 4", 2" X 6", 2" X 8" blocking application. \* +/- 1/4"

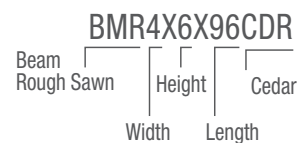

Note: Width and height are nominal, length is actual.

4" X 6" Part Number	6" X 8" Part Number	8" X 10" Part Number	Additional Sizes
BMR4X6X96CDR	BMR6X8X96CDR	BMR8X10X96CDR	Available in 24" increments, from 96" to 288".  See price pages for individual part numbers.
BMR4X6X144CDR	BMR6X8X144CDR	BMR8X10X144CDR	
BMR4X6X192CDR	BMR6X8X192CDR	BMR8X10X192CDR	
BMR4X6X240CDR	BMR6X8X240CDR	BMR8X10X240CDR	
BMR4X6X288CDR	BMR6X8X288CDR	BMR8X10X288CDR	



Refer to Beam Freight Policy in Pricebook.





# Beam - Tahoe

Cedar



WXH Nominal Dimensions	Actual Dimensions*	Side Wall Thickness*	Inside Top Width*	Inside Bottom Width*
4" X 6"	3 1/2" X 5 1/2"	3/4"	2"	1 5/8"
6" X 8"	5 1/2" X 7 1/2"	3/4"	4"	3 1/2"
8" X 10"	7 1/2" X 9 1/2"	3/4"	6"	5 3/8"

Note: Beam inside dimensions are 1 1/4" wider to accommodate a standard 2" X 2", 2" X 4", 2" X 6", 2" X 8" blocking application. \* +/- 1/4"

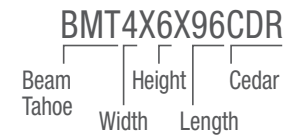

Note: Width and height are nominal, length is actual.

4" X 6" Part Number	6" X 8" Part Number	8" X 10" Part Number	Additional Sizes
BMT4X6X96CDR	BMT6X8X96CDR	BMT8X10X96CDR	Available in 24" increments, from 96" to 288".  See price pages for individual part numbers.
BMT4X6X144CDR	BMT6X8X144CDR	BMT8X10X144CDR	
BMT4X6X192CDR	BMT6X8X192CDR	BMT8X10X192CDR	
BMT4X6X240CDR	BMT6X8X240CDR	BMT8X10X240CDR	
BMT4X6X288CDR	BMT6X8X288CDR	BMT8X10X288CDR	



Refer to Beam Freight Policy in Pricebook.



## Beam Top

Mesa



Beam with Top shown.

Part Number	Nominal	Actual
BTM6X144*	6" x 8" x 144"	5 1/2" x 3/4" x 144"
BTM8X144*	8" x 10" x 144"	7 1/2" x 3/4" x 144"

\*Beam Top in Mesa woodgrain can be used with all beam styles.  
 Note: Product not available stained.



Beam with End Cap shown.

## Beam End Cap

Part Number	Nominal	Actual
BC10X15	10" x 15"	15 5/8" x 9 1/8" x 3/4"

Note: Product not available stained.

## Beam Plates

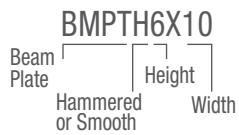

	Smooth	Hammered		Smooth	Hammered			
	Part Number	Part Number		Part Number	Part Number			
	BMPTS6X10 <sup>^</sup>	BMPTH6X10 <sup>^</sup>		BMPTS36X36 <sup>†</sup>	BMPTH36X36 <sup>†</sup>			
	BMPTS8X10 <sup>^</sup>	BMPTH8X10 <sup>^</sup>						
	BMPTS10X15 <sup>^</sup>	BMPTH10X15 <sup>^</sup>						
	BMPTS15X20 <sup>^</sup>	BMPTH15X20 <sup>^</sup>						

<sup>^</sup>Nuts and bolts molded into beam plates, sold in packages of 2, front and back plate  
 Note: Number of nuts and bolts molded into a beam plate is dependent on size of the plate.  
 Image shown is only representative of the appearance of the plate, either Smooth or Hammered.  
 Note: Sold in package quantities of 2. 2 front and 2 back plates, total of 4 parts per package.

<sup>†</sup>Beam plate can be cut to fit your specific project requirement.  
 Note: Nut and bolt heads are included (20 of each packaged separately).  
 Additional packs can be ordered separately (BMPLTHDWKT40 = 20 nuts and 20 bolts,  
 BMPLTHDWKT20 = 10 nuts and 10 bolts, BMPLTHDWKT10 = 5 nuts and 5 bolts).

## Beam Straps

	Smooth		Hammered		
	Part Number	Beam Size	Part Number	Beam Size	
	BMSTRPS4X6	4" X 6"		BMSTRPH4X6	4" X 6"
	BMSTRPS6X8	6" X 8"		BMSTRPH6X8	6" X 8"
	BMSTRPS8X10	8" X 10"		BMSTRPH8X10	8" X 10"
	BMSTRPS10X15	10" X 15" <sup>**</sup>		BMSTRPH10X15	10" X 15" <sup>**</sup>

<sup>\*\*</sup>Mesa only.  
 Note: Width of beam strap is 6" for all beam sizes.  
 Note: Beam straps sold 2 per package.  
 Parts may be required to ship LTL (less than truckload) based on size and overall dimensions.







Classic Woodgrain

## Beam - Classic

Smooth Cedar

Part Number	Overall Width	Overall Height	Length	Inside Width	Inside Height
 BM4X5X192S	6 5/8"	5"	16'	2 3/4"	4 1/4"

## Beam - Milled

Smooth Cedar

Part Number	Overall Width	Overall Height	Length	Inside Width	Inside Height
 BMCDR4X3X168S	3 1/2"	2 1/2"	14'	2"	1 3/4"
BMCDR8X6X168S	7 1/4"	5 3/4"	14'	5 3/4"	5"



Milled

Parts may be required to ship LTL (less than truckload) based on size and overall dimensions.



# Louvers & Gable Vents



Cathedral Louver .....	184
Eyebrow Louver.....	185
Peaked Louver .....	185
Vertical Louver .....	186
Horizontal Louver .....	189
Half-Round Louver .....	190
Round Louver .....	192
Oval Louver .....	194
Triangle Louver .....	196
Two-Piece Triangle Louver .....	197
Diamond Louver .....	197
Octagon Louver.....	197

## Historic style for any home.

Fypon offers a diverse assortment of decorative, non-venting and functional, venting Louvers to complement most architectural home styles. Decorative Louvers feature a solid, one-piece design that does not allow air to pass through. Functional Louvers are designed to provide additional ventilation, with angled slats and screening to help protect interiors from the elements.

**Product Shown:**  
Louver LV18X30-4F  
Bracket – BKT9X11  
Flat Trim – FLT110-16  
Column Wrap – PremiumSelect CWPM13X20X60TFT





# Louvers & Gable Vents

## How to Use This Section

The products in this section of the catalog are organized by Louver style followed by matching Trim. Where applicable, matching Keystones are referenced for each Louver and Trim piece.

## How to Order

### Functional Louvers\*

If you are ordering a Functional Louver, you should order a Louver that is approximately 2" larger than your rough opening on all sides. This will allow you to attach the Louver to the substrate through the brickmould edge.

### Louver Accessories

Keystones and Trim are available attached to standard products as fabricated items. Keystones and Trim can also be ordered as unattached accessories by listing the matching part number as a separate line item on your order.

### Remember to Order Adhesive

A urethane-based adhesive **must** be used on all joint surfaces. See page 252 to order Loctite® PL Premium® Adhesive.\*\*



## Louver Keystone Applications

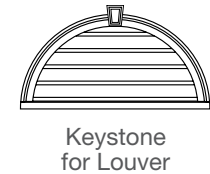
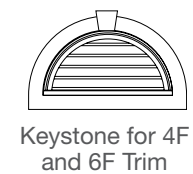
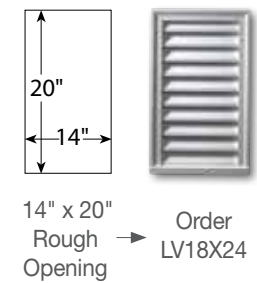

\* Always consult the local building code authority to determine suitability of products to meet specific project requirements. Images are representative of style, actual product will vary by size.  
\*\*Loctite® PL Premium® is owned by Henkel IP & Holding GmbH.

# Cathedral Louver

Brickmould Style



Cathedral Louver



4F Flat Trim

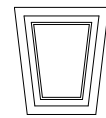

Keystone  
Page 53  
KWM180M

Louver Decorative Part Number	Width	Height	Louver Functional Part Number	Vent Area	Louver Trim
CLV12X24	12"	24"	FCLV12X24	10 Sq. In.	—
CLV14X22	14"	22"	FCLV14X22	14 Sq. In.	—
CLV16X36	16"	36"	FCLV16X36	21 Sq. In.	—
CLV18X24	18"	24"	FCLV18X24	20 Sq. In.	—
CLV18X30	18"	30"	FCLV18X30	36 Sq. In.	CLV18X30X4F
CLV18X54	18"	54"	FCLV18X54	50 Sq. In.	—
CLV22X31	22"	31 1/2"	FCLV22X31	41 Sq. In.	CLV22X31X4F
CLV24X48	24"	48"	FCLV24X48	73 Sq. In.	—
CLV28X43	28"	43"	FCLV28X43	76 Sq. In.	—
CLV36X48	36"	48"	FCLV36X48	102 Sq. In.	—

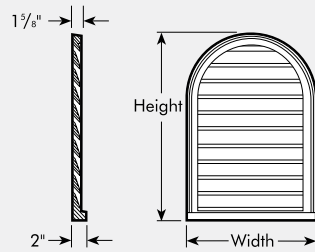

Flat Trim Part Number	Inside Width	Inside Height	Trim Width	Projection
CLV18X30X4F	18 1/4"	30 1/4"	3 1/2"	1"
CLV22X31X4F	22 1/4"	31 1/4"	3 1/2"	1"

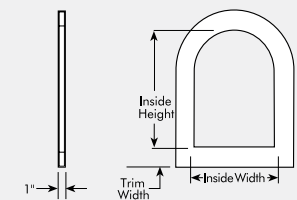

# Eyebrow Louver

Brickmould Style

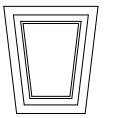
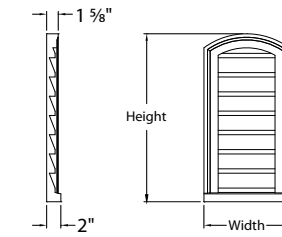

Keystone  
Page 53  
KWM180M

Decorative Part Number	Width	Overall Height	Shoulder Height	Radius	Functional Part Number	Vent Area
EBLV12X24	12"	24"	22"	10"	FEBLV12X24	13 Sq. In.
EBLV18X30	18"	30"	27 1/4"	16"	FEBLV18X30	30 Sq. In.
EBLV22X32	22"	32"	28 1/2"	20"	FEBLV22X32	38 Sq. In.

# Peaked Louver

Brickmould Style

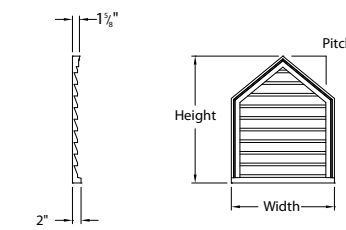

Decorative Part Number	Width	Height	Pitch	Functional Part Number	Vent Area
PLV18X24-8	18"	24"	8 / 12	FPLV18X24-8	20 Sq. In.
PLV18X36-10	18"	36"	10 / 12	FPLV18X36-10	35 Sq. In.
PLV24X30-10	24"	30"	10 / 12	FPLV24X30-10	37 Sq. In.
PLV24X36-10	24"	36"	10 / 12	FPLV24X36-10	48 Sq. In.
PLV24X36-12	24"	36"	12 / 12	FPLV24X36-12	47 Sq. In.

Parts may be required to ship LTL (less than truckload) based on size and overall dimensions.



# Vertical Louver

Brickmould Style

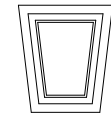
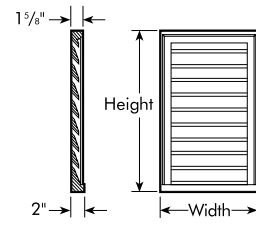

Keystone  
Page 53  
KWM180M

Decorative Part Number	Width	Height	Functional Part Number	Vent Area
LV8X15	8"	15"	FLV8X15	3 Sq. In.
LV8X24	8"	24"	FLV8X24	7 Sq. In.
LV8X30	8"	30"	FLV8X30	9 Sq. In.
LV12X18	12"	18"	FLV12X18	10 Sq. In.
LV12X24	12"	24"	FLV12X24	16 Sq. In.
LV12X30	12"	30"	FLV12X30	18 Sq. In.
LV12X36	12"	36"	FLV12X36	22 Sq. In.
LV12X40	12"	40"	FLV12X40	24 Sq. In.
LV14X27	14"	27"	FLV14X27	20 Sq. In.
LV14X30	14"	30"	FLV14X30	22 Sq. In.
LV14X32	14"	32"	FLV14X32	27 Sq. In.
LV16X24	16"	24"	FLV16X24	21 Sq. In.
LV16X36	16"	36"	FLV16X36	32 Sq. In.
LV18X24	18"	24"	FLV18X24	24 Sq. In.
LV18X30	18"	30"	FLV18X30	31 Sq. In.
LV18X36	18"	36"	FLV18X36	38 Sq. In.
LV18X42	18"	42"	FLV18X42	45 Sq. In.
LV20X28	20"	28"	FLV20X28	31 Sq. In.
LV24X24	24"	24"	FLV24X24	35 Sq. In.
LV24X30	24"	30"	FLV24X30	45 Sq. In.
LV24X36	24"	36"	FLV24X36	54 Sq. In.
LV24X48	24"	48"	FLV24X48	74 Sq. In.
LV30X42	30"	42"	FLV30X42	84 Sq. In.

Parts may be required to ship LTL (less than truckload) based on size and overall dimensions.





## Vertical Louver

with Flat Trim Attached<sup>^</sup>

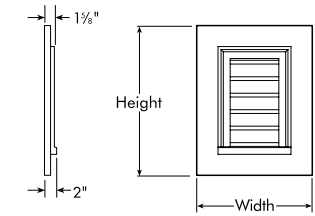

Decorative Part Number	Overall Width	Overall Height	Trim Width	Trim Projection
LV18X30-4F <sup>^</sup>	25"	37"	3 1/2"	1"

<sup>^</sup> Available as decorative only.

## Horizontal Louver

Brickmould Style

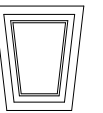
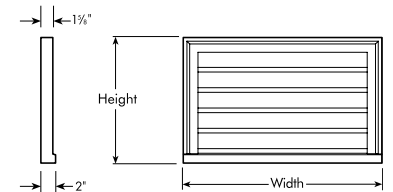

Keystone  
Page 53  
KWM180M

Decorative Part Number	Width	Height	Functional Part Number	Vent Area
LV27X17	27"	17"	FLV27X17	23 Sq. In.
LV32X16	32"	16"	FLV32X16	28 Sq. In.

## Vertical Louver

Brickmould Style with No Sill

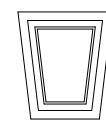
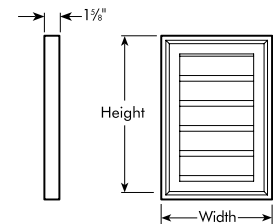

Keystone  
Page 53  
KWM180M

Decorative Part Number	Width	Height	Functional Part Number	Vent Area
LVNS18X24	18"	24"	FLVNS18X24	21 Sq. In.

## Vertical Louver

with 4F Flat Trim & 6" Crosshead

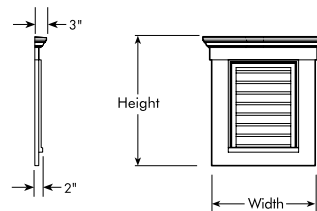

Decorative Part Number	Width	Overall Width	Height	Functional Part Number	Vent Area
LV18X24-4F6WCH	26 1/2"	31"	33 1/2"	FLV18X24-4F6WCH	24 Sq. In.







## Half-Round Louver

Brickmould Style



Half-Round Louver

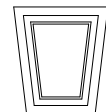

Keystone  
Page 53  
KWM180M

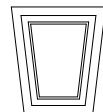

Keystone  
Page 53  
K4TF  
KP4TF

Decorative Part Number	Width	Height	Functional Part Number	Vent Area
HRLV24X12	24"	12"	FHRLV24X12	9 Sq. In.
HRLV28X14	28"	14"	FHRLV28X14	13 Sq. In.
HRLV32X16	32"	16"	FHRLV32X16	21 Sq. In.
HRLV36X18	36"	18"	FHRLV36X18	28 Sq. In.
HRLV40X20	40"	20"	FHRLV40X20	36 Sq. In.
HRLV42X21	42"	21"	FHRLV42X21	40 Sq. In.
HRLV48X24	48"	24"	FHRLV48X24	55 Sq. In.
HRLV60X30	60"	30"	FHRLV60X30	85 Sq. In.
HRLV72X36	72"	36"	FHRLV72X36	122 Sq. In.

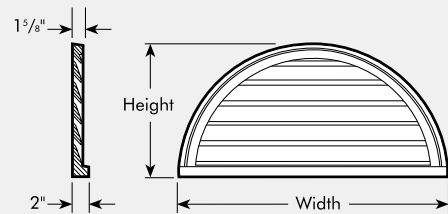

## Half-Round Louver

with Flat Trim Attached

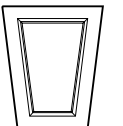
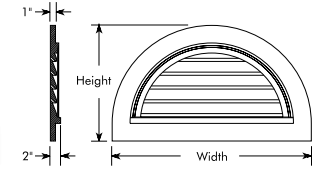

Keystone  
Page 53

K4TF, KP4TF, K6TF, KP6TF

Decorative Part Number	Overall Width	Overall Height	Trim Width	Trim Projection	Functional Part Number	Vent Area
HRLV36X18-4F	43"	25"	3 1/2"	1"	FHRLV36X18-4F	29 Sq. In.
HRLV36X18-6F	47"	29"	5 1/2"	1"	FHRLV36X18-6F	29 Sq. In.

## Half-Round Louver

with Decorative Trim & Keystone

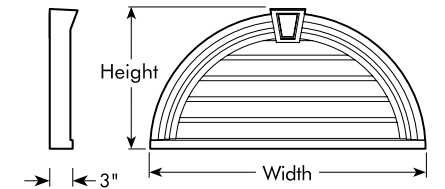

Decorative Part Number	Overall Width	Overall Height	Projection	Functional Part Number	Vent Area
HRLV36X18MTK	36"	18 1/2"	3"	FHRLV36X18MTK	24 Sq. In.

## Half-Round Louver

with Decorative Trim & Keystone

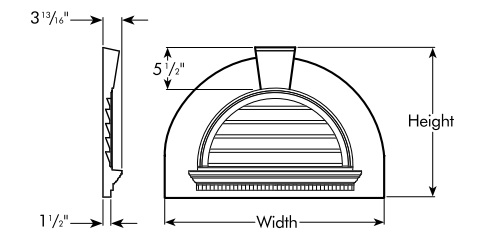

Decorative Part Number	Overall Width	Overall Height	Overall Projection	Trim Projection	Functional Part Number	Vent Area
HRLV29-6FKWD	41 5/8"	29"	3 3/4"	1 1/2"	FHRLV29-6FKWD	29 Sq. In.

Parts may be required to ship LTL (less than truckload) based on size and overall dimensions.

# Round Louver

Brickmould Style



Keystone  
Page 53  
KWM180M\*



4F Flat Trim

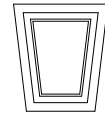

Keystone  
Page 53  
K4TF  
KP4TF

Decorative Part Number	Diameter	Functional Part Number	Vent Area	Louver Trim
RLV12 <sup>^</sup>	12"	FRLV12 <sup>^</sup>	7 Sq. In.	—
RLV16	16"	FRLV16	9 Sq. In.	—
RLV18	18"	FRLV18	12 Sq. In.	RLV18X4F
RLV22	22"	FRLV22	22 Sq. In.	—
RLV24	24"	FRLV24	27 Sq. In.	RLV24X4F
RLV28	28"	FRLV28	38 Sq. In.	RLV28X4F
RLV30	30"	FRLV30	46 Sq. In.	—
RLV36	36"	FRLV36	70 Sq. In.	CIR36X4F
RLV42	42"	FRLV42	99 Sq. In.	—
RLV48	48"	FRLV48	107 Sq. In.	—

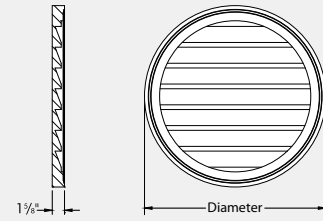

\* Product must be field trimmed to match RLV12 and FRLV12.  
<sup>^</sup> 1 5/16" projection on RLV12 and FRLV12.

Trim Part Number	Trim Width	Projection	Inside Diameter
RLV18X4F	3 1/2"	1"	18 1/4"
RLV24X4F	3 1/2"	1"	24 1/4"
RLV28X4F	3 1/2"	1"	28 1/4"

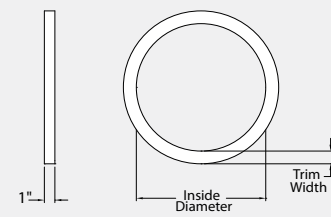

# Round Louver

with Flat Trim

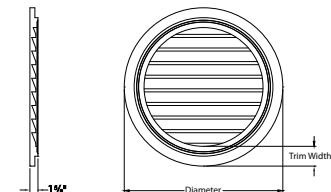

Decorative Part Number	Diameter	Trim Width	Trim Thickness	Functional Part Number	Vent Area
RLV32-2F	32"	2"	1 5/8"	FRLV32-2F	38 Sq. In.



# Round Louver

with Flat Trim & Flat Keystones

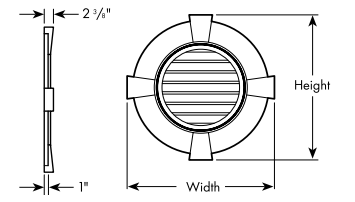

Decorative Part Number	Diameter	Overall Width / Height	Trim Width	Trim Thickness	Functional Part Number	Vent Area
RLV24-4FTK	31"	32 7/8"	3 1/2"	1"	FRLV24-4FTK	26 Sq. In.
RLV24-6TK	35"	38"	5 1/2"	1"	FRLV24-6TK	26 Sq. In.
RLV30-6TK	41"	44"	5 1/2"	1"	FRLV30-6TK	47 Sq. In.

# Round Louver

with Decorative Trim & Keystones

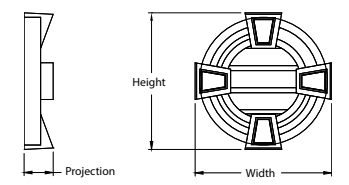

Decorative Part Number	Diameter	Overall Width / Height	Projection	Functional Part Number	Vent Area
RLV16MTK	16"	17 1/8"	3 5/8"	FRLV16MTK	4 Sq. In.
RLV18MTK	18"	19 1/8"	3 5/8"	FRLV18MTK	4 Sq. In.
RLV24MTK	23 7/8"	25"	3 5/8"	FRLV24MTK	19 Sq. In.
RLV30MTK	30"	31 1/8"	3 5/8"	FRLV30MTK	35 Sq. In.
RLV32MTK	31 5/8"	33 1/4"	4 1/8"	FRLV32MTK	26 Sq. In.
RLV40MTK	40"	41 1/4"	3 5/8"	FRLV40MTK	76 Sq. In.

Parts may be required to ship LTL (less than truckload) based on size and overall dimensions.



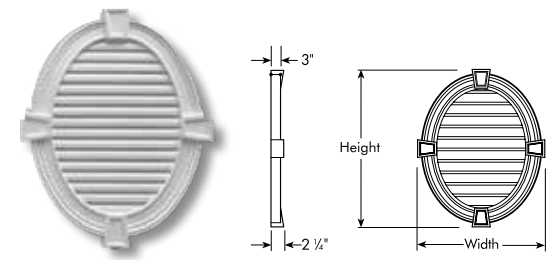

## Oval Louver – Vertical

with Decorative Trim & Keystones

Decorative Part Number	Overall Width	Overall Height	Projection	Functional Part Number	Vent Area
OVL28X35K215V	30"	37 1/2"	3"	FOVL28X35K215V	39 Sq. In.

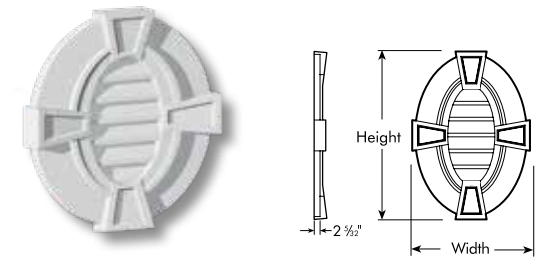

## Oval Louver – Vertical

with Flat Trim & Keystones

Decorative Part Number	Overall Width	Overall Height	Projection	Functional Part Number	Vent Area
OVLV20X29VTK	20"	29"	2 1/8"	FOVLV20X29VTK	9 Sq. In.

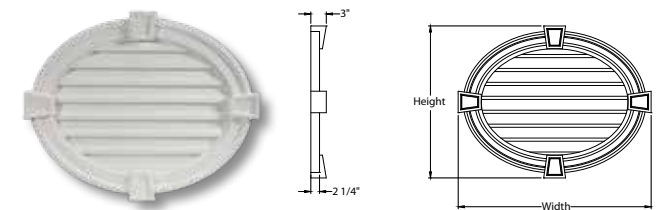

## Oval Louver – Horizontal

with Decorative Trim & Keystones

Decorative Part Number	Overall Width	Overall Height	Projection	Functional Part Number	Vent Area
OVL35X28K215	37 1/2"	30"	3"	FOVL35X28K215	41 Sq. In.

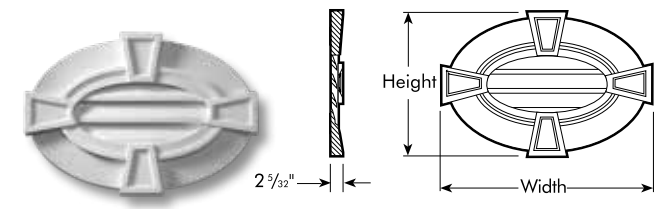

## Oval Louver – Horizontal

with Flat Trim & Keystones

Decorative Part Number	Overall Width	Overall Height	Projection	Vent Area
OVLV29X20TK	29"	20 5/8"	2 1/8"	7 Sq. In.

Parts may be required to ship LTL (less than truckload) based on size and overall dimensions.

## Round Louver

with Flat Trim & Keystones

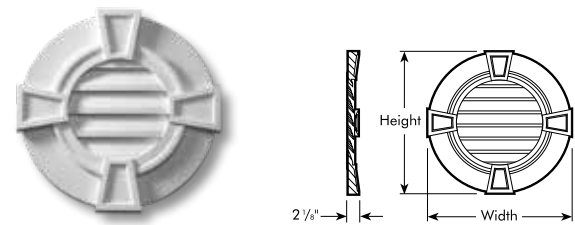

Decorative Part Number	Diameter	Width	Trim Width	Trim Thickness	Functional Part Number	Vent Area
RLV24TK	22 7/8"	24"	3 1/2"	1"	FRLV24TK	10 Sq. In.
RLV30TK	28 7/8"	30"	3 1/2"	1"	FRLV30TK	22 Sq. In.
RLV32TK	30 1/4"	31 1/2"	3 1/2"	1"	FRLV32TK	25 Sq. In.
RLV36TK	35"	36"	3 1/2"	1"	FRLV36TK	38 Sq. In.

## Oval Louver

Brickmould Style



Decorative Part Number	Width	Height	Functional Part Number	Vent Area
OVLV18X24V	18"	24"	FOVLV18X24V	18 Sq. In.
OVLV25X37V	24 1/2"	37"	FOVLV25X37V	24 Sq. In.

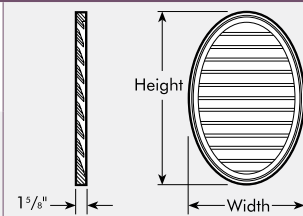



## Triangle Louver

Brickmould Style

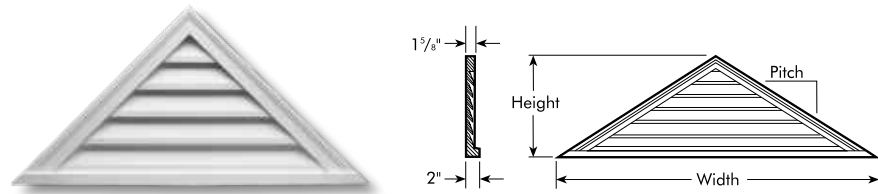

Decorative Part Number	Width	Height	Pitch	Functional Part Number	Vent Area
TRLV36X18	36"	18"	12 / 12	FTRLV36X18	10 Sq. In.
TRLV42X21	42"	21"	12 / 12	FTRLV42X21	18 Sq. In.
TRLV48X12	48"	12"	6 / 12	FTRLV48X12	12 Sq. In.
TRLV48X18	48"	18"	9 / 12	FTRLV48X18	19 Sq. In.
TRLV48X22	48"	22"	11 / 12	FTRLV48X22	27 Sq. In.
TRLV48X24	48"	24"	12 / 12	FTRLV48X24	31 Sq. In.
TRLV60X18	60"	17 1/2"	7 / 12	FTRLV60X18	27 Sq. In.
TRLV60X23	60"	22 1/2"	9 / 12	FTRLV60X23	30 Sq. In.
TRLV60X25	60"	25"	10 / 12	FTRLV60X25	33 Sq. In.
TRLV60X30	60"	30"	12 / 12	FTRLV60X30	51 Sq. In.
TRLV64X27	64"	26 1/2"	10 / 12	FTRLV64X27	34 Sq. In.
TRLV64X32	64"	32"	12 / 12	FTRLV64X32	60 Sq. In.
TRLV66X22	66"	22"	8 / 12	FTRLV66X22	35 Sq. In.
TRLV72X36	72"	36"	12 / 12	FTRLV72X36	79 Sq. In.
TRLV76X19	76"	19"	6 / 12	FTRLV76X19	30 Sq. In.
TRLV84X18	84"	17 1/2"	5 / 12	FTRLV84X18	34 Sq. In.
TRLV84X21	84"	21"	6 / 12	FTRLV84X21	44 Sq. In.
TRLV88X22	88"	22"	6 / 12	FTRLV88X22	38 Sq. In.

## Two-Piece Triangle Louver

Brickmould Style

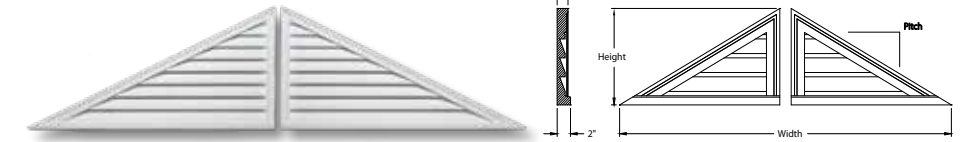

Decorative Part Number	Width	Height	Pitch	Functional Part Number	Vent Area
TRLVLR60X25	60"	25"	10 / 12	FTRLVLR60X25	35 Sq. In.
TRLVLR60X30	60"	30"	12 / 12	FTRLVLR60X30	46 Sq. In.
TRLVLR108X27	108"	27"	6 / 12	FTRLVLR108X27	78 Sq. In.
TRLVLR115X35	115"	34 1/2"	7 1/4 / 12	FTRLVLR115X35	133 Sq. In.
TRLVLR120X30	120"	30"	6 / 12	FTRLVLR120X30	104 Sq. In.

## Diamond Louver

Brickmould Style

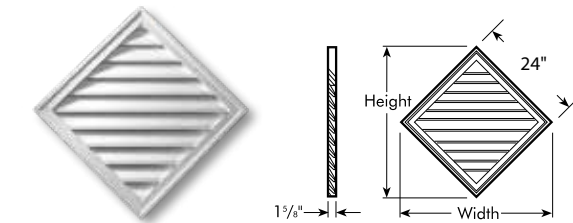

Decorative Part Number	Width	Height	Functional Part Number	Vent Area
DLV24X24	34"	34"	FDLV24X24	32 Sq. In.

## Octagon Louver

Brickmould Style

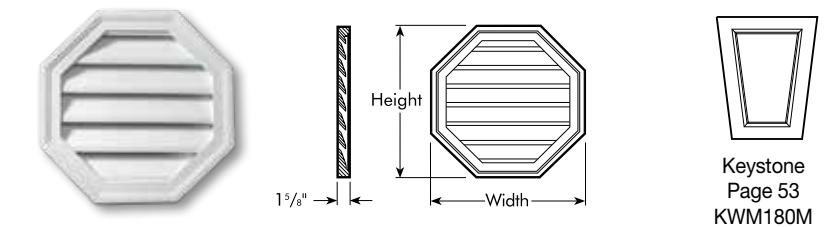

Decorative Part Number	Width	Height	Functional Part Number	Vent Area
OLV18	18"	18"	FOLV18	14 Sq. In.
OLV22	22"	22"	FOLV22	23 Sq. In.
OLV24	24"	24"	FOLV24	29 Sq. In.
OLV28	28"	28"	FOLV28	41 Sq. In.

Parts may be required to ship LTL (less than truckload) based on size and overall dimensions.



# Balustrades, Porch Posts & Columns



Balusters .....	203
Rails.....	210
Installation Aids .....	212
Newel Posts .....	214
Post Accessories.....	216
Structural Columns.....	218
Structural Porch Posts.....	219
Woodgrain Column .....	221
Woodgrain Post Wrap .....	221
Stone Balustrade System.....	222
Stone Half-Round Column .....	223

## Add outdoor sophistication.

Transform any porch, patio or balcony into an impressive outdoor living area. An eye-catching accent for many home designs, our Balustrades, Porch Posts and Columns are beautiful and durable.

### Product Shown:

Square Baluster – BAL2X32SQ  
Top Straight Rail – BTR5X96  
Bottom Straight Rail – BBR5X96  
Newel Post – NP6X48  
Post Top – PST7X7F  
Trim Collar – TC6  
Crush Block – RSB4X4X6





# Balustrades, Porch Posts & Columns

## How to Order

### Balustrade Systems\*

Fypon® Smooth Balustrades are available in three systems: 5", 7" and 12". This size designates the width of the Top and Bottom Rail. In addition to these three sizes, we offer a stone-textured system, which has a 6" wide Top and Bottom Rail.

### Planning Your Layout

#### Balusters

For each Baluster, we have noted a center spacing dimension. This is the maximum center-to-center distance between Balusters that does not allow a 4" ball to pass through at any point. The number of Balusters you need can be found by dividing the rail span, in inches, by the center spacing dimension shown under each part.

**Note: When dividing gives you a fractional result, always round up to the next whole number as shown in the example.**

#### Rail Installation Kits

Each rail section (span between two Newel Posts) will require two Rail Installation Kits. Rail Installation Kits will connect both ends of one rail to a Newel Post or Column.

**Note: Fypon Rail Installation Kits will not work on stair applications. Top and Bottom Rails do not come pre-drilled.**

#### Newel Posts

Each Newel Post will require one Newel Post Installation Kit (NPK) to anchor the base of the Post, as well as any Post Tops, Balls or Trim Collars desired.

### Balustrade System Accessories

Balustrade System accessories are available to help achieve your desired look. All Balustrade accessories are unattached and must be ordered separately.



### Structural Porch Posts & Columns\*

Structural Porch Posts and Columns are reinforced and have load-bearing capacities as noted. Installation hardware is included. Simply choose the Column or Porch Post desired in a height that is equal to or slightly larger than the required height. Porch Posts and Columns can be trimmed to various lengths without impacting load rating. Be sure to order the appropriate quantity of Porch Posts and Columns to adequately support the weight of the load they will carry.

### Remember to Order Adhesive

A urethane-based adhesive **must** be used on all joint surfaces. See page 252 to order Loctite® PL Premium® Adhesive.\*\*

## Baluster Example

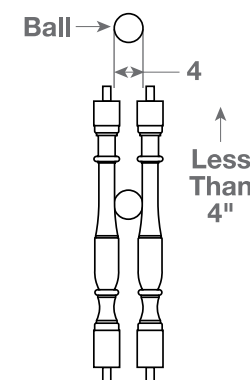

BAL3X20CC – Requires 5" on center spacing

Rail Span ÷ Center Spacing =  
No. of Balusters Needed

$$96" \div 5" = 19.2$$

(Round up to 20)

\* Always consult the local building code authority to determine suitability of products to meet specific project requirements. Images are representative of style, actual product will vary by size.

\*\*Loctite® PL Premium® is owned by Henkel IP & Holding GmbH.



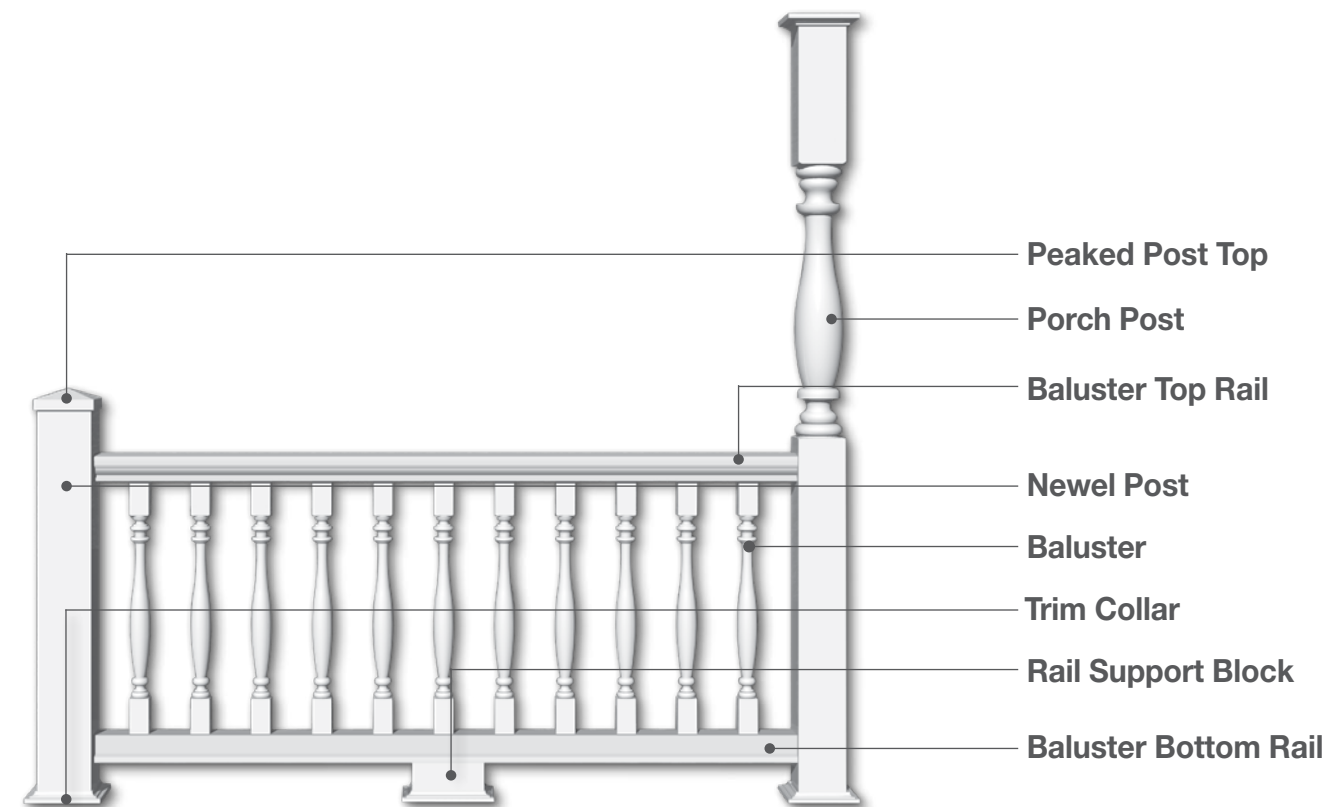

Peaked Post Top



Trim Collar



Baluster Reinforced

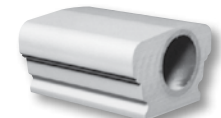

Baluster Top Rail Reinforced

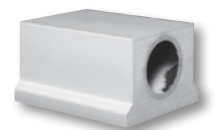

Baluster Bottom Rail Reinforced



Newel Post Reinforced



Load-Bearing Porch Post Reinforced



Rail Support Block

## Ashley Baluster

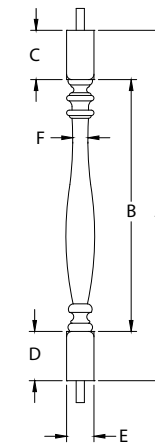

Part Number	Balustrade Rail System	A	B	C	D	E	F	Maximum Center-to-Center Distance
BAL2.5X15AY	5"	15"	9"	3"	3"	2 1/2"	1 7/8"	5 7/8"
BAL3X20AY	5"	20"	15"	2 1/2"	2 1/2"	2 1/2"	1 1/2"	5 3/8"
BAL3X24AY	5"	24"	15"	1 1/2"	4 1/2"	2 1/2"	1 3/8"	5 3/8"
BAL3X28AY	5"	28"	19"	4 1/2"	4 1/2"	2 1/2"	1 3/8"	5 3/8"
BAL3X32AY	5"	32"	23"	4 1/2"	4 1/2"	2 1/2"	1 3/8"	5 3/8"
BAL3X36AY	5"	36"	24"	6"	6"	2 1/2"	1 1/4"	5 1/4"
BAL4X24AY	7"	24"	15"	4 1/2"	4 1/2"	4 1/2"	3 1/2"	7 3/8"
BAL5X24AY	7"	24"	17"	3 1/2"	13 1/2"	4 1/2"	3 1/2"	7 3/8"
BAL5X32AY	7"	32"	23"	4 1/2"	4 1/2"	4 1/2"	3 3/8"	7 3/8"

Note: Baluster images shown above may not be an accurate representation of every size within each category. For additional line art images, visit [www.fypon.com](http://www.fypon.com).

Parts may be required to ship LTL (less than truckload) based on size and overall dimensions.







## Classic Baluster

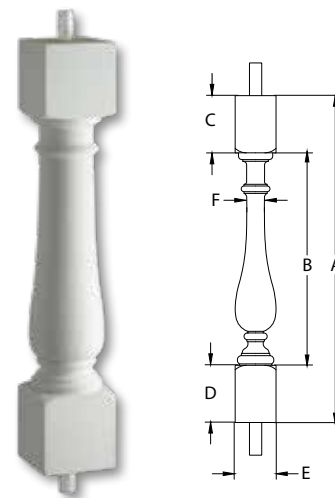

Part Number	Balustrade Rail System	A	B	C	D	E	F	Maximum Center-to-Center Distance
BAL3X20CC	5"	20"	13"	3 1/2"	3 1/2"	2 1/2"	1 1/8"	5"
BAL3X24CC	5"	24"	17"	3 1/2"	3 1/2"	2 1/2"	1 1/8"	5"
BAL3X28CC	5"	28"	21"	3 1/2"	3 1/2"	2 1/2"	1"	5"
BAL3X32CC	5"	32"	25"	3 1/2"	3 1/2"	2 1/2"	1 1/8"	5 1/8"
BAL5X20CC	7"	20"	10"	5"	5"	5"	3 5/8"	7 5/8"
BAL5X24CC	7"	24"	14"	5"	5"	5"	3 5/8"	7 5/8"
BAL5X28CC	7"	28"	18"	5"	5"	5"	3 1/2"	7 1/2"
BAL5X30CC	7"	30 1/2"	20 1/2"	5"	5"	5"	3 5/8"	7 1/2"
BAL5X32CC	7"	32"	22"	5"	5"	5"	3 1/2"	7 1/2"
BAL4X27CCOB	7"	27"	19"	4"	4"	4 1/4"	1 7/8"	5 3/4"
BAL4X31CCOB	7"	31"	23"	4"	4"	4 1/4"	1 1/2"	5 3/4"
BAL5X28CCOB	7"	28"	21 1/8"	3 3/8"	3 3/8"	4 1/2"	2"	5 7/8"
BAL7X28CC	12"	28"	16"	6"	6"	7"	5 1/2"	9 3/8"
BAL7X28CCOB	12"	28"	21 1/4"	3 5/8"	3 3/8"	7"	3 5/8"	7 1/2"



## Beaumont Baluster

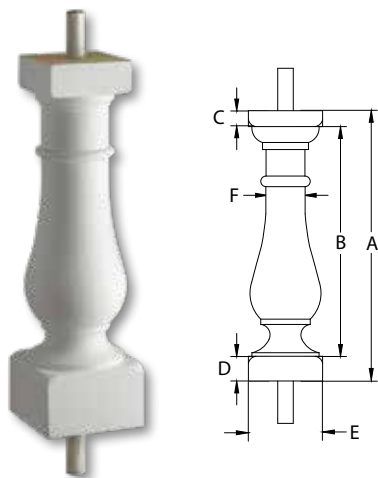

Part Number	Balustrade Rail System	A	B	C	D	E	F	Maximum Center-to-Center Distance
BAL4X22BE	7"	22"	19 1/8"	1 1/8"	1 3/4"	4"	2 3/8"	6 1/4"
BAL5X19BE	7", 12"	19 1/8"	16 1/4"	1 1/8"	1 3/4"	5 1/4"	2 3/4"	6 3/4"
BAL5X22BE	7", 12"	22"	16 1/8"	2 1/8"	3 3/4"	5"	3 1/4"	7 1/8"
BAL5X31BE	12"	31"	24 7/16"	2 1/2"	4 1/8"	5 3/4"	2 7/8"	6 1/8"
BAL6X22BE	12"	21 7/8"	16 1/8"	2 1/8"	3 3/4"	6 1/4"	4"	8"

Note: Baluster images shown above may not be an accurate representation of every size within each category. For additional line art images, visit [www.fypon.com](http://www.fypon.com).

Note: Baluster images shown above may not be an accurate representation of every size within each category. For additional line art images, visit [www.fypon.com](http://www.fypon.com).

Parts may be required to ship LTL (less than truckload) based on size and overall dimensions.



## Logan Baluster

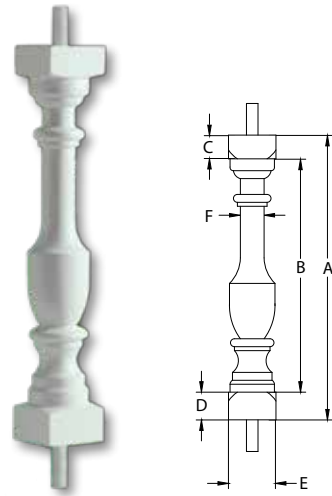

Part Number	Balustrade Rail System	A	B	C	D	E	F	Maximum Center-to-Center Distance
BAL3X24LN	5"	24"	18"	3"	3"	3"	1 1/2"	5 1/2"
BAL3X28LN	5"	28"	22"	3"	3"	3"	1 1/2"	5 1/2"

Note: Baluster images shown above may not be an accurate representation of every size within each category. For additional line art images, visit [www.fypon.com](http://www.fypon.com).

## Woodruff Baluster

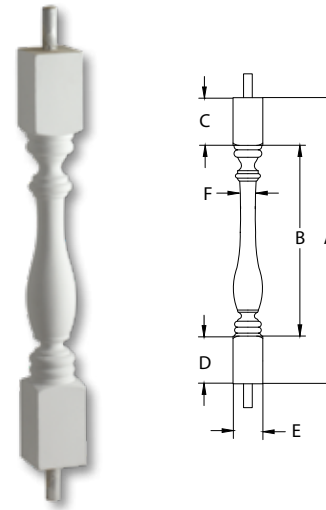

Part Number	Balustrade Rail System	A	B	C	D	E	F	Maximum Center-to-Center Distance
BAL3X18WF	5"	18"	10"	4"	4"	2 1/2"	1 3/8"	5 1/2"
BAL3X20WF	5"	20"	12"	4"	4"	2 1/2"	1 1/4"	5 1/4"
BAL3X24WF	5"	24"	16"	4"	4"	2 1/2"	1 1/4"	5 1/8"
BAL3X28WF	5"	28"	20"	4"	4"	2 1/2"	1 1/4"	5 1/8"
BAL3X32WF	5"	32"	24"	4"	4"	2 1/2"	1 1/4"	5 1/8"
BAL3X36WF	5"	36"	28"	4"	4"	2 1/2"	1 1/2"	5 1/8"
BAL5X24WF	7", 12"	24"	16"	4"	4"	4 1/2"	3 1/4"	7 1/8"
BAL5X28WF	7", 12"	28"	20"	4"	4"	4 1/2"	3 1/2"	7 1/8"
BAL5X32WF	7", 12"	32"	24"	4"	4"	4 1/2"	3 1/2"	7 1/8"

Note: Baluster images shown above may not be an accurate representation of every size within each category. For additional line art images, visit [www.fypon.com](http://www.fypon.com).

Parts may be required to ship LTL (less than truckload) based on size and overall dimensions.

## Rosedale Baluster

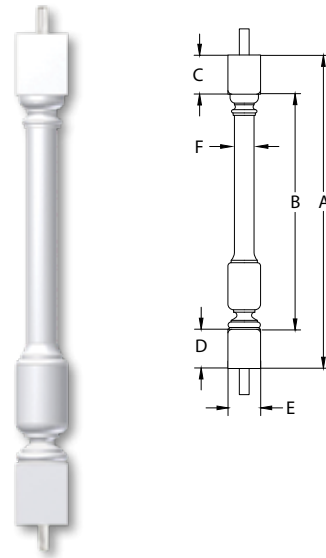

Part Number	Balustrade Rail System	A	B	C	D	E	F	Maximum Center-to-Center Distance
BAL5X20RL	7", 12"	20"	12"	4"	4"	4 1/2"	2 3/4"	6 5/8"

Note: Baluster images shown above may not be an accurate representation of every size within each category. For additional line art images, visit [www.fypon.com](http://www.fypon.com).





# Square Baluster

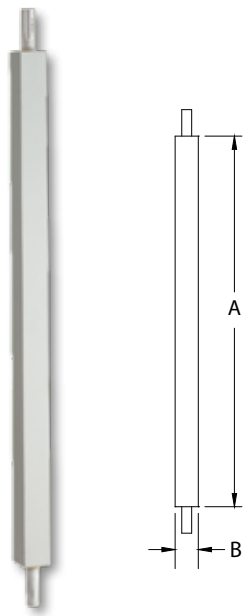

Part Number	Balustrade Rail System	Height (A)	Width (B)	Maximum Center-to-Center Distance
BAL2X20SQ	5"	20"	1 3/4"	5 3/4"
BAL2X24SQ	5"	24"	1 3/4"	5 3/4"
BAL2X28SQ	5"	28"	1 3/4"	5 3/4"
BAL2X32SQ	5"	32"	1 3/4"	5 3/4"



Note: Baluster images shown above may not be an accurate representation of every size within each category. For additional line art images, visit [www.fypon.com](http://www.fypon.com).

Parts may be required to ship LTL (less than truckload) based on size and overall dimensions.





## Top Straight Rails

Top Rail	Part Number	Balustrade Rail System	Length	A	B	C
	BTR5X96	5"	96"	3 1/4"	3 1/8"	4 5/8"
	BTR5X144^	5"	144"	3 1/4"	3 1/8"	4 5/8"
	BTR7X96	7"	96"	5 1/2"	5 1/4"	7"
	BTR7X120^	7"	120"	5 1/2"	5 1/4"	7"
	BTR7X144^	7"	144"	5 1/2"	5 1/4"	7"

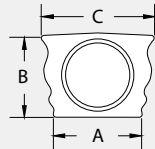
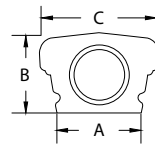

^ Maximum rail span distance for field applications is 96".

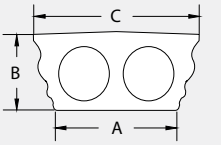

## Top Straight Rails

Top Rail	Part Number	Balustrade Rail System	Length	A	B	C
	BTR12X96	12"	96"	9"	5 1/4"	11 7/8"
	BTR12X120^	12"	120"	9"	5 1/4"	11 7/8"
	BTR12X144^	12"	144"	9"	5 1/4"	11 7/8"



^ Maximum rail span distance for field applications is 96".

## Bottom Straight Rails

Bottom Rail	Part Number	Balustrade Rail System	Length	A	B	C
	BBR5X96	5"	96"	4 1/2"	3 1/8"	3 3/4"
	BBR5X144^	5"	144"	4 1/2"	3 1/8"	3 3/4"
	BBR7X96	7"	96"	7"	5 1/4"	5 1/2"
	BBR7X120^	7"	120"	7"	5 1/4"	5 1/2"
	BBR7X144^	7"	144"	7"	5 1/4"	5 1/2"
	BBR12X96	12"	96"	11 7/8"	5 1/4"	9"
	BBR12X120^	12"	120"	11 7/8"	5 1/4"	9"
	BBR12X144^	12"	144"	11 7/8"	5 1/4"	9"

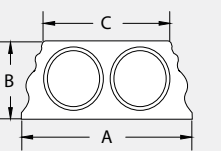
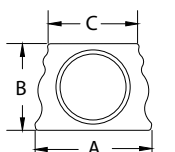
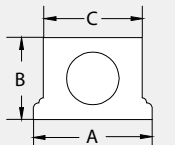

^ Maximum rail span distance for field applications is 96".





Parts may be required to ship LTL (less than truckload) based on size and overall dimensions.





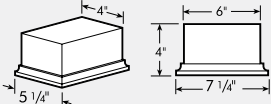

## Installation Aids

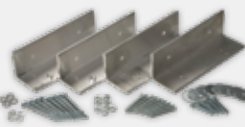
Part Number	Balustrade System	Installation Notes
 RSB4X4X6 Rail Support Block	5", 7", 12"	Install under the Bottom Rail at a span of 48" or less. Dimensions: 4" x 4" x 7 1/4" (may be trimmed for height). 
 BRK5 Rail Installation Kit	5"	Connects both ends of one 5" Top or Bottom Rail to support structure. Order two kits per section. <b>Kit Contents:</b> (2) Angle Brackets & Mounting Hardware
 BRK6-7 Rail Installation Kit	7"	Connects both ends of one 7" Top or Bottom Rail to support structure. Order two kits per section. <b>Kit Contents:</b> (2) Angle Brackets & Mounting Hardware
 BRK12 Rail Installation Kit	12"	Connects both ends of one 12" Top or Bottom Rail to 12" Newel Post or other support. Order two kits per section. <b>Kit Contents:</b> (2) Bear Claw Brackets & Mounting Hardware
 BRK12ANGLBKT Rail Installation Kit	12"	Connects both ends of one 12" Top or Bottom Rail to 13" Newel Post only. Order two kits per section. <b>Kit Contents:</b> (4) Angle Brackets & Mounting Hardware

Parts may be required to ship LTL (less than truckload) based on size and overall dimensions.



## Plain Newel Post

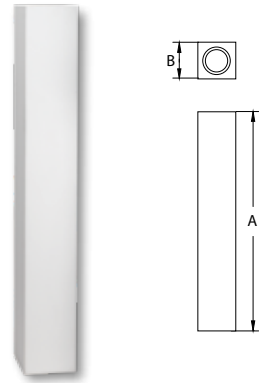

Part Number	Balustrade System	A	B	Accessories
NP6X48	5"	48"	5 1/2"	PST6X6FP PST7X7F TC6
NP8X48	7"	48"	7 1/2"	PST8X8FP PST10X10F TC8

## Decorative Newel Post

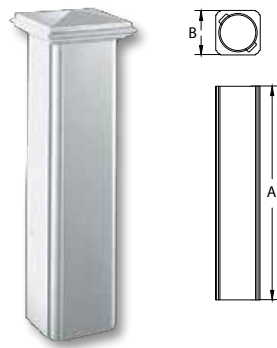

Part Number	Balustrade System	A	B	Accessories
NP10X48	7"	48"	10"	PST11X11FP

Note: Post Tops shown are sold separately.



## Corner Panel Newel Post

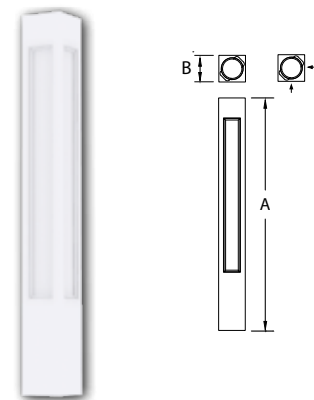

Part Number	Balustrade System	A	B	Accessories
NPCP8X48	7"	48"	8"	PST9X9FP PST10X10F TC8-8
NPCP13X48	12"	48"	12 1/2"	PST13X13FP PST14X14F

## Straight Panel Newel Post

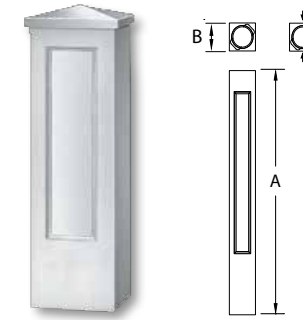

Part Number	Balustrade System	A	B	Accessories
NPSP8X48	7"	48"	8"	PST9X9FP PST10X10F TC8-8
NPSP13X48	12"	48"	12 1/2"	PST13X13FP PST14X14F

Note: Post Tops shown are sold separately.

## Plain Newel Post

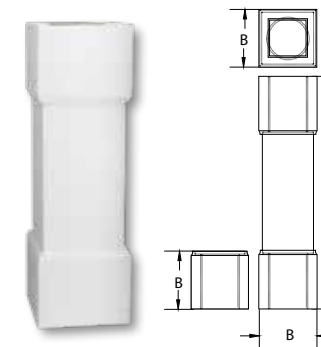

Part Number	Balustrade System	A	B	Accessories
NP12X48	12 "	48"	12"	PST13X13F PST13X13FP

Note: Post Tops shown are sold separately. 3 piece Newel Post.



## Newel Post Installation Kits

Newel Post Installation Kits are sold separately from the Newel Posts. Fasteners to mount steel base plate to the floor surface are not provided.

Installation Kit	Kit Contents
NPK10	Secures one 10" Newel Post to the structural substrate.
NPK12	Secures one 12" Newel Post to the structural substrate.
NPK13	Secures one 13" Newel Post to the structural substrate.
NPK400	Secures one 6" Newel Post to the structural substrate.
NPK600	Secures one 8" Newel Post to the structural substrate.

Parts may be required to ship LTL (less than truckload) based on size and overall dimensions.

# Post Accessories

Part Number	Balustrade System	Bottom Width (A)	Top Width (B)	Height (C)	Accessories
 B5X7 Ball Top	5", 7"	4 3/8"	5 1/4"	6 3/4"	PST7X7F
B10X13 Ball Top	12"	8 1/2"	10"	12 7/8"	PST13X13F PST14X14F
PST6X6FP Fancy Peaked Top	5"	5 7/8"	—	2 1/8"	NP6X48
PST8X8FP Fancy Peaked Top	7"	8 1/8"	—	3"	NP8X48
 PST9X9FP Fancy Peaked Top	7"	8 7/8"	—	3"	NPCP8X48 NPSP8X48
Note: Image shown represents Fancy Peaked Tops.					
PST11X11FP Fancy Peaked Top	7"	10 3/4"	—	4 1/2"	—
PST13X13FP Fancy Peaked Top	12"	13 1/4"	—	4 5/8"	NP12X48 NPCP13X48 NPSP13X48

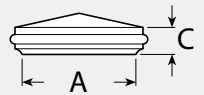
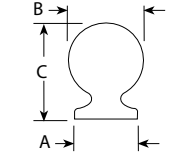

Parts may be required to ship LTL (less than truckload) based on size and overall dimensions.





## Post Accessories

Part Number	Balustrade System	Bottom Width (A)	Top Width (B)	Height (C)	Accessories
PST7X7F Flat Post Top	5"	6 1/2"	4 1/2"	1 1/2"	NP6X48
 PST10X10F Flat Post Top	7"	9 1/2"	6 1/4"	2"	NP8X48 NPCP8X48 NPSP8X48
Note: Image represents Flat Post Tops.					
PST13X13F Flat Post Top	12"	12 1/2"	8 5/8"	1 1/2"	B10X13 NP12X48
PST14X14F Flat Post Top	12"	14"	8 3/4"	3 1/8"	B10X13 NPCP13X48 NPSP13X48

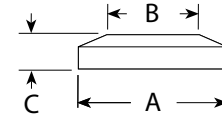

 TC6 Trim Collar	5"	9 1/8"	5 5/8"	2"	NP6X48
TC8 Trim Collar	7"	11 1/8"	7 5/8"	2"	NP8X48
Note: Image shown represents Trim Collars.					
TC8-8 Trim Collar	7"	11 1/8"	8 1/8"	2"	NP8X48

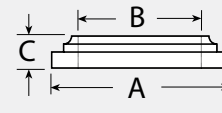

## Panel Square Column

Structural

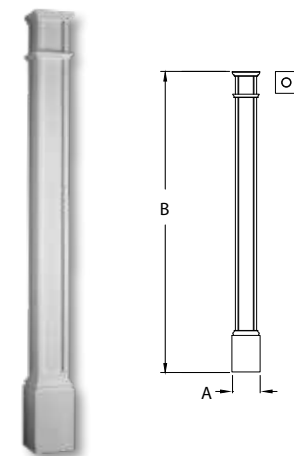

Part Number	Width	Base Width (A)	Height (B)	Base Height	Load Bearing Capacity
COL8X96PSQ	6 1/8"	8"	96"	13 5/8"	12,000#
COL11X96PSQ	8"	10 1/2"	96"	13 3/4"	12,000#
COL11X108PSQ	8"	10 5/8"	108"	12 3/4"	12,000#

Note: Installation Kit included.

## Vintage Porch Post

Structural

Part Number	Width (A)	Overall Height (B)	Bottom Block Height (C)	Load Bearing Capacity	Balustrade System
PP8X120A	7 1/2"	120"	42"	12,000#	7"

Note: Installation Kit included. Porch Posts can be field trimmed to various heights without losing load rating.

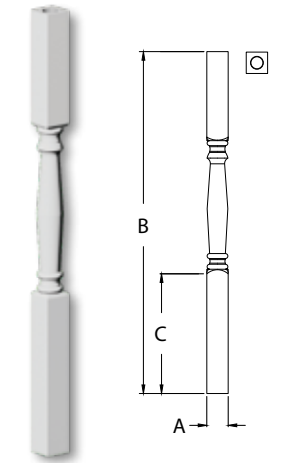

## Colonial Porch Post

Structural

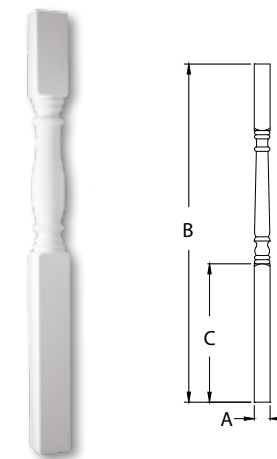

Part Number	Width (A)	Overall Height (B)	Bottom Block Height (C)	Load Bearing Capacity	Balustrade System
PP5X102	4 3/4"	101 1/4"	41 1/2"	6,000#	5"
PP6X96	5 1/2"	96"	44 1/2"	6,000#	5"
PP6X108	5 1/2"	108"	44 1/2"	6,000#	5"
PP6X120	5 1/2"	120"	44 1/2"	6,000#	5"

Note: Installation Kit included. Porch Posts can be field trimmed to various heights without losing load rating.

## Lamp Post

Non-Structural / Decorative

Part Number	Bottom Width (A)	Top Width (B)	Height (C)	Pipe Diameter
LP6X96	5 1/2"	3 1/2"	96"	2 7/8"

Note: Non-structural pipe extends 1 3/4" beyond top of Post.

Parts may be required to ship LTL (less than truckload) based on size and overall dimensions.

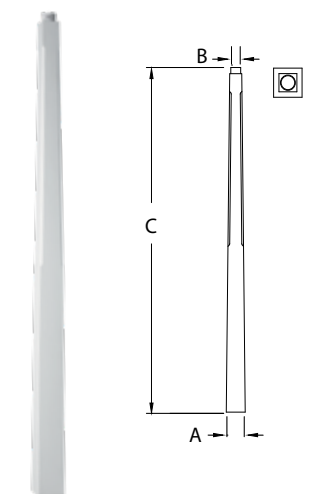



## Column

Woodgrain - Structural

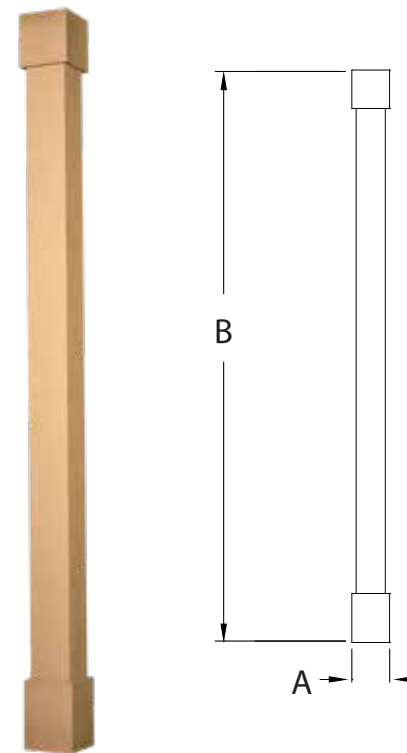

Part Number	Width (A)	Height (B)	Load Bearing Capacity
PPSQKIT6X108S	7"	108"	12,000#

Note: Installation Kit included. Column can be field trimmed to various heights without losing load rating. Cap is 9 5/8" x 7" and base is 9 5/8" x 9".

## Post Wrap

Woodgrain - Non-Structural

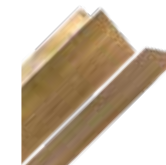

PSTWKIT8X96S

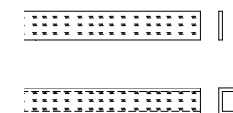

PSTWBASE8S

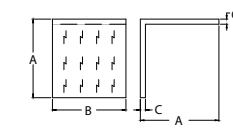

PSTWCAP8S

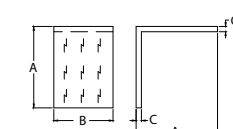

Part Number	Width (A)	Height (B)	Thickness (C)
<b>PSTWKIT8X96S</b> Post Wrap Kit Ships in 2 pieces. Dimensions are assembled size.	7 1/2" x 9"	96"	1"
<b>Kit Contents:</b> (1) 3-Sided Wrap - PSTW8X96S (1) Backer - PSTBB8X96S			

<b>PSTWBASE8S</b> Post Wrap Base Ships in 2 L-shaped halves.	9 5/8"	9"	5/8"
--	--------	----	------

<b>PSTWCAP8S</b> Post Wrap Cap Ships in 2 L-shaped halves.	9 5/8"	7"	5/8"
--	--------	----	------

Inside width is 5 1/2" x 7" fits over 4" x 4" treated Post.

Parts may be required to ship LTL (less than truckload) based on size and overall dimensions.



## Stone Euro Baluster\*

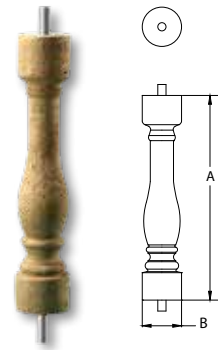



Part Number	Height (A)	Width (B)	Maximum Center-to-Center Distance
BAL5X28EUST	27 7/8"	5 3/8"	7 5/8"

\* 1 1/8" X 30 3/4" Fiberglass pipe molded into Baluster.

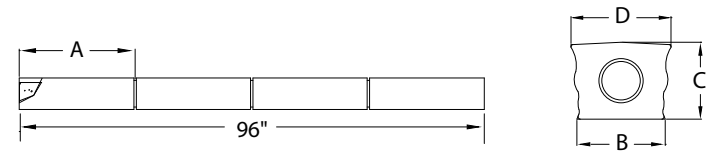
## Stone Rails\*



Part Number	Length	Molded Rail Section (A)	Width (B)	Height (C)	Overall Width (D)
 BTR6X96ST	96"	23 7/8"	5 3/4"	5"	6 1/2"
 BBR6X96ST	96"	23 7/8"	5 5/8"	4 7/8"	6 1/4"

\* Always consult the local building code authority to determine suitability of products to meet specific requirements, as well as adhesive manufacturer's recommendations for your particular climate and the substrate you are installing to.



## Stone Newel Post

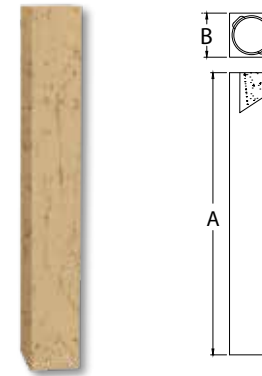

Part Number	A	B	Installation Kit	Accessories
NP8X48ST	48"	7 1/2"	NPK600	PST10X10PST

## Stone Post Cap

Part Number	A	B
 PST10X10PST	9 1/2"	3"

## Stone Half-Round Column

Non-Structural / Decorative

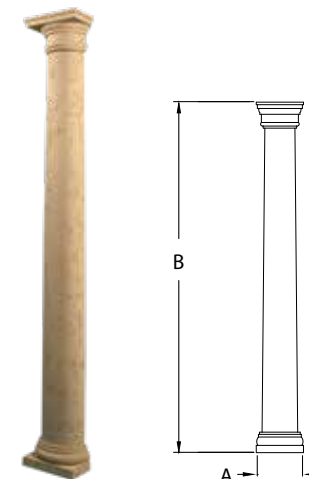

Part Number	Width (A)	Height (B)	Projection
HRCBCC96X12ST Tapered Kit Kit ships in 3 pieces and creates one half column. Order two kits to create a full column.	15"	110 1/4"	11 3/4"
<b>Kit Contents:</b> (1) Cap Half [CC15ST] (1) Shaft Half [HRCB96X12ST] (1) Base Half [CB15ST]			

Parts may be required to ship LTL (less than truckload) based on size and overall dimensions.



# PVC Column Wraps



Structural Post .....	228
ProSelect Square Column Wraps .....	228
PremiumSelect Square Column Wraps .....	231
Square Cap & Base Accessories .....	232
PremiumSelect Tapered Column Wraps .....	234
Tapered Cap & Base Accessories .....	237

## Coverage with character.

Once you've met the structural requirements of your project, Fypon® PVC Column Wraps can be used to add an elegant finishing touch. Designed for easy installation around an existing structural support, Column Wraps are perfect for adding character to a new job or covering an existing, outdated design. Order any quantity of Fypon Column Wraps and they will ship in 5 business days or we will pay \$500 per order.

**Product Shown:**  
Column Wrap – PremiumSelect CWPM8X108SFT





# PVC Column Wraps

## How to Order

### Column Wraps\*

Fypon® Column Wraps are non-structural and simply wrap around an existing treated wood post or other structural support. PremiumSelect come in a complete kit (installation kit sold separately for ProSelect) that includes shaft, cap, base, installation cleat, hardware and tube of adhesive, and installation materials. Choose between various Tapered and Square styles with a height that meets or exceeds your height requirement. Flat Panel Column Wraps can be trimmed to any height, and all other styles are trimmable from the bottom of the shaft up to 3".

### Column Wrap Accessories

Square Column Wraps come with the Traditional Cap and Base. Tapered Column Wraps come with the Craftsman Cap and Base. Six additional Cap and Base styles are available and can be ordered separately. Simply choose a style and specify the type (Square or Tapered) and the nominal size of the Column Wrap you are matching. Most of the Caps and Bases are constructed of PVC (unless otherwise noted) and ship in four separate pieces with pre-mitered corners.

### Special Order Products

PremiumSelect products shown in the catalog are available in additional sizes. Product may be modified to minimum 6" width to a 24" maximum width. The height may also be modified with a minimum height of 48" to a maximum of 144" height (maximum 108" for tapered).

### Remember to Order Adhesive

A urethane-based adhesive **must** be used on all joint surfaces. See page 252 to order Loctite® PL Premium® Adhesive.\*\*



## Flexible Positioning PremiumSelect Column Wraps

Fypon Column Wraps allow for flexibility in positioning. The design features installation cleats on the exterior of the shaft for PremiumSelect providing ample room around the support post. This allows for positioning adjustments to align several columns in a row or to allow for positioning close to the porch edge. Also, because the Column Wrap does not come in contact with the structural post, the integrity of the wrap is not dependent on the support.

Before you order, you'll want to measure to make sure you have enough clear distance from the support post to the edge of the porch. The needed space is dependent on the style of column. You will need more space for tapered columns than square due to the larger base.

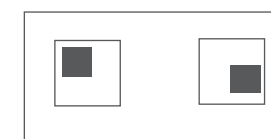

Flexible positioning around support post

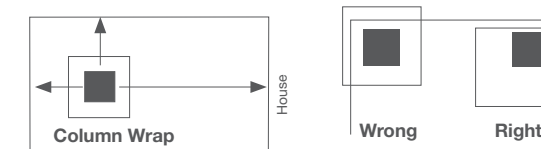

Allow adequate distance when choosing wrap width.

\* Always consult the local building code authority to determine suitability of products to meet specific project requirements. Images are representative of style, actual product will vary by size.

\*\* Loctite® PL Premium® is owned by Henkel IP & Holding GmbH.



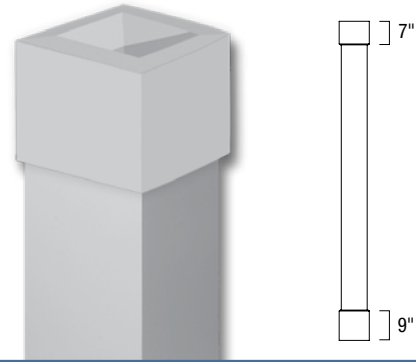

# ProSelect Square Column Wraps

Semi-Assembled Flat Panel with Plain Cap & Base\*



Shaft Width	Height	Flat Panel (FT)
<b>6"</b> (5 3/4" Actual) 4" Actual Inside Width	6' (72")	CWPR6X72SFT
	8' (96")	CWPR6X96SFT
	9' (108")	CWPR6X108SFT
	10' (120")	CWPR6X120SFT
	12' (144")	CWPR6X144SFT
<b>8"</b> (7 3/4" Actual) 4 7/8" Actual Inside Width	6' (72")	CWPR8X72SFT
	8' (96")	CWPR8X96SFT
	9' (108")	CWPR8X108SFT
	10' (120")	CWPR8X120SFT
	12' (144")	CWPR8X144SFT
<b>10"</b> (9 3/4" Actual) 6 7/8" Actual Inside Width	6' (72")	CWPR10X72SFT
	8' (96")	CWPR10X96SFT
	9' (108")	CWPR10X108SFT
	10' (120")	CWPR10X120SFT
	12' (144")	CWPR10X144SFT
<b>12"</b> (11 3/4" Actual) 8 7/8" Actual Inside Width	6' (72")	CWPR12X72SFT
	8' (96")	CWPR12X96SFT
	9' (108")	CWPR12X108SFT
	10' (120")	CWPR12X120SFT
	12' (144")	CWPR12X144SFT

## Accessories

Description	Height	Part Number
 Installation Kit includes adhesive and screw pack.	—	CWINSTALLKIT
 <b>NEW</b> Aluminum Structural Post with a load bearing capacity of 5,000 lbs. Kit includes aluminum post, 4X4 post mount and screws.	96"	STRPOSTKIT96
	108"	STRPOSTKIT108
	120"	STRPOSTKIT120

\*Installation Kit sold separately.

Note: Installation Cleats are to be applied inside shaft.

ProSelect is not available for special orders.

Parts may be required to ship LTL (less than truckload) based on size and overall dimensions.







# PremiumSelect Square Column Wraps

Semi-Assembled with Traditional Cap & Base

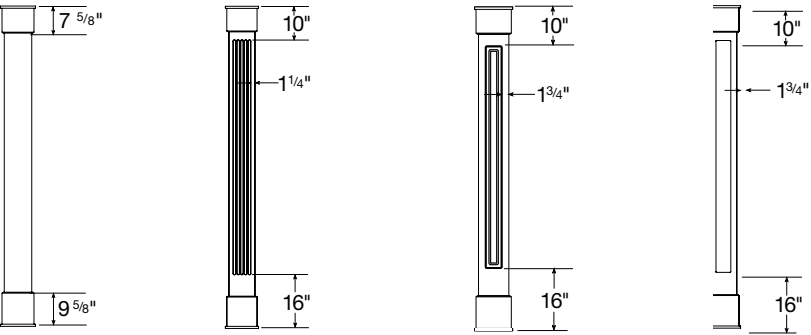

Flutes are  $\frac{5}{8}$ " wide and  $\frac{1}{4}$ " deep. Number and spacing of flutes varies by width of shaft.  
 Route is  $1\frac{11}{32}$ " wide by  $\frac{3}{8}$ " deep.  
 Recess is  $\frac{1}{2}$ " deep and corners are  $\frac{1}{4}$ " rounded.

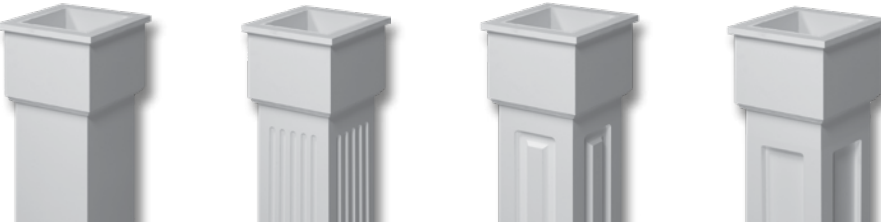







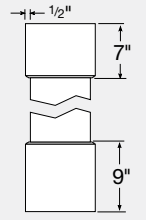
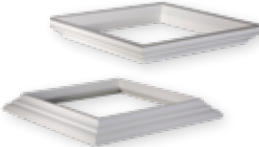
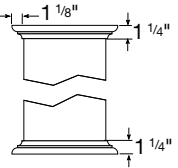
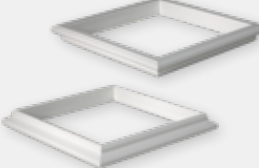
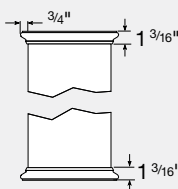

Shaft Width	Height	Flat Panel (FT)	Fluted (FL)	Raised Panel (RS)	Recessed Panel (RC)
<b>6"</b> (5 3/4" Actual)	6' (72")	CWPM6X72SFT	—	—	—
	8' (96")	CWPM6X96SFT	—	—	—
	9' (108")	CWPM6X108SFT	—	—	—
	10' (120")	CWPM6X120SFT	—	—	—
	12' (144")	CWPM6X144SFT	—	—	—
4 3/4" Actual Inside Width					
<b>8"</b> (7 3/4" Actual)	6' (72")	CWPM8X72SFT	CWPM8X72SFL	CWPM8X72SRS	CWPM8X72SRC
	8' (96")	CWPM8X96SFT	CWPM8X96SFL	CWPM8X96SRS	CWPM8X96SRC
	9' (108")	CWPM8X108SFT	CWPM8X108SFL	CWPM8X108SRS	CWPM8X108SRC
	10' (120")	CWPM8X120SFT	CWPM8X120SFL	CWPM8X120SRS	CWPM8X120SRC
	12' (144")	CWPM8X144SFT	CWPM8X144SFL	CWPM8X144SRS	CWPM8X144SRC
6 3/4" Actual Inside Width				5 3/4" Actual Inside Width	
<b>10"</b> (9 3/4" Actual)	6' (72")	CWPM10X72SFT	CWPM10X72SFL	CWPM10X72SRS	CWPM10X72SRC
	8' (96")	CWPM10X96SFT	CWPM10X96SFL	CWPM10X96SRS	CWPM10X96SRC
	9' (108")	CWPM10X108SFT	CWPM10X108SFL	CWPM10X108SRS	CWPM10X108SRC
	10' (120")	CWPM10X120SFT	CWPM10X120SFL	CWPM10X120SRS	CWPM10X120SRC
	12' (144")	CWPM10X144SFT	CWPM10X144SFL	CWPM10X144SRS	CWPM10X144SRC
8 3/4" Actual Inside Width				7 3/4" Actual Inside Width	
<b>12"</b> (11 3/4" Actual)	6' (72")	CWPM12X72SFT	CWPM12X72SFL	CWPM12X72SRS	CWPM12X72SRC
	8' (96")	CWPM12X96SFT	CWPM12X96SFL	CWPM12X96SRS	CWPM12X96SRC
	9' (108")	CWPM12X108SFT	CWPM12X108SFL	CWPM12X108SRS	CWPM12X108SRC
	10' (120")	CWPM12X120SFT	CWPM12X120SFL	CWPM12X120SRS	CWPM12X120SRC
	12' (144")	CWPM12X144SFT	CWPM12X144SFL	CWPM12X144SRS	CWPM12X144SRC
10 3/4" Actual Inside Width				9 3/4" Actual Inside Width	

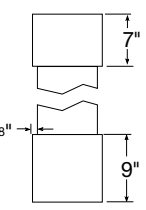
Note: Installation Cleats are applied on the exterior of the shaft.  
 Tip: Fypon Column Wraps won't twist with L-shaped installation methodology.  
 Parts may be required to ship LTL (less than truckload) based on size and overall dimensions.

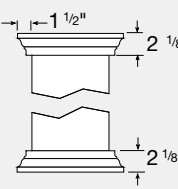

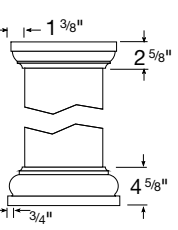
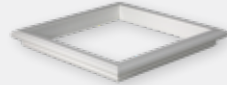
# Square Cap & Base Accessories

Style	6X6	8X8	10X10	12X12
<b>Traditional</b>  	CWCB6TR	CWCB8TR	CWCB10TR	CWCB12TR
Ships standard with all PremiumSelect Square Column Wrap Kits.				
<b>Craftsman</b>  	CWCB6CF	CWCB8CF	CWCB10CF	CWCB12CF
<b>Greek</b>  	CWCB6GK	CWCB8GK	CWCB10GK	CWCB12GK
<b>Plain</b>  	CWCB6PL	CWCB8PL	CWCB10PL	CWCB12PL
Ships standard with all ProSelect Square Column Wrap Kits.				
<b>Roman</b>  	CWCB6RO	CWCB8RO	CWCB10RO	CWCB12RO
<b>Tuscan</b>  	CWCB6TS	CWCB8TS	CWCB10TS	CWCB12TS
Tuscan Cap and Base are high-density polyurethane.				
<b>Neck Mould</b>  	CW6NM	CW8NM	CW10NM	CW12NM

Cleats ship with Column Wrap Shaft.





# PremiumSelect Tapered Column Wraps

Semi-Assembled with Craftsman Cap & Base

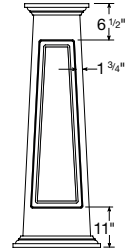
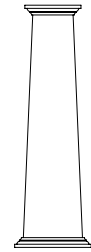

Route is 1 3/8" wide by 3/8" deep.

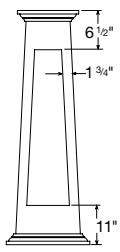

Recess is 1/2" deep and corners are 1/4" rounded.



Shaft Width	Height	Flat	Raised Panel	Recessed Panel
<b>8"</b> Top (7 3/4" Actual)	4' (48")	CWPM8X12X48TFT	CWPM8X12X48TRS	CWPM8X12X48TRC
	4 1/2' (54")	CWPM8X12X54TFT	CWPM8X12X54TRS	CWPM8X12X54TRC
	5' (60")	CWPM8X12X60TFT	CWPM8X12X60TRS	CWPM8X12X60TRC
<b>12"</b> Bottom (11 3/4" Actual)	5 1/2' (66")	CWPM8X12X66TFT	CWPM8X12X66TRS	CWPM8X12X66TRC
	6' (72")	CWPM8X12X72TFT	CWPM8X12X72TRS	CWPM8X12X72TRC
	8' (96")	CWPM8X12X96TFT	CWPM8X12X96TRS	CWPM8X12X96TRC
<b>11"</b> Top (10 3/4" Actual)	4' (48")	CWPM11X16X48TFT	CWPM11X16X48TRS	CWPM11X16X48TRC
	4 1/2' (54")	CWPM11X16X54TFT	CWPM11X16X54TRS	CWPM11X16X54TRC
	5' (60")	CWPM11X16X60TFT	CWPM11X16X60TRS	CWPM11X16X60TRC
<b>16"</b> Bottom (15 3/4" Actual)	5 1/2' (66")	CWPM11X16X66TFT	CWPM11X16X66TRS	CWPM11X16X66TRC
	6' (72")	CWPM11X16X72TFT	CWPM11X16X72TRS	CWPM11X16X72TRC
	8' (96")	CWPM11X16X96TFT	CWPM11X16X96TRS	CWPM11X16X96TRC
<b>13"</b> Top (12 3/4" Actual)	4' (48")	CWPM13X20X48TFT	CWPM13X20X48TRS	CWPM13X20X48TRC
	4 1/2' (54")	CWPM13X20X54TFT	CWPM13X20X54TRS	CWPM13X20X54TRC
	5' (60")	CWPM13X20X60TFT	CWPM13X20X60TRS	CWPM13X20X60TRC
<b>20"</b> Bottom (19 3/4" Actual)	5 1/2' (66")	CWPM13X20X66TFT	CWPM13X20X66TRS	CWPM13X20X66TRC
	6' (72")	CWPM13X20X72TFT	CWPM13X20X72TRS	CWPM13X20X72TRC
	8' (96")	CWPM13X20X96TFT	CWPM13X20X96TRS	CWPM13X20X96TRC
<b>16"</b> Top (15 3/4" Actual)	4' (48")	CWPM16X24X48TFT	CWPM16X24X48TRS	CWPM16X24X48TRC
	4 1/2' (54")	CWPM16X24X54TFT	CWPM16X24X54TRS	CWPM16X24X54TRC
	5' (60")	CWPM16X24X60TFT	CWPM16X24X60TRS	CWPM16X24X60TRC
<b>24"</b> Bottom (23 3/4" Actual)	5 1/2' (66")	CWPM16X24X66TFT	CWPM16X24X66TRS	CWPM16X24X66TRC
	6' (72")	CWPM16X24X72TFT	CWPM16X24X72TRS	CWPM16X24X72TRC
	8' (96")	CWPM16X24X96TFT	CWPM16X24X96TRS	CWPM16X24X96TRC

Parts may be required to ship LTL (less than truckload) based on size and overall dimensions.

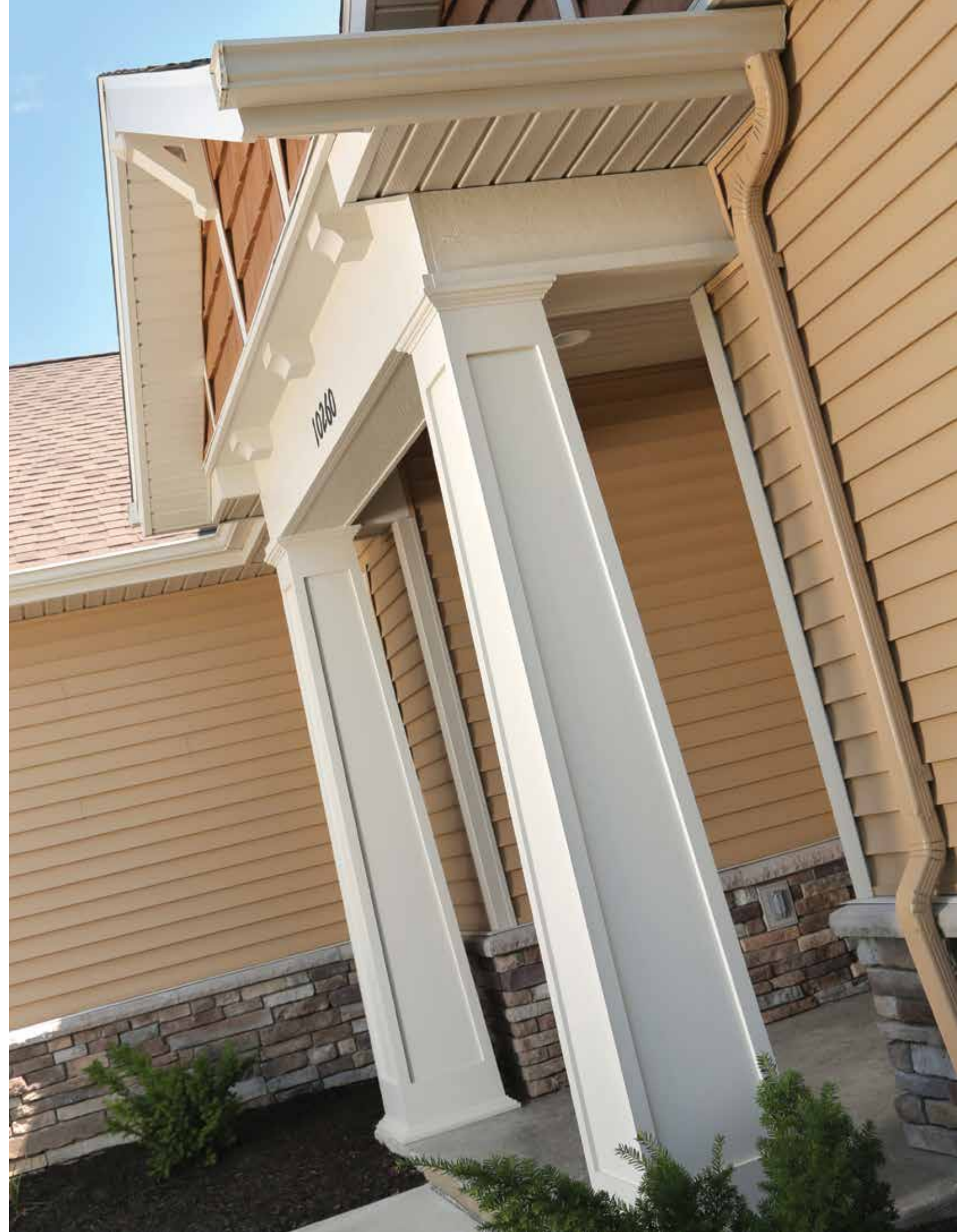







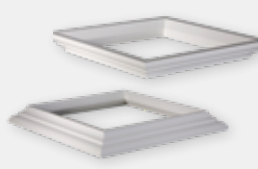
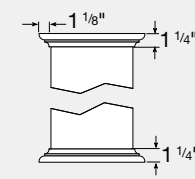

Approved

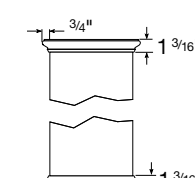

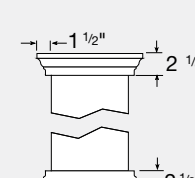
## Tapered Cap & Base Accessories

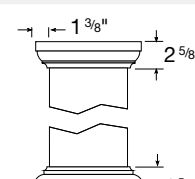
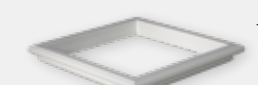
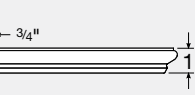
Style	8X12	11X16	13X20	16X24
<b>Craftsman</b>  	CWCB8X12CF	CWCB11X16CF	CWCB13X20CF	CWCB16X24CF
Ships standard with all PremiumSelect Tapered Column Wrap Kits.				
<b>Greek</b>  	CWCB8X12GK	CWCB11X16GK	CWCB13X20GK	CWCB16X24GK
<b>Roman</b>  	CWCB8X12RO	CWCB11X16RO	CWCB13X20RO	CWCB16X24RO
<b>Tuscan</b>  	CWCB8X12TS	CWCB11X16TS	CWCB13X20TS	CWCB16X24TS
Tuscan Cap & Base are high-density polyurethane.				
<b>Neck Mould</b>  	CW17NM	Trimmable to fit up to 16" wide top width.		

Cleats ship with Column Wrap Shaft.



# QuickRail® Systems



Straight & Stair Rail Kits .....	243
Complete Post Kits .....	244
Ultra Post Kits .....	244
Post Sleeves & Accessories .....	245
Gate Kits .....	246
Bracket & Adapter Kits .....	247
Individual Components .....	248
QuickPost® Synthetic Porch Post .....	249
DuraPoly® Synthetic Porch Post .....	250
Grab Rail Handrail System .....	251

## Beauty made easy.

Discover beautiful railings, made more durable through our special manufacturing process. Low-maintenance and resistant to decay, our QuickRail System products come with simple, step-by-step installation instructions, ensuring they live up to their name.

**Product Shown:**  
QuickRail Straight Rail Kit – 740636SQDF  
QuickRail Synthetic Porch Post – 40500588SQ





# QuickRail® Systems

## How to Use This Section

For ease of use, the product groupings in this section of the catalog are organized by size, from smallest to largest, where applicable. Each product chart includes product images, dimensional data and part numbers to help specify, source and sell Fypon® QuickRail Synthetic Railing Systems.

## How to Order

### QuickRail Systems

QuickRail Kits are available for both straight and stair applications. Each kit includes a Deluxe Top Rail, a Flat Bottom Rail, Spindles, a Crush Block<sup>^</sup>, Brackets, Bracket Covers and the necessary screws for fast installation. Rail Kits can be attached to a wall, Newel Post or Porch Post.

Note: QuickRail Stair Rail Kits cannot be attached to round columns or 45° post applications.

Plan your layout by determining the size and configuration of your porch, including any stairs. The most important step to building your order is creating an accurate layout. Check local building codes to determine minimum guardrail height, maximum rail span and structural post requirements for your area. Determine the number of Rail and Post Kits you need to accommodate your layout.

Next, choose Spindle style. Then find the part number of the Rail Kit that meets your style, length and height requirements.

Finally, determine size and style of any accessories needed to achieve the desired look.

### QuickRail System Accessories

A variety of accessories are available to create your own unique system, including Post Kits, Post Sleeves, Gate Kits, Porch Posts and Grab Rails. If you have an application where additional or unique connections are required, Bracket and Adapter Kits are sold separately. Individual components are also sold separately.

### Special Order Products

Some products shown in this catalog include special order options. This means the product is available in additional sizes or with additional accessories. Throughout this section, special order part numbers are marked with an asterisk (\*).

### Remember to Order Adhesive

A urethane-based adhesive **must** be used on all joint surfaces. See page 252 to order Loctite® PL Premium® Adhesive.\*

\* Loctite® PL Premium® is owned by Henkel IP & Holding GmbH.

\*\* Always consult the local building code authority to determine suitability of products to meet specific project requirements. Images are representative of style, actual product will vary by size.

<sup>^</sup> Stair Rail System does not include crush block.



## Building Code Compliance\*\*

QuickRail System products are building code compliant when installed on structural surfaces no more than 30" above ground. The 8' and 10' Rail Kits include a Top Rail aluminum insert that must be used in any installation. The 6' Rail Kits do not require an insert. In applications above 30", only rail lengths of 10' or less mounted between our Ultra Post Kits or 4"x4" Posts with Post Sleeves are building code compliant. The Complete Post Kit with Standard Post Mount can only be installed in applications that are less than 30" above ground.

Fypon has received confirmation from ICC Evaluation Service, LLC (ICC-ES), that its QuickRail Synthetic Railing Systems comply with the provisions of the International Building Code and International Residential Code. The ICC-ES confirmation, published in evaluation report ESR-2601, will help code officials approve use of QuickRail Systems under the codes. The Fypon evaluation report is available online at [www.icc-es.org](http://www.icc-es.org).

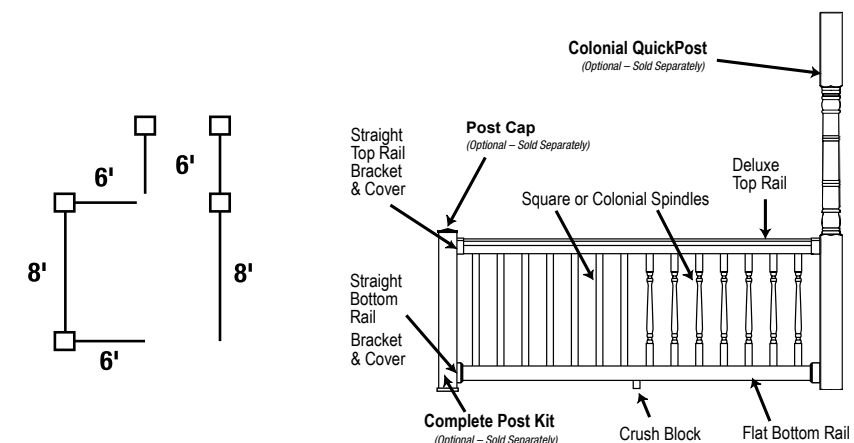





## QuickRail® Railing Kits

### Options & Features

- Height Options: 36" or 42" guardrail height.
- Length Options: 6', 8', 10' or 12' nominal length.
- Spindle Options: Colonial or Square.
- Finish Color: White (standard) or Tan (special order).
- Application: Straight or stair (30°-40° slope).
- Additional Accessories: Multi-angle Brackets, 45° adapters and curved adapters are available as special order.
- Conveniently packaged in one box, each kit includes a Top Rail, a Bottom Rail, Spindles, Brackets, Bracket Covers, a Crush Block\*\*, structural insert\* and screws.

### Kit Contents

#### Straight & Stair Rail Kits

Each straight or stair rail kit includes the following:

- Deluxe Top Rail
- Top Rail Structural Insert (Not Included in 6' Kits)
- Colonial or Square Spindles
- Bottom Rail
- Crush Block\*\*
- Brackets & Bracket Covers
- Screw Pack

### Finish Colors

QuickRail products come in our vibrant White or Tan UV-protected finish.

Note: Printed colors may not be an accurate representation of actual product color.

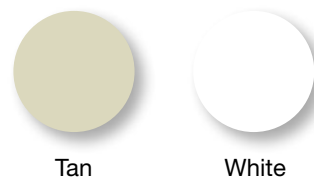

Tan

White

\*Structural insert is not included in the 6' Kit.

\*\*Crush Block not included in Stair Rail Kits.

Note: Always consult the local building code authority to determine suitability.



Deluxe Rail with Square Spindles  
(Posts Sold Separately)



Deluxe Rail with Colonial Spindles  
(Posts Sold Separately)

## Straight & Stair Rail Kits

### QuickRail Straight Rail Kits\*\*

Deluxe Rail with Square or Colonial Spindles (Posts Sold Separately)

Note: Colonial Spindle spacing is 3 1/4". Square Spindle spacing is 3 7/8".

Description	Hand Rail Height	Spindle Style	No. of Spindles	Actual Rail Length	Bracket Style	White Part Number	Tan Part Number
6' Deluxe Rail Kit	36"	Colonial	14	70 1/2"	Straight	740636CLDF	74T636CLDF*
6' Deluxe Rail Kit	36"	Square	13	72"	Straight	740636SQDF	74T636SQDF*
6' Deluxe Rail Kit	42"	Square	13	72"	Straight	740642SQDF*	74T642SQDF*
8' Deluxe Rail Kit	36"	Colonial	19	94 1/8"	Straight	740836CLDF	74T836CLDF*
8' Deluxe Rail Kit	36"	Square	17	96"	Straight	740836SQDF	74T836SQDF*
8' Deluxe Rail Kit	42"	Square	17	96"	Straight	740842SQDF	74T842SQDF*
10' Deluxe Rail Kit	36"	Colonial	24	117 3/4"	Straight	741036CLDF	74T1036CLDF*
10' Deluxe Rail Kit	36"	Square	22	120"	Straight	741036SQDF	74T1036SQDF*
10' Deluxe Rail Kit	42"	Square	22	120"	Straight	741042SQDF	74T1042SQDF*
12' Deluxe Rail Kit	36"	Colonial	29	141 1/2"	Straight	741236CLDF*	74T1236CLDF*
12' Deluxe Rail Kit	36"	Square	26	144"	Straight	741236SQDF	74T1236SQDF*
12' Deluxe Rail Kit	42"	Square	26	144"	Straight	741242SQDF	74T1242SQDF*

Note: 8' and 10' Rail Kits include aluminum rail insert. Aluminum rail inserts come in kits only.

Note: Code compliant when installed in structural surfaces no more than 30" above ground.

### QuickRail Stair Rail Kits\*\*

Deluxe Stair Rail with Square or Colonial Spindles (Posts Sold Separately)

Note: Colonial Spindle spacing is 3 1/4". Square Spindle spacing is 3 7/8".

Description	Hand Rail Height	Spindle Style	No. of Spindles	Actual Rail Length	Bracket Style	White Part Number	Tan Part Number
6' Deluxe Stair Rail Kit	36"	Colonial	11	78"	Stair	740636CLDS	74T636CLDS*
6' Deluxe Stair Rail Kit	36"	Square	11	78"	Stair	740636SQDS	74T636SQDS*
6' Deluxe Stair Rail Kit	42"	Square	11	78"	Stair	740642SQDS*	74T642SQDS*
8' Deluxe Stair Rail Kit	36"	Colonial	15	102"	Stair	740836CLDS	74T836CLDS*
8' Deluxe Stair Rail Kit	36"	Square	15	102"	Stair	740836SQDS	74T836SQDS*
8' Deluxe Stair Rail Kit	42"	Square	15	102"	Stair	740842SQDS	74T842SQDS*
10' Deluxe Stair Rail Kit	36"	Colonial	19	126"	Stair	741036CLDS	74T1036CLDS*
10' Deluxe Stair Rail Kit	36"	Square	19	126"	Stair	741036SQDS	74T1036SQDS*
10' Deluxe Stair Rail Kit	42"	Square	19	126"	Stair	741042SQDS*	74T1042SQDS*

\*Part numbers marked with an asterisk (\*) are special order.

\*\*Always consult the local building code authority to determine suitability.

Parts may be required to ship LTL (less than truckload) based on size and overall dimensions.



# System Accessories

## Complete Post Kits

The Complete Post Kit comes with a Standard Post Mount and can be used to connect rail sections on substrates with elevation of 30" or less. Complete Post Kits include a Cap, Base, Standard PVC Post Mount and the necessary hardware for installation on both pressure-treated wood decking and masonry surfaces.

**Kit Contents:**  
 (1) Post Sleeve  
 (1) Taper Cap  
 (1) Post Base  
 (1) Standard PVC Post Mount  
 (1) Hardware Kit

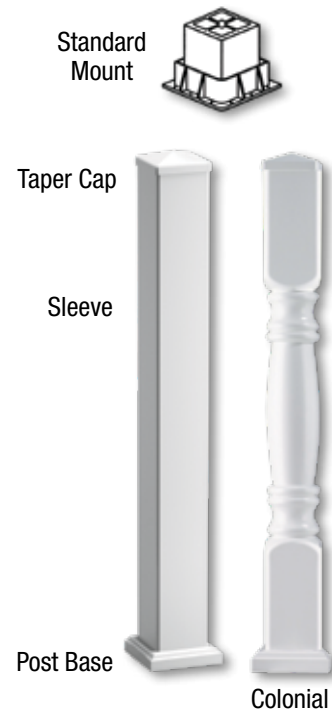

Post Size	Inside Width	Post Height	White Part Number	Tan Part Number
4" x 4" x 38"	3 5/8"	38"	40050438PK Plain Square	4T050438PK* Plain Square
4" x 4" x 38"	3 5/8"	38"	40050438CPK* Colonial	—
4" x 4" x 44"	3 5/8"	44"	40050444PK Plain Square	4T050444PK* Plain Square
Hardware Kit	Hardware Kit is included in all Complete Post Kits, but can also be purchased separately.		4005ACQHDR	

## Ultra Post Kits

The Ultra Post is a structural, commercial-grade Newel Post that can be used on substrates with elevations higher than 30". Ultra Post Kits include a Cap, Base, Structural Post Mount and the necessary hardware for installation on either wood / composite or concrete / masonry surfaces.

**Kit Contents:**  
 (1) Post Sleeve  
 (1) Structural Post Mount  
 (1) Mounting Hardware (for Pressure-Treated Wood or Masonry)  
 (1) Taper Cap  
 (1) Post Base

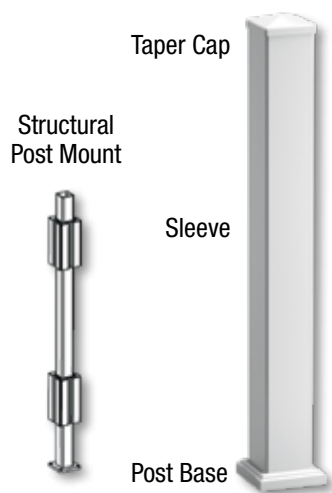

Post Size	Inside Width	Post Height	Substrate	White Part Number	Tan Part Number
4" x 4" x 38"	3 5/8"	38"	Wood or Composite	70050438WPK*	70T50438WPK*
4" x 4" x 38"	3 5/8"	38"	Concrete or Masonry	70050438CPK*	70T50438CPK*
4" x 4" x 44"	3 5/8"	44"	Wood or Composite	70050444WPK*	70T50444WPK*
4" x 4" x 44"	3 5/8"	44"	Concrete or Masonry	70050444CPK*	70T50444CPK*

\*Part numbers marked with an asterisk (\*) are special order.  
 Note: Straight Rail Systems are code compliant 30" and greater above ground when used with Ultra Post Kit.

# System Accessories

## Post Sleeves & Accessories

The Post Sleeve is a one-piece, hollow design that slides over an existing 4"x4" or 5"x5" support post. Post Sleeves can be accented with a variety of Caps and Bases to customize your system.

Post Sleeve	Sleeve Style	Sleeve Size	Inside Width	Structural Support Size	White Part Number	Tan Part Number
	Plain	4" x 4" x 38"	3 5/8"	3 1/2"	40050438PS	4T050438PS*
	Plain	4" x 4" x 44"	3 5/8"	3 1/2"	40050444PS*	4T050444PS*
	Plain	4" x 4" x 48"	3 5/8"	3 1/2"	40050448PS*	4T050448PS*
	Plain	4" x 4" x 60"	3 5/8"	3 1/2"	40050460PS*	4T050460PS*
	Plain	4" x 4" x 96"	3 5/8"	3 1/2"	40050408PS*	4T050408PS*
	Plain	4" x 4" x 108"	3 5/8"	3 1/2"	40050409PS*	4T050409PS*
	Plain	5" x 5" x 38"	4 5/8"	4 1/2"	40050538PS*	—
	Recessed	5" x 5" x 38"	4 5/8"	4 1/2"	40050538RPPS*	—
	Plain	5" x 5" x 44"	4 5/8"	4 1/2"	40050544PS*	—
	Plain	5" x 5" x 96"	4 5/8"	4 1/2"	40050508PS*	—
	Plain	5" x 5" x 108"	4 5/8"	4 1/2"	40050509PS*	—

\*Part numbers marked with an asterisk (\*) are special order.



Parts may be required to ship LTL (less than truckload) based on size and overall dimensions.



# System Accessories

Post Caps and Bases	Size and Style	Height	White Part Number	Tan Part Number
	4" Taper Cap	1 1/8"	40040404TC	4T040404TC*
	5" Taper Cap	1 1/8"	40040505TC*	—
	4" Ball Cap	4 5/8"	40040404BC*	4T040404BC*
	5" Ball Cap	5 3/4"	40040505BC*	—
	4" Gothic Cap	7 3/4"	40040404GC*	4T040404GC*
	5" Gothic Cap	9 3/4"	40040505GC*	—
	4" New England Cap	1 3/4"	40040404NC*	4T040404NC*
	5" New England Cap	2 1/8"	40040505NC*	—
	4" New England Base^	1 1/2"	40040404PB*	4T040404PB*
	5" New England Base	1 7/8"	40040505PB*	—

^ Not compatible with Complete Post Kit.

## Gate Kits

Gate Kits come with a latch, hinges and mounting hardware, and are available in 36" and 42" heights. The Gate Kit components are pre-cut to fit a 37 1/2" wide opening but can be trimmed for smaller applications. Be sure to check local building codes for any dimension requirements when planning your system layout.

### Kit Contents:

- (1) Deluxe Top Rail
- (1) Flat Bottom Rail
- (5) Spindles (Colonial or Square)
- (2) Post Sleeves
- (2) Taper Caps
- (1) Gate Hardware Kit

**IMPORTANT:** Gate Kit should NOT be attached to Complete Post Kit. It is recommended to attach the Gate Kit to a structural 4"x4" or 5"x5" treated post covered with a Post Sleeve.





Description	Spindle Style	Gate Width	Kit Height	White Part Number	Tan Part Number
34" x 36" Gate Kit	Square	35"	36"	4436SQDFGK	44T36SQDFGK*
34" x 36" Gate Kit	Colonial	35"	36"	4436CLDFGK*	44T36CLDFGK*
34" x 42" Gate Kit	Square	35"	42"	4442SQDFGK*	44T42SQDFGK*

Note: This product can only be installed on structural surfaces less than 30" above ground.

\*Part numbers marked with an asterisk (\*) are special order.

# System Accessories

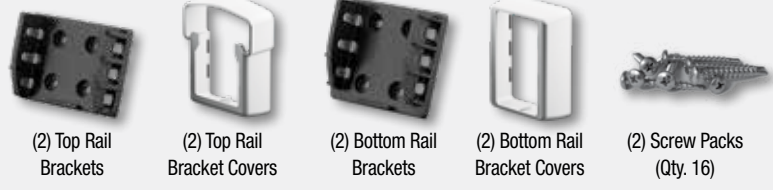
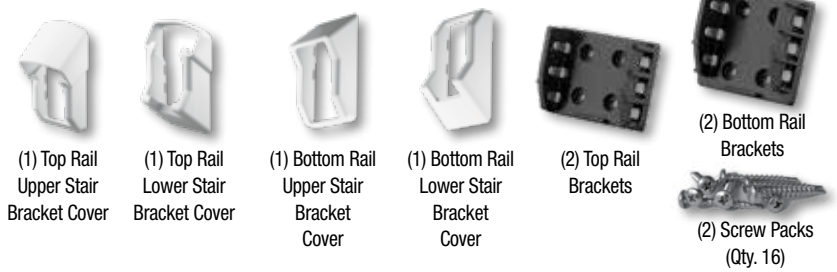
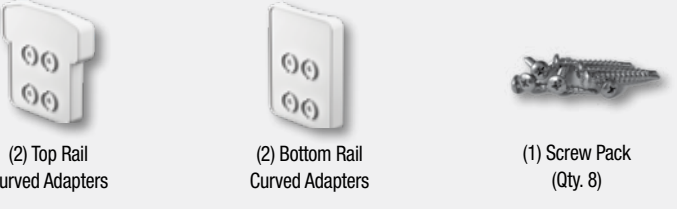
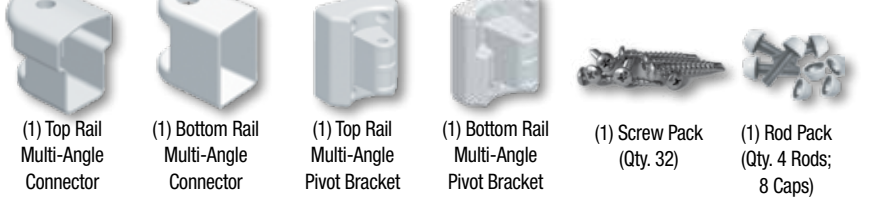
## Bracket & Adapter Kits

Kit Name	For use with QuickRail®	White Part Number	Tan Part Number
<b>Straight Bracket Kit</b>	For use with QuickRail® Straight Rail Kits.	440900DFBK*	44T900DFBK*
			
<b>Stair Bracket Kit</b>	For use with QuickRail® Stair Rail Kits.	4409DFSUBK*	44T9DFSUBK*
			
<b>Curved Adapter Kit</b>	To connect QuickRail® Straight Rail Kits to round columns.	440900DCBK*	74T700DCBK*
			
<b>Multi-Angle Bracket Kit</b>	For use with QuickRail® Straight Rail Kits in 22.5°-45° applications.	44070DFMBK*	44T70DFMBK*
			
<b>45° Corner Post Bracket Kit</b>	For use with QuickRail® Straight Rail Kits in 45° applications.	74070FFPBK*	74T70FFPBK*
			

\*Part numbers marked with an asterisk (\*) are special order.

Parts may be required to ship LTL (less than truckload) based on size and overall dimensions.

# Individual Components

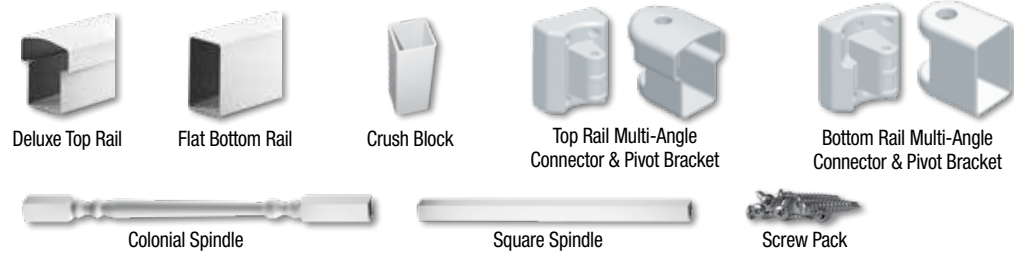

Description	White Part Number	Tan Part Number
6' Deluxe Top Rail - for Colonial Spindles	4407060CTR*	44T7060CTR*
6' Deluxe Top Rail - for Square Spindles	4407060STR*	44T7060STR*
6' Flat Bottom Rail - for Colonial Spindles	4007060CBR*	4T07060CBR*
6' Flat Bottom Rail - for Square Spindles	4007060SBR*	4T07060SBR*
6' Deluxe Stair Rail - for Colonial / Square Spindles	4407060SSR*	44T7060SSR*
6' Flat Stair Rail - for Colonial / Square Spindles	4007060SLR*	4T07060SLR*
8' Deluxe Rail - for Colonial Spindles	4407080CTR*	44T7080CTR*
8' Deluxe Rail - for Square Spindles	4407080STR*	44T7080STR*
8' Flat Bottom Rail - for Colonial Spindles	4007080CBR*	4T07080CBR*
8' Flat Bottom Rail - for Square Spindles	4007080SBR*	4T07080SBR*
8' Deluxe Stair Top Rail - for Colonial / Square Spindles	4407080SSR*	44T7080SSR*
8' Flat Stair Bottom Rail - for Colonial / Square Spindles	4007080SLR*	4T07080SLR*
10' Deluxe Rail - for Colonial Spindles	4407010CTR*	44T7010CTR*
10' Deluxe Rail - for Square Spindles	4407010STR*	44T7010STR*
10' Flat Bottom Rail - for Colonial Spindles	4007010CBR*	4T07010CBR*
10' Flat Bottom Rail - for Square Spindles	4007010SBR*	4T07010SBR*
10' Deluxe Sloped Top Rail - for Colonial / Square Spindles	4407010SSR*	44T7010SSR*
10' Flat Stair Bottom Rail - for Colonial / Square Spindles	4007010SLR*	4T07010SLR*
12' Deluxe Rail - for Colonial Spindles	4407012CTR*	44T7012CTR*
12' Deluxe Rail - for Square Spindles	4407012STR*	44T7012STR*
12' Flat Bottom Rail - for Colonial Spindles	4007012CBR*	4T07012CBR*
12' Flat Bottom Rail - for Square Spindles	4007012SBR*	4T07012SBR*
Colonial Spindle (1 1/2" x 1 1/2" x 33 1/2") for 6' kits	40043305CS*	—
Colonial Spindle (1 1/2" x 1 1/2" x 32 3/4") for 8', 10' & 12' kits	44043275CS*	44T43275CS*
Square Spindle (1 1/2" x 1 1/2" x 33 1/2") for 6' kit 36" height	40043305SS*	—
Square Spindle (1 1/2" x 1 1/2" x 32 3/4") for 8', 10' & 12' kits 36" height	44043275SS*	44T43275SS*
Square Spindle (1 1/2" x 1 1/2" x 39 1/2") for 6' kit 42" height	40043905SS*	—
Square Spindle (1 1/2" x 1 1/2" x 38 3/4") for 8', 10' & 12' kits 42" height	44043875SS*	44T43875SS*
Crush Block (1 1/2" x 8")	40071000CB*	4T071000CB*
Top Rail Multi-Angle Connector and Pivot Bracket (Includes 1 Rod and 2 Caps)	4407040MCT*	44T7040MCT*
Bottom Rail Multi-Angle Connector and Pivot Bracket (Includes 1 Rod and 2 Caps)	4407040MCB*	44T7040MCB*
Screw Pack (Qty. 32)	44070320SX*	44T70320SX*

\* Part numbers marked with an asterisk (\*) are special order.  
 Note: Top Rail metal inserts are only included in the kit. When Top Rails are purchased individually, the metal insert is not included.

# QuickPost® Synthetic Porch Post

## Structural Post with Lifetime Finish

QuickPost Synthetic Porch Posts are the perfect complement to our QuickRail Systems. Featuring the same lifetime finish as all QuickRail System components, the vibrant color is virtually maintenance-free and never needs to be painted.

- Structural Post with steel insert.
- Precise Colonial detail.
- Trim to fit your project.
- Designed for use with QuickRail Systems.
- Virtually maintenance-free.
- Limited lifetime warranty.<sup>^</sup>

## Product Details

- Shell is composed of UV-protected vinyl.
- Internal core includes a structural, galvanized steel tube.
- Kit includes mounting plates and screws.
- Trim Kit available (sold separately).

## Product Options

- Sizes: 5" or 6" nominal width (Actual widths are 4 1/4" or 5 1/4").
- Finish colors: White (standard) or Tan (special order).
- Accessories: Trim Kit available (sold separately).

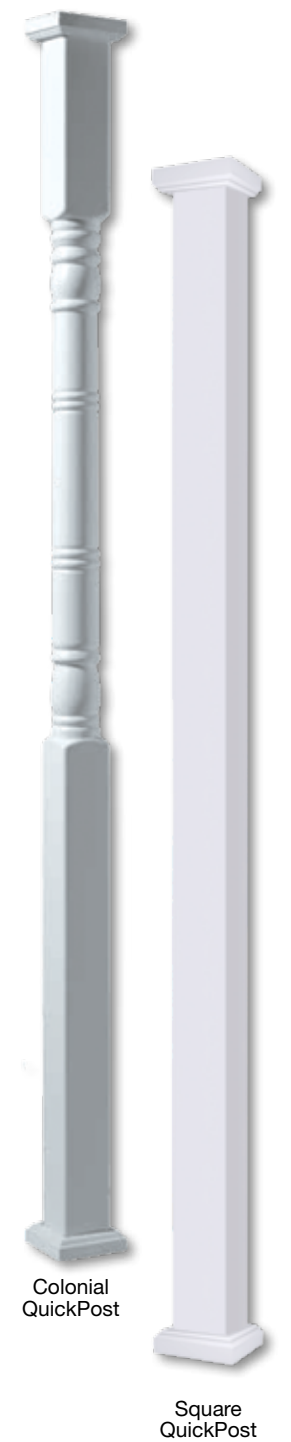
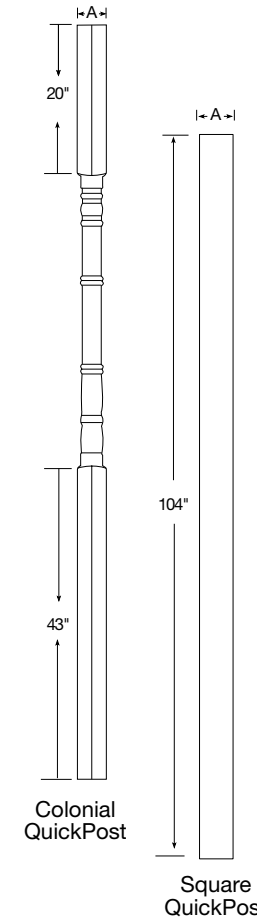

## QuickPost Synthetic Porch Post

Post Size	Actual Width (A)	Load Bearing Capacity	White Part Number	Tan Part Number	Post Style
4" x 4" x 8' 8"	4"	3,000#	40500488SQ	—	Square
5" x 5" x 8' 8"	5"	5,000#	40500588SQ	—	Square
5" x 5" x 8' 8"	4 1/4"	3,000#	40500588CL	4T500588CL*	Colonial
6" x 6" x 8' 8"	5 1/4"	5,000#	40500688CL	4T500688CL*	Colonial

## QuickPost Trim Kits (Sold Separately)

Trim Kit Size	White Part Number	Tan Part Number	Post Style
5" Trim Kit Fits 5" QuickPost	40020505TK	4T020505TK*	Colonial
6" Trim Kit Fits 6" QuickPost	400600PWTK	4T020606TK*	Colonial
4" Trim Kit Fits 4" QuickPost	405004SQTK	—	Square
5" Trim Kit Fits 5" QuickPost	405005SQTK	—	Square



\* Part numbers marked with an asterisk (\*) are special order.  
<sup>^</sup> For complete details on our warranty, visit [www.fypon.com](http://www.fypon.com).  
 Note: Dimensional drawings are approximate representations. Do not scale.  
 Parts may be required to ship LTL (less than truckload) based on size and overall dimensions.



# DuraPoly® Synthetic Porch Post

## DuraPoly Synthetic Porch Post

Post Size	Actual Width (A)	Load Bearing Capacity	White Part Number	Post Style
4" x 4" x 8' 8"	4 1/4"	3,000#	80500588CL	Colonial
5" x 5" x 8' 8"	5 1/4"	5,000#	80500688CL	Colonial

## DuraPoly Post Trim Kits (Sold Separately)

Trim Kit Size	White Part Number	Post Style
5" Trim Kit Fits 4" DuraPoly Post	800500PWTk	Colonial
5" Trim Kit Fits 5" DuraPoly Post	800600PWTk	Colonial

DuraPoly Porch Post and Trim Kits can be painted.

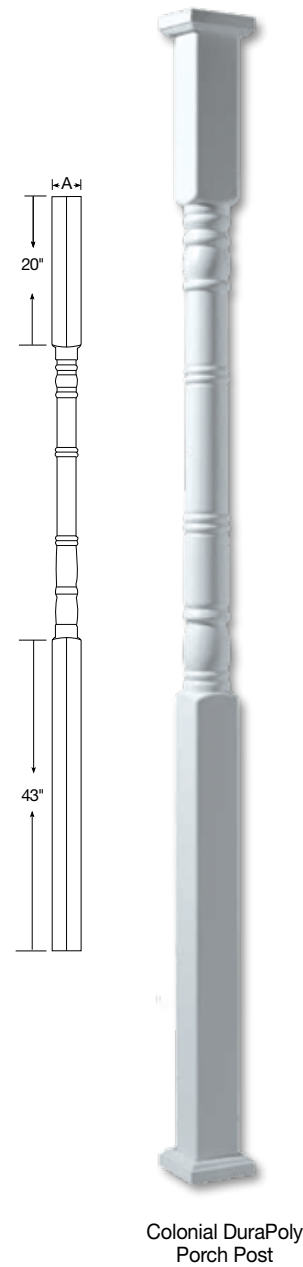

Colonial DuraPoly Porch Post



Colonial Trim Kit Sold Separately

# Grab Rail Handrail System

Fypon® Grab Rail perfectly complements all QuickRail® Synthetic Railing Systems. The Grab Rail System is easy to install and can be mounted to QuickRail Complete Post Kits (in applications less than 30" above ground) or an existing wall. Important: The illustration below is intended to show how the system components are used together. Grab Rail must be attached to a guard rail in applications above 30".

- Meets ADA requirements.
- White UV-protected finish resists fading.
- Never needs painting.
- Can be used with QuickRail Systems.
- Virtually maintenance-free.
- Limited lifetime warranty.^

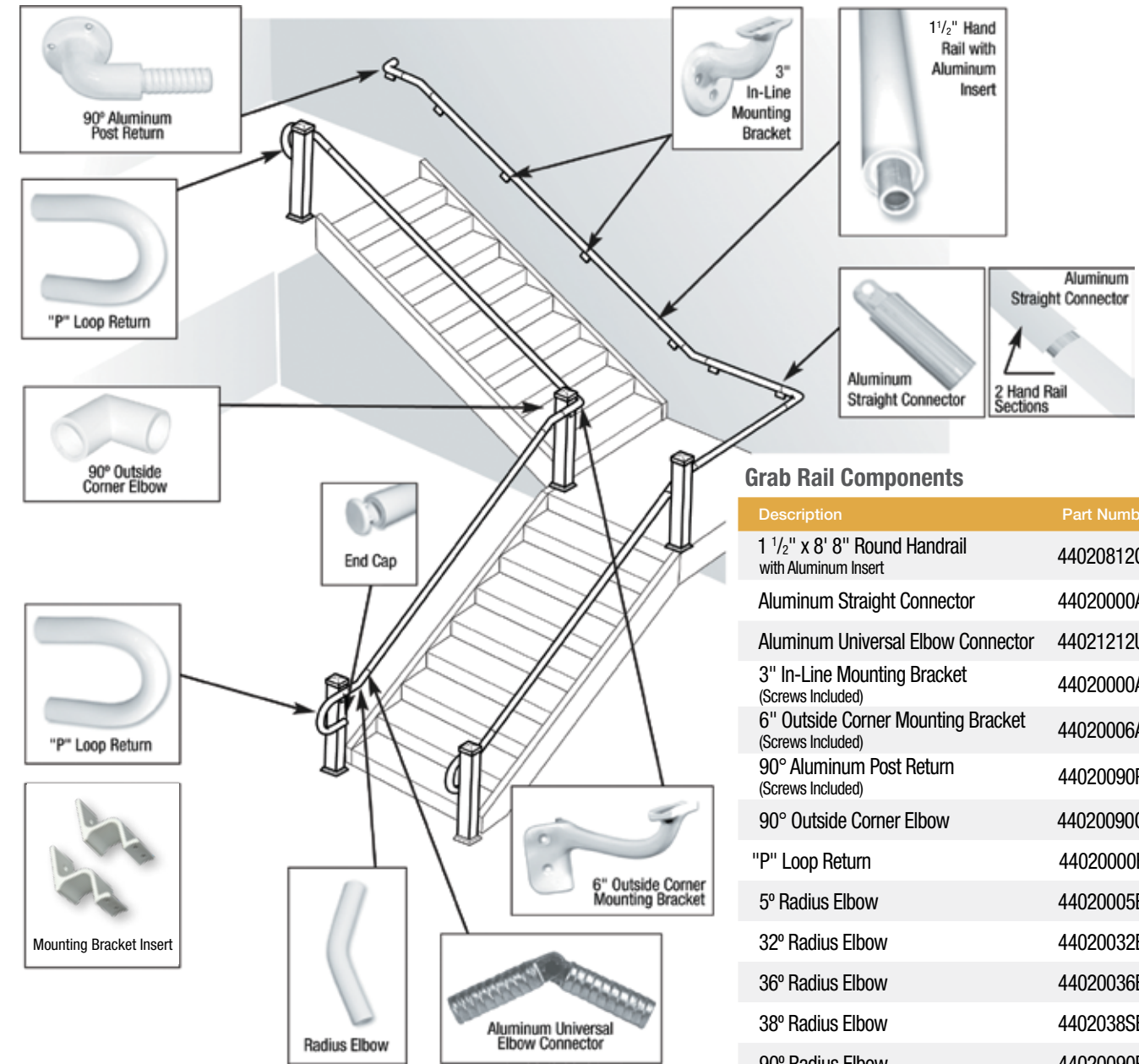

## Grab Rail Components

Description	Part Number
1 1/2" x 8' 8" Round Handrail with Aluminum Insert	44020812GR*
Aluminum Straight Connector	44020000AC*
Aluminum Universal Elbow Connector	44021212UC*
3" In-Line Mounting Bracket (Screws Included)	44020000AB*
6" Outside Corner Mounting Bracket (Screws Included)	44020006AB*
90° Aluminum Post Return (Screws Included)	44020090PR*
90° Outside Corner Elbow	44020090OC*
"P" Loop Return	44020000EL*
5° Radius Elbow	44020005EB*
32° Radius Elbow	44020032EB*
36° Radius Elbow	44020036EB*
38° Radius Elbow	44020038EB*
90° Radius Elbow	44020090RE*
End Caps	44020000EC*
Mounting Bracket Insert	44020000MB*

\* Part numbers marked with an asterisk (\*) are special order.  
 ^ For complete details on our warranty, visit [www.fypon.com](http://www.fypon.com).

Parts may be required to ship LTL (less than truckload) based on size and overall dimensions.

NEW

ALL ORDERS\*

PRODUCT  
UNDER 8'  
\$25PRODUCT 8'  
OR LONGER  
\$125

## NATIONWIDE Everyday Flat Rate Shipping

INCLUDES SMOOTH, WOODGRAIN, COLUMN WRAP &amp; QUICKRAIL PRODUCTS

\*Exceptions Apply - See Beam Freight Policy

## Adhesive & Finishing

A urethane-based adhesive such as Loctite® PL Premium® Construction Adhesive\* must be used on all joints when installing urethane products. This will minimize the effects of expansion and contraction on the product. For additional information on adhesives, detailed installation instructions and finishing information, visit [fypon.com](http://fypon.com).

## Loctite® PL Premium® Adhesive

Part Number	Description
ADH1 Loctite PL Premium Adhesive	(1) 10.2 oz. Cartridge

## Considerations for Installation

Fypon reserves the right to make changes to our product with the assurance that we will meet or exceed quality requirements. Changes to product could include standardization across parts that may impact blocking applications, but visual impact will not be noticeable and parts will align. If it is critical to have consistency between parts for installation purposes, please speak with your Customer Service Representative prior to placing your order at 800-446-3040.

Material Comparison	Fypon® Polyurethane	Wood	Composite
May Be Placed Against Masonry	YES	NO	NO
Above-Grade Distance Requirement**	0"	8"	6"
Water Absorption	NO	YES	YES
Insect Resistant	YES	NO	NO
Moisture Resistant	YES	NO	NO
Pre-Drilling Required When Edge Nailing	NO	YES	YES
Requires Sanding, Priming & Sealing	NO	YES	YES
Painting (Number of Coats Needed)***	1	2	2
Quality	Consistent quality, no waste; consistent finish	Natural variation; must be culled	
Versatility**	Suitable options for interior or exterior application	Different grade of material and finish required for outdoor use	

\* Marks denoted by (\*) asterisk are owned by third parties.

· Loctite® PL Premium® is owned by Henkel IP & Holding GmbH.  
· Sherwin-Williams is owned by SWMC, Inc.

\*\* Always consult the local building code authority to determine suitability of products to meet specific requirements, as well as adhesive manufacturer's recommendations for your particular climate and the substrate you are installing to.

\*\*\* Fypon product should be painted within 90 days of installation.

## Finishing Touches

### Primer Color Match Available at Sherwin-Williams

To better service our customers nationwide, we have worked with Sherwin-Williams' to formulate a color and sheen match for our factory-applied primer.

#### Fypon® White:

Resilience® Exterior Latex\*  
Product # K42W51  
Sheen: Flat  
Base: Extra White  
No colorant needs to be added to the formula.

#### Fypon® Oatmeal:

Resilience® Exterior Latex\*  
Product # K43W53  
Sheen: Satin  
Base: Deep Base  
Quart and gallon formulas are shown below.

#### Quart Formula

W1 – White 4/32, 1/64  
B1 – Black 7/32, 1/64, 1/128  
R2 – Maroon 4/32  
Y3 – Deep Gold 15/32, 1/64, 1/128

#### Gallon Formula

W1 – White 18/32  
B1 – Black 31/32, 1/128  
R2 – Maroon 15/32, 1/64  
Y3 – Deep Gold 63/32

#### Fypon® Black Primer:

SHER-WOOD® ACR: Millwork Primer\*  
Product # E60BP102

PART NUMBER	PAGE	DESCRIPTION
20020	56	DOOR TRIM KIT SMOOTH
40020505TK	249	QUICKPOST TRIM KIT WHT
40040404BC	246	QR POST BALL CAP WHT
40040404GC	246	QR POST GOTHIC CAP WHT
40040404NC	246	QR POST NEW ENGLAND CAP WHT
40040404PB	246	QR POST NEW ENGLAND BASE WHT
40040404TC	246	QR POST TAPER CAP WHT
40040505BC	246	QR POST BALL CAP WHT
40040505GC	246	QR POST GOTHIC CAP WHT
40040505NC	246	QR POST NEW ENGLAND CAP WHT
40040505PB	246	QR POST NEW ENGLAND BASE WHT
40040505TC	246	QR POST TAPER CAP WHT
40043305SS	248	QR SQUARE SPINDLE WHT
40043905SS	248	QR SQUARE SPINDLE WHT
40043305CS	248	QR COLONIAL SPINDLE WHT
40050408PS	245	QR POST SLEEVE WHT
40050409PS	245	QR POST SLEEVE WHT
40050438CPK	244	QR COMPLETE POST KIT WHT
40050438PK	244	QR COMPLETE POST KIT WHT
40050438PS	245	QR POST SLEEVE WHT
40050444PK	244	QR COMPLETE POST KIT WHT
40050444PS	245	QR POST SLEEVE WHT
40050448PS	245	QR POST SLEEVE WHT
40050460PS	245	QR POST SLEEVE WHT
40050508PS	245	QR POST SLEEVE WHT
40050509PS	245	QR POST SLEEVE WHT
40050538PS	245	QR POST SLEEVE WHT
40050538PPPS	245	QR POST SLEEVE WHT
40050544PS	245	QR POST SLEEVE WHT
4005ACQHDR	244	QR HARDWARE FOR POST KIT
400600PWTK	249	QUICKPOST TRIM KIT WHT
4007010CBR	248	QR BOTTOM RAIL FOR COLONIAL SPINDLE WHT
4007010SBR	248	QR BOTTOM RAIL FOR SQUARE SPINDLE WHT
4007010SLR	248	QR BOTTOM STAIR RAIL FOR COL/SQR SPINDLE WHT
4007012CBR	248	QR BOTTOM RAIL FOR COLONIAL SPINDLE 141IN WHT
4007012SBR	248	QR BOTTOM RAIL FOR SQUARE SPINDLE 144IN WHT
4007060CBR	248	QR BOTTOM RAIL FOR COLONIAL SPINDLE 70-1/2IN WHT
4007060SBR	248	QR BOTTOM RAIL FOR SQUARE SPINDLE 72IN WHT
4007060SLR	248	QR BOTTOM STAIR RAIL FOR COL/SQR SPINDLE 78IN WHT
4007080CBR	248	QR BOTTOM RAIL FOR COLONIAL SPINDLE 94-1/8IN WHT
4007080SBR	248	QR BOTTOM RAIL FOR SQUARE SPINDLE 96IN WHT
4007080SLR	248	QR BOTTOM STAIR RAIL FOR COL/SQR SPINDLE 102IN WHT
40071000CB	248	QR CRUSH BLOCK WHT
40500488SQ	249	PVC SQUARE QUICKPOST WHT
405004SQTk	249	QUICKPOST TRIM KIT WHT
40500588CL	249	PVC COLONIAL QUICKPOST WHT
40500588SQ	249	PVC SQUARE QUICKPOST WHT
405005SQTk	249	QUICKPOST TRIM KIT WHT
40500688CL	249	PVC COLONIAL QUICKPOST WHT
44020000AB	251	GRAB RAIL INLINE BRACKET
44020000AC	251	GRAB RAIL STRAIGHT CONNECTOR
44020000EC	251	GRAB RAIL END CAPS
44020000EL	251	GRAB RAIL P LOOP RETURN
44020000MB	251	GRAB RAIL MOUNTING BRACKET INSERT
44020005EB	251	GRAB RAIL 5 DEGREE RADIUS ELBOW
44020006AB	251	GRAB RAIL 6 IN OUTSIDE CORNER MTG BRACKET
44020032EB	251	GRAB RAIL 32 DEGREE RADIUS ELBOW

PART NUMBER	PAGE	DESCRIPTION
44020036EB	251	GRAB RAIL 36 DEGREE RADIUS ELBOW
440200900C	251	GRAB RAIL 90 DEGREE OUTSIDE CORNER
44020090PR	251	GRAB RAIL 90 DEGREE ALUM POST RETURN
44020090RE	251	GRAB RAIL 90 DEGREE RADIUS ELBOW
4402038SEB	251	GRAB RAIL 38 DEGREE STAIR ELBOW
44020812GR	251	GRAB RAIL HANDRAIL W/ALUM INSERT
44021212UC	251	GRAB RAIL UNIVERSAL CONNECTOR
44043275CS	248	QR COLONIAL SPINDLE WHT
44043275SS	248	QR SQUARE SPINDLE WHT
44043875SS	248	QR SQUARE SPINDLE WHT
4407010CTR	248	QR TOP RAIL FOR COLONIAL SPINDLE WHT
4407010SSR	248	QR DLX STAIR RAIL COL/SQR SPINDLE WHT
4407010STR	248	QR TOP RAIL FOR SQAURE SPINDLE WHT
4407012CTR	248	QR TOP RAIL FOR COLONIAL SPINDLE WHT
4407012STR	248	QR TOP RAIL FOR SQAURE SPINDLE WHT
44070320SX	248	QUICKRAIL SCREW PACK (QTY-32) WHT
4407040MCB	248	QR BOTTOM RAIL MULTIANGLE CONENCT & PVT BKT WHT
4407040MCT	248	QR TOP RAIL MULTIANGLE CONENCT & PVT BKT WHT
4407060CTR	248	QR TOP RAIL FOR COLONIAL SPINDLE WHT
4407060SSR	248	QR TOP STAIR RAIL COL/SQR SPINDLE WHT
4407060STR	248	QR TOP RAIL FOR SQUARE SPINDLE WHT
4407080CTR	248	QR TOP RAIL FOR COLONIAL SPINDLE WHT
4407080SSR	248	QR TOP STAIR RAIL COL/SQR SPINDLE WHT
4407080STR	248	QR TOP RAIL FOR SQUARE SPINDLE WHT
44070DFMBK	247	QR BRACKET KIT MULTI-ANGLE WHT
440900DCBK	247	QR ADAPTOR KIT CURVED WHT
440900DFBK	247	QR BRACKET KIT STRAIGHT WHT
4409DFSUBK	247	BRACKET KIT STAIR WHT
4436CLDFGK	246	GATE KIT DLX W/COLONIAL SPINDLE WHT
4436SQDFGK	246	GATE KIT DLX W/SQUARE SPINDLE WHT
4442SQDFGK	246	GATE KIT DLX W/SQUARE SPINDLE WHT
4T020505TK	249	QUICKPOST TRIM KIT TAN
4T020606TK	249	QUICKPOST TRIM KIT TAN
4T040404BC	246	QR POST BALL CAP TAN
4T040404GC	246	QR POST GOTHIC CAP TAN
4T040404NC	246	QR POST NEW ENGLAND CAP TAN
4T040404PB	246	QR POST NEW ENGLAND BASE TAN
4T040404TC	246	QR POST TAPER CAP TAN
4T050408PS	245	QR POST SLEEVE TAN
4T050409PS	245	QR POST SLEEVE TAN
4T050438PK	244	QR COMPLETE POST KIT TAN
4T050438PS	245	QR POST SLEEVE TAN
4T050444PK	244	QR COMPLETE POST KIT TAN
4T050444PS	245	QR POST SLEEVE TAN
4T050448PS	245	QR POST SLEEVE TAN
4T050460PS	245	QR POST SLEEVE TAN
4T07010CBR	248	QR BOTTOM RAIL FOR COLONIAL SPINDLE TAN
4T07010SBR	248	QR BOTTOM RAIL FOR SQUARE SPINDLE TAN
4T07010SLR	248	QR BOTTOM STAIR RAIL FOR COL/SQR SPINDLE TAN
4T07012CBR	248	QR BOTTOM RAIL FOR COLONIAL SPINDLE TAN
4T07012SBR	248	QR BOTTOM RAIL FOR SQUARE SPINDLE TAN
4T07060CBR	248	QR BOTTOM RAIL FOR COLONIAL SPINDLE TAN
4T07060SBR	248	QR BOTTOM RAIL FOR SQUARE SPINDLE TAN
4T07060SLR	248	QR BOTTOM STAIR RAIL FOR COL/SQR SPINDLE TAN
4T07080CBR	248	QR BOTTOM RAIL FOR COLONIAL SPINDLE TAN
4T07080SBR	248	QR BOTTOM RAIL FOR SQUARE SPINDLE TAN
4T07080SLR	248	QR BOTTOM STAIR RAIL FOR COL/SQR SPINDLE TAN



PART NUMBER	PAGE	DESCRIPTION
4T071000CB	248	QR CRUSH BLOCK TAN
4T500588CL	249	QR QUICKPOST COLONIAL TAN
4T500688CL	249	QR QUICKPOST COLONIAL TAN
44T36CLDFGK	246	GATE KIT DLX W/COLONIAL SPINDLE TAN
44T36SQDFGK	246	GATE KIT DLX W/SQUARE SPINDLE TAN
44T42SQDFGK	246	GATE KIT DLX W/SQUARE SPINDLE TAN
44T43275CS	248	QR COLONIAL SPINDLE TAN
44T43275SS	248	QR SQUARE SPINDLE TAN
44T43875SS	248	QR SQUARE SPINDLE TAN
44T7010CTR	248	QR TOP RAIL FOR COLONIAL SPINDLE TAN
44T7010SSR	248	QR TOP STAIR RAIL COL/SQR SPINDLE TAN
44T7010STR	248	QR TOP RAIL FOR SQUARE SPINDLE TAN
44T7012CTR	248	QR TOP RAIL FOR COLONIAL SPINDLE TAN
44T7012STR	248	QR TOP RAIL FOR SQUARE SPINDLE TAN
44T70320SX	248	QUICKRAIL SCREW PACK (QTY-32) TAN
44T7040MCB	248	QR BOTTOM RAIL MULTIANGLE CONENCT & PVT BKT TAN
44T7040MCT	248	QR TOP RAIL MULTIANGLE CONENCT & PVT BKT TAN
44T7060CTR	248	QR TOP RAIL FOR COLONIAL SPINDLE TAN
44T7060SSR	248	QR TOP STAIR RAIL COL/SQR SPINDLE TAN
44T7060STR	248	QR TOP RAIL FOR SQUARE SPINDLE TAN
44T7080CTR	248	QR TOP RAIL FOR COLONIAL SPINDLE TAN
44T7080SSR	248	QR TOP STAIR RAIL COL/SQR SPINDLE TAN
44T7080STR	248	QR TOP RAIL FOR SQUARE SPINDLE TAN
44T70DFMBK	247	BRACKET KIT MULTI-ANGLE TAN
44T900DFBK	247	BRACKET KIT STRAIGHT TAN
44T9DFSUBK	247	BRACKET KIT STAIR TAN
70050438CPK	244	QR ULTRAPOST KIT - CONCRETE WHT
70050438WPK	244	QR ULTRAPOST KIT - WOOD/COMP WHT
70050444CPK	244	QR ULTRAPOST KIT - CONCRETE WHT
70050444WPK	244	QR ULTRAPOST KIT - WOOD/COMP WHT
70T50438CPK	244	QR ULTRAPOST KIT - CONCRETE TAN
70T50438WPK	244	QR ULTRAPOST KIT - WOOD/COMP TAN
70T50444CPK	244	QR ULTRAPOST KIT - CONCRETE TAN
70T50444WPK	244	QR ULTRAPOST KIT - WOOD/COMP TAN
740636CLDF	243	QR RAIL KIT DLX W/COLONIAL SPINDLE WHT
740636CLDS	243	QR STAIR KIT DLX W/COLONIAL SPINDLE WHT
740636SQDF	243	QR RAIL KIT DLX W/SQUARE SPINDLE WHT
740636SQDS	243	QR STAIR KIT DLX W/SQUARE SPINDLE WHT
740642SQDF	243	QR RAIL KIT DLX W/SQUARE SPINDLE WHT
740642SQDS	243	QR STAIR KIT DLX W/SQUARE SPINDLE WHT
74070FFPBK	247	ADAPTOR KIT 45 DEG CORNER WHT
740836CLDF	243	QR RAIL KIT DLX W/COLONIAL SPINDLE WHT
740836CLDS	243	QR STAIR KIT DLX W/COLONIAL SPINDLE WHT
740836SQDF	243	QR RAIL KIT DLX W/SQUARE SPINDLE WHT
740836SQDS	243	QR STAIR KIT DLX W/SQUARE SPINDLE WHT
740842SQDF	243	QR RAIL KIT DLX W/SQUARE SPINDLE WHT
740842SQDS	243	QR STAIR KIT DLX W/SQUARE SPINDLE WHT
741036CLDF	243	QR RAIL KIT DLX W/COLONIAL SPINDLE WHT
741036CLDS	243	QR STAIR KIT DLX W/COLONIAL SPINDLE WHT
741036SQDF	243	QR RAIL KIT DLX W/SQUARE SPINDLE WHT
741036SQDS	243	QR STAIR KIT DLX W/SQUARE SPINDLE WHT
741042SQDF	243	QR RAIL KIT DLX W/SQUARE SPINDLE WHT
741042SQDS	243	QR STAIR KIT DLX W/SQUARE SPINDLE WHT
741236CLDF	243	QR RAIL KIT DLX W/COLONIAL SPINDLE WHT
741236SQDF	243	QR RAIL KIT DLX W/SQUARE SPINDLE WHT
741242SQDF	243	QR RAIL KIT DLX W/SQUARE SPINDLE WHT
74T1036CLDF	243	QR RAIL KIT DLX W/COLONIAL SPINDLE TAN

PART NUMBER	PAGE	DESCRIPTION
74T1036CLDS	243	QR STAIR KIT DLX W/COLONIAL SPINDLE TAN
74T1036SQDF	243	QR RAIL KIT DLX W/SQUARE SPINDLE TAN
74T1036SQDS	243	QR STAIR KIT DLX W/SQUARE SPINDLE TAN
74T1042SQDF	243	QR RAIL KIT DLX W/SQUARE SPINDLE TAN
74T1042SQDS	243	QR STAIR KIT DLX W/SQUARE SPINDLE TAN
74T1236CLDF	243	QR RAIL KIT DLX W/COLONIAL SPINDLE TAN
74T1236SQDF	243	QR RAIL KIT DLX W/SQUARE SPINDLE TAN
74T1242SQDF	243	QR RAIL KIT DLX W/SQUARE SPINDLE TAN
74T636CLDF	243	QR RAIL KIT DLX W/COLONIAL SPINDLE TAN
74T636CLDS	243	QR STAIR KIT DLX W/COLONIAL SPINDLE TAN
74T636SQDF	243	QR RAIL KIT DLX W/SQUARE SPINDLE TAN
74T636SQDS	243	QR STAIR KIT DLX W/SQUARE SPINDLE TAN
74T642SQDF	243	QR RAIL KIT DLX W/SQUARE SPINDLE TAN
74T642SQDS	243	QR STAIR KIT DLX W/SQUARE SPINDLE TAN
74T700DCBK	247	ADAPTOR KIT CURVED TAN
74T70FFPBK	247	ADAPTOR KIT 45 DEG CORNER TAN
74T836CLDF	243	QR RAIL KIT DLX W/COLONIAL SPINDLE TAN
74T836CLDS	243	QR STAIR KIT DLX W/COLONIAL SPINDLE TAN
74T836SQDF	243	QR RAIL KIT DLX W/SQUARE SPINDLE TAN
74T836SQDS	243	QR STAIR KIT DLX W/SQUARE SPINDLE TAN
74T842SQDF	243	QR RAIL KIT DLX W/SQUARE SPINDLE TAN
74T842SQDS	243	QR STAIR KIT DLX W/SQUARE SPINDLE TAN
80500588CL	250	DURAPOLY COLONIAL POST 5"X 5"
80500688CL	250	DURAPOLY COLONIAL POST 6"X 6"
800500PWTK	250	DURAPOLY POST TRIM KIT 5"
800600PWTK	250	DURAPOLY POST TRIM KIT 6"
A		
ADH1	252	ADHESIVE PL PREMIUM CARTRIDGE
AFR10	165	FINIAL ACORN FULL ROUND SMOOTH
AP56	40	PEDIMENT ACORN SMOOTH
AP61	40	PEDIMENT ACORN SMOOTH
AP86	40	PEDIMENT ACORN SMOOTH
AP91	40	PEDIMENT ACORN SMOOTH
AP98	40	PEDIMENT ACORN SMOOTH
AP115	40	PEDIMENT ACORN ADJ SMOOTH
AP667	40	PEDIMENT ACORN SMOOTH
AR24X4F	49	TRIM HALF ROUND ARCH FLAT SMOOTH
AR36X10MC	50	TRIM HALF RND ARCH DECO W/END CAP SMOOTH
AR36X10MFL108	51	TRIM HALF RND ARCH DECO W/FLANK SMOOTH
AR36X10SK	42	PEDIMENT HALF RND SNBST W/T & KEY SMOOTH
AR36X4F	49	TRIM HALF ROUND ARCH FLAT SMOOTH
AR36X4M	49	TRIM HALF ROUND ARCH DECORATIVE SMOOTH
AR36X6F	50	TRIM HALF ROUND ARCH FLAT SMOOTH
AR36X6M	50	TRIM HALF ROUND ARCH DECORATIVE SMOOTH
AR37X4F	49	TRIM HALF ROUND ARCH FLAT SMOOTH
AR40X54PSK	42	PEDIMENT HALF RND SNBST W/T & KEY SMOOTH
AR40X6M	50	TRIM HALF ROUND ARCH DECORATIVE SMOOTH
AR48X4F	49	TRIM HALF ROUND ARCH FLAT SMOOTH
AR48X4M	49	TRIM HALF ROUND ARCH DECORATIVE SMOOTH
AR48X6F	50	TRIM HALF ROUND ARCH FLAT SMOOTH
AR48X6M	50	TRIM HALF ROUND ARCH DECORATIVE SMOOTH
AR60X6M	50	TRIM HALF ROUND ARCH DECORATIVE SMOOTH
AR64X10MC	50	TRIM HALF RND ARCH DECO W/END CAP SMOOTH
AR72X4F	49	TRIM HALF ROUND ARCH FLAT SMOOTH
AR72X6M	50	TRIM HALF ROUND ARCH DECORATIVE SMOOTH
B		
B3X4	165	FINIAL BALL SMOOTH

PART NUMBER	PAGE	DESCRIPTION
B3X5	165	FINIAL BALL SMOOTH
B4X6	165	FINIAL BALL SMOOTH
B5X7	165,216	NEWEL POST BALL SMOOTH
B6X8	165	FINIAL BALL SMOOTH
B6X9	165	FINIAL BALL SMOOTH
B7X9	165	FINIAL BALL SMOOTH
B8X10	165	FINIAL BALL SMOOTH
B10X13	165,216	NEWEL POST BALL SMOOTH
B12X16	165	FINIAL BALL SMOOTH
BAL2X20SQ	208	BALUSTER SQUARE SMOOTH
BAL2X24SQ	208	BALUSTER SQUARE SMOOTH
BAL2X28SQ	208	BALUSTER SQUARE SMOOTH
BAL2X32SQ	208	BALUSTER SQUARE SMOOTH
BAL2.5X15AY	203	BALUSTER ASHLEY SMOOTH
BAL3X18WF	207	BALUSTER WOODRUFF SMOOTH
BAL3X20AY	203	BALUSTER ASHLEY SMOOTH
BAL3X20CC	205	BALUSTER CLASSIC SMOOTH
BAL3X20WF	207	BALUSTER WOODRUFF SMOOTH
BAL3X24AY	203	BALUSTER ASHLEY SMOOTH
BAL3X24CC	205	BALUSTER CLASSIC SMOOTH
BAL3X24LN	206	BALUSTER LOGAN SMOOTH
BAL3X24WF	207	BALUSTER WOODRUFF SMOOTH
BAL3X28AY	203	BALUSTER ASHLEY SMOOTH
BAL3X28CC	205	BALUSTER CLASSIC SMOOTH
BAL3X28LN	206	BALUSTER LOGAN SMOOTH
BAL3X28WF	207	BALUSTER WOODRUFF SMOOTH
BAL3X32AY	203	BALUSTER ASHLEY SMOOTH
BAL3X32CC	205	BALUSTER CLASSIC SMOOTH
BAL3X32WF	207	BALUSTER WOODRUFF SMOOTH
BAL3X36AY	203	BALUSTER ASHLEY SMOOTH
BAL3X36WF	207	BALUSTER WOODRUFF SMOOTH
BAL4X22BE	204	BALUSTER BEAUMONT SMOOTH
BAL4X24AY	203	BALUSTER ASHLEY SMOOTH
BAL4X27CCOB	205	BALUSTER CLASSIC SMOOTH
BAL4X31CCOB	205	BALUSTER CLASSIC SMOOTH
BAL5X19BE	204	BALUSTER BEAUMONT SMOOTH
BAL5X20CC	205	BALUSTER CLASSIC SMOOTH
BAL5X20RL	206	BALUSTER ROSEDALE SMOOTH
BAL5X22BE	204	BALUSTER BEAUMONT SMOOTH
BAL5X24AY	203	BALUSTER ASHLEY SMOOTH
BAL5X24CC	205	BALUSTER CLASSIC SMOOTH
BAL5X24WF	207	BALUSTER WOODRUFF SMOOTH
BAL5X28CC	205	BALUSTER CLASSIC SMOOTH
BAL5X28CCOB	205	BALUSTER CLASSIC SMOOTH
BAL5X28EUST	222	BALUSTER, STONE TEXTURE, EUROSTYLE
BAL5X28WF	207	BALUSTER WOODRUFF SMOOTH
BAL5X30CC	205	BALUSTER CLASSIC SMOOTH
BAL5X31BE	204	BALUSTER BEAUMONT SMOOTH
BAL5X32AY	203	BALUSTER ASHLEY SMOOTH
BAL5X32CC	205	BALUSTER CLASSIC SMOOTH
BAL5X32WF	207	BALUSTER WOODRUFF SMOOTH
BAL6X22BE	204	BALUSTER BEAUMONT SMOOTH
BAL7X28CC	205	BALUSTER CLASSIC SMOOTH
BAL7X28CCOB	205	BALUSTER CLASSIC SMOOTH
BBR5X96	211	BALUSTER STRAIGHT BOTTOM RAIL SMOOTH
BBR5X144	211	BALUSTER STRAIGHT BOTTOM RAIL SMOOTH
BBR6X96ST	222	BALUSTER BOTTOM RAIL, STONE TEXTURE

PART NUMBER	PAGE	DESCRIPTION
BBR7X96	211	BALUSTER STRAIGHT BOTTOM RAIL SMOOTH
BBR7X120	211	BALUSTER STRAIGHT BOTTOM RAIL SMOOTH
BBR7X144	211	BALUSTER STRAIGHT BOTTOM RAIL SMOOTH
BBR12X96	211	BALUSTER STRAIGHT BOTTOM RAIL SMOOTH
BBR12X120	211	BALUSTER STRAIGHT BOTTOM RAIL SMOOTH
BBR12X144	211	BALUSTER STRAIGHT BOTTOM RAIL SMOOTH
BC10X15	176	BEAM CAP, TIMBER TEXTURE
BKT4X18X4	130	BRACKET SMOOTH
BKT5X4	134	BRACKET SMOOTH
BKT5X5X9	136	BRACKET SMOOTH
BKT5X8X6	130	BRACKET SMOOTH
BKT5X10	130	BRACKET SMOOTH
BKT5X20	129	BRACKET SMOOTH
BKT6X8	127	BRACKET SMOOTH
BKT6X24	129	BRACKET SMOOTH
BKT6X24X6	130	BRACKET SMOOTH
BKT7X6X12	136	BRACKET SMOOTH
BKT7X11X3	127	BRACKET SMOOTH
BKT7X12X4	128	BRACKET SMOOTH
BKT7X16	139	BRACKET SMOOTH
BKT7X18	139	BRACKET SMOOTH
BKT8X6	127	BRACKET SMOOTH
BKT8X7X18	136	BRACKET SMOOTH
BKT8X8	127	BRACKET SMOOTH
BKT8X8X4	127	BRACKET SMOOTH
BKT8X9X14	136	BRACKET SMOOTH
BKT8X13	128	BRACKET SMOOTH
BKT8X15	130	BRACKET SMOOTH
BKT8X17	139	BRACKET SMOOTH
BKT8X29X4	140	BRACKET SMOOTH
BKT9X11	122	BRACKET SMOOTH
BKT9X13	130	BRACKET SMOOTH
BKT10X16	133	BRACKET SMOOTH
BKT11X15	130	BRACKET SMOOTH
BKT11X16X6	139	BRACKET SMOOTH
BKT11X30	134	BRACKET SMOOTH
BKT10X10X9	127	BRACKET SMOOTH
BKT10X11	127	BRACKET SMOOTH
BKT10X12	134	BRACKET SMOOTH
BKT10X12X4	128	BRACKET SMOOTH
BKT10X14	139	BRACKET SMOOTH
BKT10X16X4	122	BRACKET SMOOTH
BKT11X12X3	140	BRACKET SMOOTH
BKT11X16	130	BRACKET SMOOTH
BKT11X17	133	BRACKET SMOOTH
BKT11X20	122	BRACKET SMOOTH
BKT11X20X6	139	BRACKET SMOOTH
BKT11X20X8	138	BRACKET SMOOTH
BKT12X10	128	BRACKET SMOOTH
BKT12X12	133	BRACKET SMOOTH
BKT12X12X3	134	BRACKET SMOOTH
BKT12X12X4	122	BRACKET SMOOTH
BKT12X12GP	133	BRACKET SMOOTH
BKT12X12WW	134	BRACKET SMOOTH
BKT12X16	122	BRACKET SMOOTH
BKT12X17	133	BRACKET SMOOTH
BKT12X18X3X1S	148	BRACKET, TIMBER TEXTURE

PART NUMBER	PAGE	DESCRIPTION
BKT12X20X3S	150	BRACKET, TIMBER TEXTURE
BKT12X21X3	134	BRACKET SMOOTH
BKT12X24X3	123	BRACKET SMOOTH
BKT12X24X3S	151	BRACKET, TIMBER TEXTURE
BKT13X6	136	BRACKET SMOOTH
BKT13X13X3	129	BRACKET SMOOTH
BKT13X15	140	BRACKET SMOOTH
BKT13X18X8S	148	BRACKET, TIMBER TEXTURE
BKT14X30X7.5S	150	BRACKET, TIMBER TEXTURE
BKT14X14	140	BRACKET SMOOTH
BKT14X15	134	BRACKET SMOOTH
BKT14X16	128	BRACKET SMOOTH
BKT14X26	139	BRACKET SMOOTH
BKT14X16X3.5S	148	BRACKET, TIMBER TEXTURE
BKT14X16X4	122	BRACKET SMOOTH
BKT14X16X6S	148	BRACKET, TIMBER TEXTURE
BKT15X15	140	BRACKET SMOOTH
BKT15X18X6	124	BRACKET SMOOTH
BKT15X28	133	BRACKET SMOOTH
BKT16X9	139	BRACKET SMOOTH
BKT16X16	122	BRACKET SMOOTH
BKT16X18X3	122	BRACKET SMOOTH
BKT16X18X4S	148	BRACKET, TIMBER TEXTURE
BKT16X23X3	134	BRACKET SMOOTH
BKT16X32X4S	150	BRACKET, TIMBER TEXTURE
BKT17X17	122	BRACKET SMOOTH
BKT18X30X4	123	BRACKET SMOOTH
BKT18X9X3	128	BRACKET SMOOTH
BKT18X10	128	BRACKET SMOOTH
BKT18X18X3X1S	148	BRACKET, TIMBER TEXTURE
BKT18X18X4	122	BRACKET SMOOTH
BKT18X24X3X2S	150	BRACKET, TIMBER TEXTURE
BKT18X24X3	129	BRACKET SMOOTH
BKT18X24X4	123	BRACKET SMOOTH
BKT18X35	138	BRACKET SMOOTH
BKT19X20	134	BRACKET SMOOTH
BKT19X24X4	124	BRACKET SMOOTH
BKT19X31	124	BRACKET SMOOTH
BKT19X36X4	124	BRACKET SMOOTH
BKT20X24X5	124	BRACKET SMOOTH
BKT20X30X6	123	BRACKET SMOOTH
BKT22X21	134	BRACKET SMOOTH
BKT22X22	140	BRACKET SMOOTH
BKT22X24X4S-1	148	BRACKET, TIMBER TEXTURE
BKT22X24X6S	148	BRACKET, TIMBER TEXTURE
BKT22X26	129	BRACKET SMOOTH
BKT22X30	133	BRACKET SMOOTH
BKT22X30X6S	151	BRACKET, TIMBER TEXTURE
BKT22X30X8S	150	BRACKET, TIMBER TEXTURE
BKT23X26	138	BRACKET SMOOTH
BKT24X12	139	BRACKET SMOOTH
BKT24X18X4S	148	BRACKET, TIMBER TEXTURE
BKT24X24X5	133	BRACKET SMOOTH
BKT24X24X12	128	BRACKET SMOOTH
BKT24X36	124	BRACKET SMOOTH
BKT25X25	124	BRACKET SMOOTH
BKT25X27	123	BRACKET SMOOTH

PART NUMBER	PAGE	DESCRIPTION
BKT26X24X4S	148	BRACKET, TIMBER TEXTURE
BKT26X24X6S	148	BRACKET, TIMBER TEXTURE
BKT26X28	140	BRACKET SMOOTH
BKT28X30	124	BRACKET SMOOTH
BKT30X30	124	BRACKET SMOOTH
BKT30X30X8	140	BRACKET SMOOTH
BKT31X30X5	124	BRACKET SMOOTH
BKT32X32	123	BRACKET SMOOTH
BKT32X31X5	160	TRELLIS OUTLOOKER SMOOTH
BKT32X31X5S	161	BRACKET, TIMBER TEXTURE
BKT36X36X4	123	BRACKET SMOOTH
BKT36X36X6	123	BRACKET SMOOTH
BKT36X36	124	BRACKET SMOOTH
BKT36X42	127	BRACKET SMOOTH
BKT40X40	123	BRACKET SMOOTH
BKTCV18X24X4S	151	BRACKET, TIMBER TEXTURE, COVE KNEE BRACE
BKTCV18X24X6S	151	BRACKET, TIMBER TEXTURE, COVE KNEE BRACE
BKTCV21X30X4S	151	BRACKET, TIMBER TEXTURE, COVE KNEE BRACE
BKTCV21X30X6S	151	BRACKET, TIMBER TEXTURE, COVE KNEE BRACE
BKTS18X24X6S	151	BRACKET, TIMBER TEXTURE, STRAIGHT KNEE BRACE
BMD4X8X48S	161	BEAM, TIMBER TEXTURE
BM4X5X192	167	BEAM SMOOTH
BM4X5X192S	178	BRACKET, TIMBER TEXTURE
BMCDR4X3X168S	179	BEAM, TIMBER TEXTURE
BMCDR8X6X168S	179	BEAM, TIMBER TEXTURE
BMCRT25X12X6S	147	BEAM, TIMBER TEXTURE, RAFTER TAIL
BMD4X8X144	160	TRELLIS BEAM SMOOTH
BMD4X8X48	160	TRELLIS BEAM SMOOTH
BMD4X8X144S	161	BEAM, TIMBER TEXTURE
BEAM HAND HEWN		
BMH4X6X96ELM	169	BEAM HAND HEWN, ELM
BMH4X6X144ELM	169	BEAM HAND HEWN, ELM
BMH4X6X192ELM	169	BEAM HAND HEWN, ELM
BMH4X6X240ELM	169	BEAM HAND HEWN, ELM
BMH4X6X288ELM	169	BEAM HAND HEWN, ELM
BMH6X8X96ELM	169	BEAM HAND HEWN, ELM
BMH6X8X144ELM	169	BEAM HAND HEWN, ELM
BMH6X8X192ELM	169	BEAM HAND HEWN, ELM
BMH6X8X240ELM	169	BEAM HAND HEWN, ELM
BMH6X8X288ELM	169	BEAM HAND HEWN, ELM
BMH8X10X96ELM	169	BEAM HAND HEWN, ELM
BMH8X10X144ELM	169	BEAM HAND HEWN, ELM
BMH8X10X192ELM	169	BEAM HAND HEWN, ELM
BMH8X10X240ELM	169	BEAM HAND HEWN, ELM
BMH8X10X288ELM	169	BEAM HAND HEWN, ELM
BMH6X8X60ELM-EC	168	BEAM MANTEL HAND HEWN 6" X 8" 60"
BMH6X8X66ELM-EC	168	BEAM MANTEL HAND HEWN 6" X 8" 66"
BMH6X8X72ELM-EC	168	BEAM MANTEL HAND HEWN 6" X 8" 72"
BMH6X8X78ELM-EC	168	BEAM MANTEL HAND HEWN 6" X 8" 78"
BMH6X8X84ELM-EC	168	BEAM MANTEL HAND HEWN 6" X 8" 84"
BMH6X8X90ELM-EC	168	BEAM MANTEL HAND HEWN 6" X 8" 90"
BMH8X10X60ELM-EC	168	BEAM MANTEL HAND HEWN 8" X 10" 60"
BMH8X10X66ELM-EC	168	BEAM MANTEL HAND HEWN 8" X 10" 66"
BMH8X10X72ELM-EC	168	BEAM MANTEL HAND HEWN 8" X 10" 72"
BMH8X10X78ELM-EC	168	BEAM MANTEL HAND HEWN 8" X 10" 78"
BMH8X10X84ELM-EC	168	BEAM MANTEL HAND HEWN 8" X 10" 84"
BMH8X10X90ELM-EC	168	BEAM MANTEL HAND HEWN 8" X 10" 90"

PART NUMBER	PAGE	DESCRIPTION
BEAM MESA		
BMM4X6X96RDW	170	BEAM MESA, REDWOOD
BMM4X6X144RDW	170	BEAM MESA, REDWOOD
BMM4X6X192RDW	170	BEAM MESA, REDWOOD
BMM4X6X240RDW	170	BEAM MESA, REDWOOD
BMM4X6X288RDW	170	BEAM MESA, REDWOOD
BMM6X8X96RDW	170	BEAM MESA, REDWOOD
BMM6X8X144RDW	170	BEAM MESA, REDWOOD
BMM6X8X192RDW	170	BEAM MESA, REDWOOD
BMM6X8X240RDW	170	BEAM MESA, REDWOOD
BMM6X8X288RDW	170	BEAM MESA, REDWOOD
BMM8X10X96RDW	170	BEAM MESA, REDWOOD
BMM8X10X144RDW	170	BEAM MESA, REDWOOD
BMM8X10X192RDW	170	BEAM MESA, REDWOOD
BMM8X10X240RDW	170	BEAM MESA, REDWOOD
BMM8X10X288RDW	170	BEAM MESA, REDWOOD
BMM10X15X234RDW	170	BEAM MESA, REDWOOD
BMPLTHDWKT10	178	BEAM PLATE HARDWARE KIT, QTY 10
BMPLTHDWKT20	178	BEAM PLATE HARDWARE KIT, QTY 20
BMPLTHDWKT40	178	BEAM PLATE HARDWARE KIT, QTY 40
BMPH10X15	176	BEAM PLATE HAMMERED
BMPH15X20	176	BEAM PLATE HAMMERED
BMPH36X36	176	BEAM PLATE HAMMERED
BMPH48X48	176	BEAM PLATE HAMMERED
BMPH6X10	219	BEAM PLATE HAMMERED
BMPH8X10	176	BEAM PLATE HAMMERED
BMPTS10X15	176	BEAM PLATE SMOOTH
BMPTS15X20	176	BEAM PLATE SMOOTH
BMPTS36X36	176	BEAM PLATE SMOOTH
BMPTS48X48	176	BEAM PLATE SMOOTH
BMPTS6X10	176	BEAM PLATE SMOOTH
BMPTS8X10	176	BEAM PLATE SMOOTH
BMR4X6X96CDR	172	BEAM ROUGH SAWN, WESTERN RED CEDAR
BMR4X6X144CDR	172	BEAM ROUGH SAWN, WESTERN RED CEDAR
BMR4X6X192CDR	172	BEAM ROUGH SAWN, WESTERN RED CEDAR
BMR4X6X240CDR	172	BEAM ROUGH SAWN, WESTERN RED CEDAR
BMR4X6X288CDR	172	BEAM ROUGH SAWN, WESTERN RED CEDAR
BMR6X8X96CDR	172	BEAM ROUGH SAWN, WESTERN RED CEDAR
BMR6X8X144CDR	172	BEAM ROUGH SAWN, WESTERN RED CEDAR
BMR6X8X192CDR	172	BEAM ROUGH SAWN, WESTERN RED CEDAR
BMR6X8X240CDR	172	BEAM ROUGH SAWN, WESTERN RED CEDAR
BMR6X8X288CDR	172	BEAM ROUGH SAWN, WESTERN RED CEDAR
BMR8X10X96CDR	172	BEAM ROUGH SAWN, WESTERN RED CEDAR
BMR8X10X144CDR	172	BEAM ROUGH SAWN, WESTERN RED CEDAR
BMR8X10X192CDR	172	BEAM ROUGH SAWN, WESTERN RED CEDAR
BMR8X10X240CDR	172	BEAM ROUGH SAWN, WESTERN RED CEDAR
BMR8X10X288CDR	172	BEAM ROUGH SAWN, WESTERN RED CEDAR
BMR6X8X60CDR-EC	168	BEAM MANTEL ROUGH SAWN 6" X 8" 60"
BMR6X8X66CRR-EC	168	BEAM MANTEL ROUGH SAWN 6" X 8" 66"
BMR6X8X72CDR-EC	168	BEAM MANTEL ROUGH SAWN 6" X 8" 72"
BMR6X8X78CDR-EC	168	BEAM MANTEL ROUGH SAWN 6" X 8" 78"
BMR6X8X84CDR-EC	168	BEAM MANTEL ROUGH SAWN 6" X 8" 84"
BMR6X8X90CDR-EC	168	BEAM MANTEL ROUGH SAWN 6" X 8" 90"
BMR8X10X60CDR-EC	168	BEAM MANTEL ROUGH SAWN 8" X 10" 60"
BMR8X10X66CDR-EC	168	BEAM MANTEL ROUGH SAWN 8" X 10" 66"
BMR8X10X72CDR-EC	168	BEAM MANTEL ROUGH SAWN 8" X 10" 72"
BMR8X10X78CDR-EC	168	BEAM MANTEL ROUGH SAWN 8" X 10" 78"

PART NUMBER	PAGE	DESCRIPTION
BMR8X10X84CDR-EC	168	BEAM MANTEL ROUGH SAWN 8" X 10" 84"
BMR8X10X90CDR-EC	168	BEAM MANTEL ROUGH SAWN 8" X 10" 90"
BMRTS6X6X12S	147	BEAM RAFTER TAIL, TIMBER TEXTURE
BMRT4X8X42S	147	BEAM RAFTER TAIL, TIMBER TEXTURE
BMRTS6X4X24S	147	BEAM RAFTER TAIL, TIMBER TEXTURE
BMRTS8X4X24S	147	BEAM RAFTER TAIL, TIMBER TEXTURE
BMRTBL4X6X12RS-4PK	146	BEAM RAFTER TAIL, ROUGH SAWN, BULL NOSE
BMRTBL4X6X12RSP4-4PK	146	BEAM RAFTER TAIL, ROUGH SAWN, BULL NOSE
BMRTBL4X6X12RSP6-4PK	146	BEAM RAFTER TAIL, ROUGH SAWN, BULL NOSE
BMRTBL4X6X12RSP8-4PK	146	BEAM RAFTER TAIL, ROUGH SAWN, BULL NOSE
BMRTBL4X6X12RSP10-4PK	146	BEAM RAFTER TAIL, ROUGH SAWN, BULL NOSE
BMRTBL4X6X12RSP12-4PK	146	BEAM RAFTER TAIL, ROUGH SAWN, BULL NOSE
BMRTBL4X6X12RS-10PK	146	BEAM RAFTER TAIL, ROUGH SAWN, BULL NOSE
BMRTBL4X6X12RSP4-10PK	146	BEAM RAFTER TAIL, ROUGH SAWN, BULL NOSE
BMRTBL4X6X12RSP6-10PK	146	BEAM RAFTER TAIL, ROUGH SAWN, BULL NOSE
BMRTBL4X6X12RSP8-10PK	146	BEAM RAFTER TAIL, ROUGH SAWN, BULL NOSE
BMRTBL4X6X12RSP10-10PK	146	BEAM RAFTER TAIL, ROUGH SAWN, BULL NOSE
BMRTBL4X6X12RSP12-10PK	146	BEAM RAFTER TAIL, ROUGH SAWN, BULL NOSE
BMRTBL4X6X18RS-4PK	146	BEAM RAFTER TAIL, ROUGH SAWN, BULL NOSE
BMRTBL4X6X18RSP4-4PK	146	BEAM RAFTER TAIL, ROUGH SAWN, BULL NOSE
BMRTBL4X6X18RSP6-4PK	146	BEAM RAFTER TAIL, ROUGH SAWN, BULL NOSE
BMRTBL4X6X18RSP8-4PK	146	BEAM RAFTER TAIL, ROUGH SAWN, BULL NOSE
BMRTBL4X6X18RSP10-4PK	146	BEAM RAFTER TAIL, ROUGH SAWN, BULL NOSE
BMRTBL4X6X18RSP12-4PK	146	BEAM RAFTER TAIL, ROUGH SAWN, BULL NOSE
BMRTBL4X6X18RS-10PK	146	BEAM RAFTER TAIL, ROUGH SAWN, BULL NOSE
BMRTBL4X6X18RSP4-10PK	146	BEAM RAFTER TAIL, ROUGH SAWN, BULL NOSE
BMRTBL4X6X18RSP6-10PK	146	BEAM RAFTER TAIL, ROUGH SAWN, BULL NOSE
BMRTBL4X6X18RSP8-10PK	146	BEAM RAFTER TAIL, ROUGH SAWN, BULL NOSE
BMRTBL4X6X18RSP10-10PK	146	BEAM RAFTER TAIL, ROUGH SAWN, BULL NOSE
BMRTBL4X6X18RSP12-10PK	146	BEAM RAFTER TAIL, ROUGH SAWN, BULL NOSE
BMRTBL4X6X24RS-4PK	146	BEAM RAFTER TAIL, ROUGH SAWN, BULL NOSE
BMRTBL4X6X24RSP4-4PK	146	BEAM RAFTER TAIL, ROUGH SAWN, BULL NOSE
BMRTBL4X6X24RSP6-4PK	146	BEAM RAFTER TAIL, ROUGH SAWN, BULL NOSE
BMRTBL4X6X24RSP8-4PK	146	BEAM RAFTER TAIL, ROUGH SAWN, BULL NOSE
BMRTBL4X6X24RSP10-4PK	146	BEAM RAFTER TAIL, ROUGH SAWN, BULL NOSE
BMRTBL4X6X24RSP12-4PK	146	BEAM RAFTER TAIL, ROUGH SAWN, BULL NOSE
BMRTBL4X6X24RS-10PK	146	BEAM RAFTER TAIL, ROUGH SAWN, BULL NOSE
BMRTBL4X6X24RSP4-10PK	146	BEAM RAFTER TAIL, ROUGH SAWN, BULL NOSE
BMRTBL4X6X24RSP6-10PK	146	BEAM RAFTER TAIL, ROUGH SAWN, BULL NOSE
BMRTBL4X6X24RSP8-10PK	146	BEAM RAFTER TAIL, ROUGH SAWN, BULL NOSE
BMRTBL4X6X24RSP10-10PK	146	BEAM RAFTER TAIL, ROUGH SAWN, BULL NOSE
BMRTBL4X6X24RSP12-10PK	146	BEAM RAFTER TAIL, ROUGH SAWN, BULL NOSE
BMRTBL4X6X30RS-4PK	146	BEAM RAFTER TAIL, ROUGH SAWN, BULL NOSE
BMRTBL4X6X30RSP4-4PK	146	BEAM RAFTER TAIL, ROUGH SAWN, BULL NOSE
BMRTBL4X6X30RSP6-4PK	146	BEAM RAFTER TAIL, ROUGH SAWN, BULL NOSE
BMRTBL4X6X30RSP8-4PK	146	BEAM RAFTER TAIL, ROUGH SAWN, BULL NOSE
BMRTBL4X6X30RSP10-4PK	146	BEAM RAFTER TAIL, ROUGH SAWN, BULL NOSE
BMRTBL4X6X30RSP12-4PK	146	BEAM RAFTER TAIL, ROUGH SAWN, BULL NOSE
BMRTBL4X6X36RS-4PK	146	BEAM RAFTER TAIL, ROUGH SAWN, BULL NOSE
BMRTBL4X6X36RSP4-4PK	146	BEAM RAFTER TAIL, ROUGH SAWN, BULL NOSE
BMRTBL4X6X36RSP6-4PK	146	BEAM RAFTER TAIL, ROUGH SAWN, BULL NOSE
BMRTBL4X6X36RSP8-4PK	146	BEAM RAFTER TAIL, ROUGH SAWN, BULL NOSE
BMRTBL4X6X36RSP10-4PK	146	BEAM RAFTER TAIL, ROUGH SAWN, BULL NOSE
BMRTBL4X6X36RSP12-4PK	146	BEAM RAFTER TAIL, ROUGH SAWN, BULL NOSE
BMRTBL4X6X42RS-4PK	146	BEAM RAFTER TAIL, ROUGH SAWN, BULL NOSE
BMRTBL4X6X42RSP4-4PK	146	BEAM RAFTER TAIL, ROUGH SAWN, BULL NOSE
BMRTBL4X6X42RSP6-4PK	146	BEAM RAFTER TAIL, ROUGH SAWN, BULL NOSE









PART NUMBER	PAGE	DESCRIPTION
BMT8X10X192CDR	174	BEAM TAHOE, WESTERN RED CEDAR
BMT8X10X240CDR	174	BEAM TAHOE, WESTERN RED CEDAR
BMT8X10X288CDR	174	BEAM TAHOE, WESTERN RED CEDAR
BTM6X144	176	BEAM TOP MESA
BTM8X144	176	BEAM TOP MESA
BRK5	212	BALUSTER RAIL INSTALL KIT
BRK6-7	212	BALUSTER RAIL INSTALL KIT
BRK12	212	BALUSTER RAIL INSTALL KIT
BRK12ANGLBKT	212	BALUSTER RAIL INSTALL KIT
BTR5X96	210	BALUSTER STRAIGHT TOP RAIL SMOOTH
BTR5X144	210	BALUSTER STRAIGHT TOP RAIL SMOOTH
BTR6X96ST	222	BALUSTER TOP RAIL, STONE TEXTURE
BTR7X96	210	BALUSTER STRAIGHT TOP RAIL SMOOTH
BTR7X120	210	BALUSTER STRAIGHT TOP RAIL SMOOTH
BTR7X144	210	BALUSTER STRAIGHT TOP RAIL SMOOTH
BTR12X96	211	BALUSTER STRAIGHT TOP RAIL SMOOTH
BTR12X120	211	BALUSTER STRAIGHT TOP RAIL SMOOTH
BTR12X144	211	BALUSTER STRAIGHT TOP RAIL SMOOTH
<b>C</b>		
CAP47E	40	PEDIMENT COMBO ECO ACORN SMOOTH
CAP50	40	PEDIMENT COMBO ACORN SMOOTH
CAP50BT	40	PEDIMENT COMBO ACORN W/BT SMOOTH
CAP54	40	PEDIMENT COMBO ACORN SMOOTH
CAP54BT	40	PEDIMENT COMBO ACORN W/BT SMOOTH
CAP58	40	PEDIMENT COMBO ACORN SMOOTH
CAP58BT	40	PEDIMENT COMBO ACORN W/BT SMOOTH
CAP67	40	PEDIMENT COMBO ACORN SMOOTH
CAP67BT	40	PEDIMENT COMBO ACORN W/BT SMOOTH
CAP75	40	PEDIMENT COMBO ACORN SMOOTH
CAP75BT	40	PEDIMENT COMBO ACORN W/BT SMOOTH
CAP80	40	PEDIMENT COMBO ACORN SMOOTH
CAP80BT	40	PEDIMENT COMBO ACORN W/BT SMOOTH
CAP85	40	PEDIMENT COMBO ACORN SMOOTH
CAP85BT	40	PEDIMENT COMBO ACORN W/BT SMOOTH
<b>10" CROSSHEAD</b>		
CCA32X10	30	CROSSHEAD SMOOTH
CCA32X10D	30	CROSSHEAD W/DT SMOOTH
CCA32X10K	30	CROSSHEAD W/KEY SMOOTH
CCA32X10T	30	CROSSHEAD W/TS SMOOTH
CCA32X11BT	30	CROSSHEAD W/BT SMOOTH
CCA34X10	30	CROSSHEAD SMOOTH
CCA34X10D	30	CROSSHEAD W/DT SMOOTH
CCA34X10K	30	CROSSHEAD W/KEY SMOOTH
CCA34X10T	30	CROSSHEAD W/TS SMOOTH
CCA34X11BT	30	CROSSHEAD W/BT SMOOTH
CCA36X10	30	CROSSHEAD SMOOTH
CCA36X10D	30	CROSSHEAD W/DT SMOOTH
CCA36X10K	30	CROSSHEAD SMOOTH
CCA36X10T	30	CROSSHEAD W/TS SMOOTH
CCA36X11BT	30	CROSSHEAD W/BT SMOOTH
CCA40X10	30	CROSSHEAD SMOOTH
CCA40X10D	30	CROSSHEAD W/DT SMOOTH
CCA40X10K	30	CROSSHEAD W/KEY SMOOTH
CCA40X10T	30	CROSSHEAD W/TS SMOOTH
CCA40X11BT	30	CROSSHEAD W/BT SMOOTH
CCA47X10	30	CROSSHEAD SMOOTH

PART NUMBER	PAGE	DESCRIPTION
CCA47X10D	30	CROSSHEAD W/DT SMOOTH
CCA47X10K	30	CROSSHEAD W/KEY SMOOTH
CCA47X10T	30	CROSSHEAD W/TS SMOOTH
CCA47X11BT	30	CROSSHEAD W/BT SMOOTH
CCA52X10	30	CROSSHEAD SMOOTH
CCA52X10D	30	CROSSHEAD W/DT SMOOTH
CCA52X10K	30	CROSSHEAD W/KEY SMOOTH
CCA52X10T	30	CROSSHEAD W/TS SMOOTH
CCA52X11BT	30	CROSSHEAD W/BT SMOOTH
CCA64X10	30	CROSSHEAD SMOOTH
CCA64X10D	30	CROSSHEAD W/DT SMOOTH
CCA64X10K	30	CROSSHEAD W/KEY SMOOTH
CCA64X10T	30	CROSSHEAD W/TS SMOOTH
CCA64X11BT	30	CROSSHEAD W/BT SMOOTH
CCA72X10	30	CROSSHEAD SMOOTH
CCA72X10D	30	CROSSHEAD W/DT SMOOTH
CCA72X10K	30	CROSSHEAD SMOOTH
CCA72X10T	30	CROSSHEAD W/TS SMOOTH
CCA72X11BT	30	CROSSHEAD W/BT SMOOTH
CCA100X10	30	CROSSHEAD SMOOTH
CCA100X10D	30	CROSSHEAD W/DT SMOOTH
CCA100X10K	30	CROSSHEAD W/KEY SMOOTH
CCA100X10T	30	CROSSHEAD W/TS SMOOTH
CCA100X11BT	30	CROSSHEAD W/BT SMOOTH
CCA106X10	30	CROSSHEAD SMOOTH
CCA106X10D	30	CROSSHEAD W/DT SMOOTH
CCA106X10K	30	CROSSHEAD W/KEY SMOOTH
CCA106X10T	30	CROSSHEAD W/TS SMOOTH
CCA106X11BT	30	CROSSHEAD W/BT SMOOTH
CCA199X10	30	CROSSHEAD SMOOTH
CCA199X10D	30	CROSSHEAD W/DT SMOOTH
CCA199X10K	30	CROSSHEAD W/KEY SMOOTH
CCA199X10T	30	CROSSHEAD W/TS SMOOTH
CCA199X11BT	30	CROSSHEAD W/BT SMOOTH
CCA200X10	30	CROSSHEAD SMOOTH
CCA200X10D	30	CROSSHEAD W/DT SMOOTH
CCA200X10K	30	CROSSHEAD W/KEY SMOOTH
CCA200X10T	30	CROSSHEAD W/TS SMOOTH
CCA200X11BT	30	CROSSHEAD W/BT SMOOTH
CCP37	39	PEDIMENT COMBO PEAKED CAP SMOOTH
CCP37BT	39	PEDIMENT COMBO PEAKED W/BT SMOOTH
<b>DISTINCTION 6" READY-TO-INSTALL</b>		
CH2_X6EC	17	DISTINCTION 6" READY-TO-INSTALL WITH END CAPS
<b>DISTINCTION 6" READY-TO-INSTALL BOTTOM TRIM</b>		
CH_X7ECBT	18	DISTINCTION 6" READY-TO-INSTALL WITH END CAPS & BOTTOM TRIM
<b>DISTINCTION 6" READY-TO-INSTALL DENTIL TRIM</b>		
CH_X6ECD	18	DISTINCTION 6" READY-TO-INSTALL WITH END CAPS & DENTIL TRIM
<b>DISTINCTION 6" READY-TO-INSTALL WITH KEystone</b>		
CH_X6ECK	17	DISTINCTION 6" READY-TO-INSTALL WITH END CAPS & KEystone
<b>DISTINCTION 9" READY-TO-INSTALL</b>		
CH_X9EC	17	DISTINCTION 9" READY-TO-INSTALL WITH END CAPS
<b>DISTINCTION 9" READY-TO-INSTALL WITH DENTIL TRIM</b>		
CH_X9ECD	17	DISTINCTION 9" READY-TO-INSTALL WITH END CAPS & BOTTOM TRIM
<b>DISTINCTION 9" READY-TO-INSTALL BOTTOM TRIM</b>		
CH_X10ECBT	17	DISTINCTION 9" READY-TO-INSTALL WITH END CAPS & DENTIL TRIM

PART NUMBER	PAGE	DESCRIPTION
<b>DISTINCTION 9" READY-TO-INSTALL WITH KEystone</b>		
CH_X9ECK	17	DISTINCTION 9" READY-TO-INSTALL WITH END CAPS & KEystone
<b>DISTINCTION 6" READY-TO-INSTALL CROSSHEAD FOR 5" PILASTER</b>		
CH_X6EC5	17	DISTINCTION 6" READY-TO-INSTALL WITH END CAPS 5" PILASTER
<b>DISTINCTION 9" READY-TO-INSTALL CROSSHEAD FOR 5" PILASTER</b>		
CH_X9EC5	17	DISTINCTION 9" READY-TO-INSTALL WITH END CAPS 5" PILASTER
<b>DISTINCTION 6" READY-TO-INSTALL CROSSHEAD FOR 7" PILASTER</b>		
CH_X6EC7	17	DISTINCTION 6" READY-TO-INSTALL WITH END CAPS 7" PILASTER
<b>DISTINCTION 9" READY-TO-INSTALL CROSSHEAD FOR 7" PILASTER</b>		
CH_X9EC7	17	DISTINCTION 9" READY-TO-INSTALL WITH END CAPS 7" PILASTER
<b>DISTINCTION 6" READY-TO-INSTALL CROSSHEAD FOR 9" PILASTER</b>		
CH51X6EC9	17	DISTINCTION 6" READY-TO-INSTALL WITH END CAPS 9" PILASTER
<b>DISTINCTION 9" READY-TO-INSTALL CROSSHEAD FOR 9" PILASTER</b>		
CH51X9EC9	17	DISTINCTION 9" READY-TO-INSTALL WITH END CAPS 9" PILASTER
<b>DISTINCTION END CAPS</b>		
CHC2X6	19	DISTINCTION CROSSHEAD END CAP
CHC2X6-5	19	DISTINCTION CROSSHEAD END CAP
CHC4X6	19	DISTINCTION CROSSHEAD END CAP
CHC4X6-5	19	DISTINCTION CROSSHEAD END CAP
CHC7X6	19	DISTINCTION CROSSHEAD END CAP
CHC7X6-5	19	DISTINCTION CROSSHEAD END CAP
CHC11X6	19	DISTINCTION CROSSHEAD END CAP
CHC11X6-5	19	DISTINCTION CROSSHEAD END CAP
CHC2X9	19	DISTINCTION CROSSHEAD END CAP
CHC2X9-5	19	DISTINCTION CROSSHEAD END CAP
CHC4X9	19	DISTINCTION CROSSHEAD END CAP
CHC4X9-5	19	DISTINCTION CROSSHEAD END CAP
CHC7X9	19	DISTINCTION CROSSHEAD END CAP
CHC7X9-5	19	DISTINCTION CROSSHEAD END CAP
CHC11X9	19	DISTINCTION CROSSHEAD END CAP
CHC11X9-5	19	DISTINCTION CROSSHEAD END CAP
<b>CRAFTSMAN COVE READY-TO-INSTALL</b>		
CHCC_X9BTEC	21	CRAFTSMAN COVE CROSSHEAD READY-TO-INSTALL
<b>CRAFTSMAN COVE END CAPS</b>		
CHCC4X9BT	23	CRAFTSMAN COVE CROSSHEAD END CAPS
CHCC4X9BT-5	23	CRAFTSMAN COVE CROSSHEAD END CAPS
CHCC6X9BT	23	CRAFTSMAN COVE CROSSHEAD END CAPS
CHCC6X9BT-5	23	CRAFTSMAN COVE CROSSHEAD END CAPS
<b>CRAFTSMAN COVE TRIMMABLE</b>		
CHCCT36X9BT	23	TRIMMABLE CRAFTSMAN COVE CROSSHEAD
CHCCT48X9BT	23	TRIMMABLE CRAFTSMAN COVE CROSSHEAD
CHCCT144X9BT	23	TRIMMABLE CRAFTSMAN COVE CROSSHEAD
CHCCT216X9BT	23	TRIMMABLE CRAFTSMAN COVE CROSSHEAD
<b>CRAFTSMAN STEP 6" TRIMMABLE</b>		
CHCST36X6	25	CRAFTSMAN STEP CROSSHEAD
CHCST48X6	25	CRAFTSMAN STEP CROSSHEAD
CHCST144X6	25	CRAFTSMAN STEP CROSSHEAD
CHCST216X6	25	CRAFTSMAN STEP CROSSHEAD
<b>CRAFTSMAN STEP 8" TRIMMABLE</b>		
CHCST36X8	25	CRAFTSMAN STEP CROSSHEAD
CHCST48X8	25	CRAFTSMAN STEP CROSSHEAD
CHCST144X8	25	CRAFTSMAN STEP CROSSHEAD
CHCST216X8	25	CRAFTSMAN STEP CROSSHEAD
<b>DISTINCTION 6" TRIMMABLE</b>		
CHT36X6	19	TRIMMABLE CROSSHEAD 36X6
CHT48X6	19	TRIMMABLE CROSSHEAD 48X9

PART NUMBER	PAGE	DESCRIPTION
CHT144X6	19	TRIMMABLE CROSSHEAD 144X6
CHT216X6	19	TRIMMABLE CROSSHEAD 216X6
<b>DISTINCTION 9" TRIMMABLE</b>		
CHT36X9	19	TRIMMABLE CROSSHEAD 36X9
CHT48X9	19	TRIMMABLE CROSSHEAD 48X9
CHT144X9	19	TRIMMABLE CROSSHEAD 144X9
CHT216X9	19	TRIMMABLE CROSSHEAD 216X9
CIR24X4F	51	TRIM CIRCLE SMOOTH
CIR36X4F	51	TRIM CIRCLE SMOOTH
CLV12X24	184	CATHEDRAL LOUVER DECO SMOOTH
CLV14X22	184	CATHEDRAL LOUVER DECO SMOOTH
CLV16X36	184	CATHEDRAL LOUVER DECO SMOOTH
CLV18X24	184	CATHEDRAL LOUVER DECO SMOOTH
CLV18X30	184	CATHEDRAL LOUVER DECO SMOOTH
CLV18X30X4F	184	TRIM CATHEDRAL LOUVER SMOOTH
CLV18X54	184	CATHEDRAL LOUVER DECO SMOOTH
CLV22X31	184	CATHEDRAL LOUVER DECO SMOOTH
CLV22X31X4F	184	TRIM CATHEDRAL LOUVER SMOOTH
CLV24X48	184	CATHEDRAL LOUVER DECO SMOOTH
CLV28X43	184	CATHEDRAL LOUVER DECO SMOOTH
CLV36X48	184	CATHEDRAL LOUVER DECO SMOOTH
CM15BM	168	CEILING MEDALLION 1PC BEAUMONT SMOOTH
CM16FL	166	CEILING MEDALLION 1PC FLORENTINE SMOOTH
CM16FL2	166	CEILING MEDALLION 2PC FLOR SMOOTH
CM16JE2	166	CEILING MEDALLION 2PC JEFFERSON SMOOTH
CM24RN	166	CEILING MEDALLION 1PC RANDOLPH SMOOTH
CM36NI	166	CEILING MEDALLION 1PC NICHOLAS SMOOTH
CM67WT	166	CEILING MEDALLION 1PC WHITNEY SMOOTH
CN6X6	163	COVER VENT
COL11X108PSQ	218	COLUMN SQUARE PLAIN SMOOTH
COL11X96PSQ	218	COLUMN SQUARE PLAIN SMOOTH
COL8X96PSQ	218	COLUMN SQUARE PLAIN SMOOTH
COR11X11X5S	152	CORBEL, TIMBER TEXTURE
COR11X13X6S	155	CORBEL, TIMBER TEXTURE
COR12X18X6S	156	CORBEL, TIMBER TEXTURE
COR14X12X6S	155	CORBEL, TIMBER TEXTURE
COR16X10X8S	155	CORBEL, TIMBER TEXTURE
COR16X7X3S	156	CORBEL, TIMBER TEXTURE
COR16X8S	156	CORBEL, TIMBER TEXTURE
COR18X8X6S	152	CORBEL, TIMBER TEXTURE
COR18X9X3S	156	CORBEL, TIMBER TEXTURE
COR24X5X5S	156	CORBEL, TIMBER TEXTURE
COR24X8X4S	156	CORBEL, TIMBER TEXTURE
COR24X8X6S	152	CORBEL, TIMBER TEXTURE
COR39X10X5.5S	155	CORBEL, TIMBER TEXTURE
COR5X5S	152	CORBEL, TIMBER TEXTURE
COR5X5X3S	152	CORBEL, TIMBER TEXTURE
COR7X11S	154	CORBEL, TIMBER TEXTURE
COR7X13X7S	152	CORBEL, TIMBER TEXTURE
COR7X15X4S	156	CORBEL, TIMBER TEXTURE
COR8X8X6S	152	CORBEL, TIMBER TEXTURE
CORCV18X12X6S	152	CORBEL, TIMBER TEXTURE, COVE
CORCV18X6X6S	152	CORBEL, TIMBER TEXTURE, COVE
CORCV18X8X4S	152	CORBEL, TIMBER TEXTURE, COVE
CORCV18X8X6S	152	CORBEL, TIMBER TEXTURE, COVE
COROG15X7S	154	CORBEL, TIMBER TEXTURE

PART NUMBER	PAGE	DESCRIPTION
COROG20X7S	154	CORBEL, TIMBER TEXTURE, OGEE
COROG24X6S	154	CORBEL, TIMBER TEXTURE, OGEE
COROG8X12S	154	CORBEL, TIMBER TEXTURE, OGEE
COROGA15X7S	154	CORBEL, TIMBER TEXTURE
COROGD15X7S	154	CORBEL, TIMBER TEXTURE
CPCP48	38	PEDIMENT COMBO PEAKED CAP SMOOTH
CPCP48BT	38	PEDIMENT COMBO PEAKED W/BT SMOOTH
CPCP50	38	PEDIMENT COMBO PEAKED CAP SMOOTH
CPCP50BT	38	PEDIMENT COMBO PEAKED CAP W/BT SMOOTH
CPCP54	38	PEDIMENT COMBO PEAKED CAP SMOOTH
CPCP54BT	38	PEDIMENT COMBO PEAKED W/BT SMOOTH
CPCP58	38	PEDIMENT COMBO PEAKED CAP SMOOTH
CPCP58BT	38	PEDIMENT COMBO PEAKED CAP W/BT SMOOTH
CPCP67	38	PEDIMENT COMBO PEAKED CAP SMOOTH
CPCP67BT	38	PEDIMENT COMBO PEAKED CAP W/BT SMOOTH
CPCP75	38	PEDIMENT COMBO PEAKED CAP SMOOTH
CPCP75BT	38	PEDIMENT COMBO PEAKED CAP W/BT SMOOTH
CPCP80	38	PEDIMENT COMBO PEAKED CAP SMOOTH
CPCP80BT	38	PEDIMENT COMBO PEAKED W/BT SMOOTH
CPCP85	38	PEDIMENT COMBO PEAKED CAP SMOOTH
CPCP85BT	38	PEDIMENT COMBO PEAKED CAP W/BT SMOOTH
CRHP54	41	PEDIMENT COMBO RAMS HEAD SMOOTH
CRHP54BT	41	PEDIMENT COMBO RAMS HEAD W/BT SMOOTH
CRHP67	41	PEDIMENT COMBO RAMS HEAD SMOOTH
CRHP67BT	41	PEDIMENT COMBO RAMS HEAD W/BT SMOOTH
CRHP75	41	PEDIMENT COMBO RAMS HEAD SMOOTH
CRHP75BT	41	PEDIMENT COMBO RAMS HEAD W/BT SMOOTH
CRHP80	41	PEDIMENT COMBO RAMS HEAD SMOOTH
CRHP80BT	41	PEDIMENT COMBO RAMS HEAD W/BT SMOOTH
CRHP85	41	PEDIMENT COMBO RAMS HEAD SMOOTH
CRHP85BT	41	PEDIMENT COMBO RAMS HEAD W/BT SMOOTH
CSAP36	37	PEDIMENT COMBO SGMT ARCH SMOOTH
CSAP36BT	37	PEDIMENT COMBO SGMT ARCH W/BT SMOOTH
CSAP48	37	PEDIMENT COMBO SGMT ARCH SMOOTH
CSAP48BT	37	PEDIMENT COMBO SGMT ARCH W/BT SMOOTH
CSAP65	37	PEDIMENT COMBO SGMT ARCH SMOOTH
CSAP65BT	37	PEDIMENT COMBO SGMT ARCH W/BT SMOOTH
CSAP84	37	PEDIMENT COMBO SGMT ARCH SMOOTH
CSAP84BT	37	PEDIMENT COMBO SGMT ARCH W/BT SMOOTH
CSP54	37	PEDIMENT COMBO SUNBURST SMOOTH
CSP54BT	37	PEDIMENT COMBO SUNBURST W/BT SMOOTH
CSP75	37	PEDIMENT COMBO SUNBURST SMOOTH
CSP75BT	37	PEDIMENT COMBO SUNBURST W/BT SMOOTH
CSP80	37	PEDIMENT COMBO SUNBURST SMOOTH
CSP80BT	37	PEDIMENT COMBO SUNBURST W/BT SMOOTH
CSP85	37	PEDIMENT COMBO SUNBURST SMOOTH
CSP85BT	37	PEDIMENT COMBO SUNBURST W/BT SMOOTH
<b>COLUMN WRAP ACCESSORIES</b>		
CW6NM	232	COLUMN WRAP CAP BASE 6X6 NECK MOULD
CW8NM	232	COLUMN WRAP CAP BASE 8X8 NECK MOULD
CW10NM	232	COLUMN WRAP CAP BASE 10X10 NECK MOULD
CW12NM	232	COLUMN WRAP CAP BASE 12X12 NECK MOULD
CW17NM	237	COLUMN WRAP CAP BASE 17X17 NECK MOULD
CWCB6CF	232	COLUMN WRAP CAP BASE 6X6 CRAFTSMAN
CWCB8CF	232	COLUMN WRAP CAP BASE 8X8 CRAFTSMAN
CWCB10CF	232	COLUMN WRAP CAP BASE 10X10 CRAFTSMAN
CWCB12CF	232	COLUMN WRAP CAP BASE 12X12 CRAFTSMAN

PART NUMBER	PAGE	DESCRIPTION
CWCB8X12CF	237	COLUMN WRAP CAP BASE 8X12 CRAFTSMAN
CWCB11X16CF	237	COLUMN WRAP CAP BASE 11X16 CRAFTSMAN
CWCB13X20CF	237	COLUMN WRAP CAP BASE 13X20 CRAFTSMAN
CWCB16X24CF	237	COLUMN WRAP CAP BASE 16X24 CRAFTSMAN
CWCB6GK	232	COLUMN WRAP CAP BASE 6X6 GREEK
CWCB8GK	232	COLUMN WRAP CAP BASE 8X8 GREEK
CWCB10GK	232	COLUMN WRAP CAP BASE 10X10 GREEK
CWCB12GK	232	COLUMN WRAP CAP BASE 12X12 GREEK
CWCB8X12GK	237	COLUMN WRAP CAP BASE 8X12 GREEK
CWCB11X16GK	237	COLUMN WRAP CAP BASE 11X16 GREEK
CWCB13X20GK	237	COLUMN WRAP CAP BASE 13X20 GREEK
CWCB16X24GK	237	COLUMN WRAP CAP BASE 16X24 GREEK
CWCB6PL	232	COLUMN WRAP CAP BASE 6X6 PLAIN
CWCB8PL	232	COLUMN WRAP CAP BASE 8X8 PLAIN
CWCB10PL	232	COLUMN WRAP CAP BASE 10X10 PLAIN
CWCB12PL	232	COLUMN WRAP CAP BASE 12X12 PLAIN
CWCB6RO	232	COLUMN WRAP CAP BASE 6X6 ROMAN
CWCB8RO	232	COLUMN WRAP CAP BASE 8X8 ROMAN
CWCB10RO	232	COLUMN WRAP CAP BASE 10X10 ROMAN
CWCB12RO	232	COLUMN WRAP CAP BASE 12X12 ROMAN
CWCB8X12RO	237	COLUMN WRAP CAP BASE 8X12 ROMAN
CWCB11X16RO	237	COLUMN WRAP CAP BASE 11X16 ROMAN
CWCB13X20RO	237	COLUMN WRAP CAP BASE 13X20 ROMAN
CWCB16X24RO	237	COLUMN WRAP CAP BASE 16X24 ROMAN
CWCB6TR	232	COLUMN WRAP CAP BASE 6X6 TRADITIONAL
CWCB8TR	232	COLUMN WRAP CAP BASE 8X8 TRADITIONAL
CWCB10TR	232	COLUMN WRAP CAP BASE 10X10 TRADITIONAL
CWCB12TR	232	COLUMN WRAP CAP BASE 12X12 TRADITIONAL
CWCB6TS	232	COLUMN WRAP CAP BASE 6X6 TUSCAN
CWCB8TS	232	COLUMN WRAP CAP BASE 8X8 TUSCAN
CWCB10TS	232	COLUMN WRAP CAP BASE 10X10 TUSCAN
CWCB12TS	232	COLUMN WRAP CAP BASE 12X12 TUSCAN
CWCB8X12TS	237	COLUMN WRAP CAP BASE 8X12 TUSCAN
CWCB11X16TS	237	COLUMN WRAP CAP BASE 11X16 TUSCAN
CWCB13X20TS	237	COLUMN WRAP CAP BASE 13X20 TUSCAN
CWCB16X24TS	237	COLUMN WRAP CAP BASE 16X24 TUSCAN
CWINSTALLKIT	228	INSTALLATION KIT
<b>COLUMN WRAP PREMIUM SELECT</b>		
CWPM6X72SFT	231	PREMIUMSELECT SQUARE FLAT 6X6X72
CWPM6X96SFT	231	PREMIUMSELECT SQUARE FLAT 6X6X96
CWPM6X108SFT	231	PREMIUMSELECT SQUARE FLAT 6X6X108
CWPM6X120SFT	231	PREMIUMSELECT SQUARE FLAT 6X6X120
CWPM6X144SFT	231	PREMIUMSELECT SQUARE FLAT 6X6X144
CWPM8X72SFT	231	PREMIUMSELECT SQUARE FLAT 8X8X72
CWPM8X96SFT	231	PREMIUMSELECT SQUARE FLAT 8X8X96
CWPM8X108SFT	231	PREMIUMSELECT SQUARE FLAT 8X8X108
CWPM8X120SFT	231	PREMIUMSELECT SQUARE FLAT 8X8X120
CWPM8X144SFT	231	PREMIUMSELECT SQUARE FLAT 8X8X144
CWPM10X72SFT	231	PREMIUMSELECT SQUARE FLAT 10X10X72
CWPM10X96SFT	231	PREMIUMSELECT SQUARE FLAT 10X10X96
CWPM10X108SFT	231	PREMIUMSELECT SQUARE FLAT 10X10X108
CWPM10X120SFT	231	PREMIUMSELECT SQUARE FLAT 10X10X120
CWPM10X144SFT	231	PREMIUMSELECT SQUARE FLAT 10X10X144
CWPM12X72SFT	231	PREMIUMSELECT SQUARE FLAT 12X12X72
CWPM12X96SFT	231	PREMIUMSELECT SQUARE FLAT 12X12X96
CWPM12X108SFT	231	PREMIUMSELECT SQUARE FLAT 12X12X108
CWPM12X120SFT	231	PREMIUMSELECT SQUARE FLAT 12X12X120
CWPM12X144SFT	231	PREMIUMSELECT SQUARE FLAT 12X12X144
CWPM12X120SFT	231	PREMIUMSELECT SQUARE FLAT 12X12X120

PART NUMBER	PAGE	DESCRIPTION
CWPM12X144SFT	231	PREMIUMSELECT SQUARE FLAT 12X12X144
CWPM8X72SFL	231	PREMIUMSELECT SQUARE FLUTED 8X8X72
CWPM8X96SFL	231	PREMIUMSELECT SQUARE FLUTED 8X8X96
CWPM8X108SFL	231	PREMIUMSELECT SQUARE FLUTED 8X8X108
CWPM8X120SFL	231	PREMIUMSELECT SQUARE FLUTED 8X8X120
CWPM8X144SFL	231	PREMIUMSELECT SQUARE FLUTED 8X8X144
CWPM10X72SFL	231	PREMIUMSELECT SQUARE FLUTED 10X10X72
CWPM10X96SFL	231	PREMIUMSELECT SQUARE FLUTED 10X10X96
CWPM10X108SFL	231	PREMIUMSELECT SQUARE FLUTED 10X10X108
CWPM10X120SFL	231	PREMIUMSELECT SQUARE FLUTED 10X10X120
CWPM10X144SFL	231	PREMIUMSELECT SQUARE FLUTED 10X10X144
CWPM12X72SFL	231	PREMIUMSELECT SQUARE FLUTED 12X12X72
CWPM12X96SFL	231	PREMIUMSELECT SQUARE FLUTED 12X12X96
CWPM12X108SFL	231	PREMIUMSELECT SQUARE FLUTED 12X12X108
CWPM12X120SFL	231	PREMIUMSELECT SQUARE FLUTED 12X12X120
CWPM12X144SFL	231	PREMIUMSELECT SQUARE FLUTED 12X12X144
CWPM8X72SRS	231	PREMIUMSELECT SQUARE RAISED 8X8X72
CWPM8X96SRS	231	PREMIUMSELECT SQUARE RAISED 8X8X96
CWPM8X108SRS	231	PREMIUMSELECT SQUARE RAISED 8X8X108
CWPM8X120SRS	231	PREMIUMSELECT SQUARE RAISED 8X8X120
CWPM8X144SRS	231	PREMIUMSELECT SQUARE RAISED 8X8X144
CWPM10X72SRS	231	PREMIUMSELECT SQUARE RAISED 10X10X72
CWPM10X96SRS	231	PREMIUMSELECT SQUARE RAISED 10X10X96
CWPM10X108SRS	231	PREMIUMSELECT SQUARE RAISED 10X10X108
CWPM10X120SRS	231	PREMIUMSELECT SQUARE RAISED 10X10X120
CWPM10X144SRS	231	PREMIUMSELECT SQUARE RAISED 10X10X144
CWPM12X72SRS	231	PREMIUMSELECT SQUARE RAISED 12X12X72
CWPM12X96SRS	231	PREMIUMSELECT SQUARE RAISED 12X12X96
CWPM12X108SRS	231	PREMIUMSELECT SQUARE RAISED 12X12X108
CWPM12X120SRS	231	PREMIUMSELECT SQUARE RAISED 12X12X120
CWPM12X144SRS	231	PREMIUMSELECT SQUARE RAISED 12X12X144
CWPM8X72SRC	231	PREMIUMSELECT SQUARE RECESSED 8X8X72
CWPM8X96SRC	231	PREMIUMSELECT SQUARE RECESSED 8X8X96
CWPM8X108SRC	231	PREMIUMSELECT SQUARE RECESSED 8X8X108
CWPM8X120SRC	231	PREMIUMSELECT SQUARE RECESSED 8X8X120
CWPM8X144SRC	231	PREMIUMSELECT SQUARE RECESSED 8X8X144
CWPM10X72SRC	231	PREMIUMSELECT SQUARE RECESSED 10X10X72
CWPM10X96SRC	231	PREMIUMSELECT SQUARE RECESSED 10X10X96
CWPM10X108SRC	231	PREMIUMSELECT SQUARE RECESSED 10X10X108
CWPM10X120SRC	231	PREMIUMSELECT SQUARE RECESSED 10X10X120
CWPM10X144SRC	231	PREMIUMSELECT SQUARE RECESSED 10X10X144
CWPM12X72SRC	231	PREMIUMSELECT SQUARE RECESSED 12X12X72
CWPM12X96SRC	231	PREMIUMSELECT SQUARE RECESSED 12X12X96
CWPM12X108SRC	231	PREMIUMSELECT SQUARE RECESSED 12X12X108
CWPM12X120SRC	231	PREMIUMSELECT SQUARE RECESSED 12X12X120
CWPM12X144SRC	231	PREMIUMSELECT SQUARE RECESSED 12X12X144
CWPM8X12X48TFT	234	PREMIUMSELECT TAPERED FLAT 8X12X48
CWPM8X12X54TFT	234	PREMIUMSELECT TAPERED FLAT 8X12X54
CWPM8X12X60TFT	234	PREMIUMSELECT TAPERED FLAT 8X12X60
CWPM8X12X66TFT	234	PREMIUMSELECT TAPERED FLAT 8X12X66
CWPM8X12X72TFT	234	PREMIUMSELECT TAPERED FLAT 8X12X72
CWPM8X12X96TFT	234	PREMIUMSELECT TAPERED FLAT 8X12X96
CWPM11X16X48TFT	234	PREMIUMSELECT TAPERED FLAT 11X16X48
CWPM11X16X54TFT	234	PREMIUMSELECT TAPERED FLAT 11X16X54
CWPM11X16X60TFT	234	PREMIUMSELECT TAPERED FLAT 11X16X60
CWPM11X16X66TFT	234	PREMIUMSELECT TAPERED FLAT 11X16X66
CWPM11X16X72TFT	234	PREMIUMSELECT TAPERED FLAT 11X16X72

PART NUMBER	PAGE	DESCRIPTION
CWPM11X16X96TFT	234	PREMIUMSELECT TAPERED FLAT 11X16X96
CWPM13X20X48TFT	234	PREMIUMSELECT TAPERED FLAT 13X20X48
CWPM13X20X54TFT	234	PREMIUMSELECT TAPERED FLAT 13X20X54
CWPM13X20X60TFT	234	PREMIUMSELECT TAPERED FLAT 13X20X60
CWPM13X20X66TFT	234	PREMIUMSELECT TAPERED FLAT 13X20X66
CWPM13X20X72TFT	234	PREMIUMSELECT TAPERED FLAT 13X20X72
CWPM13X20X96TFT	234	PREMIUMSELECT TAPERED FLAT 13X20X96
CWPM16X24X48TFT	234	PREMIUMSELECT TAPERED FLAT 16X24X48
CWPM16X24X54TFT	234	PREMIUMSELECT TAPERED FLAT 16X24X54
CWPM16X24X60TFT	234	PREMIUMSELECT TAPERED FLAT 16X24X60
CWPM16X24X66TFT	234	PREMIUMSELECT TAPERED FLAT 16X24X66
CWPM16X24X72TFT	234	PREMIUMSELECT TAPERED FLAT 16X24X72
CWPM16X24X96TFT	234	PREMIUMSELECT TAPERED FLAT 16X24X96
CWPM8X12X48TRS	234	PREMIUMSELECT TAPERED RAISED 8X12X48
CWPM8X12X54TRS	234	PREMIUMSELECT TAPERED RAISED 8X12X54
CWPM8X12X60TRS	234	PREMIUMSELECT TAPERED RAISED 8X12X60
CWPM8X12X66TRS	234	PREMIUMSELECT TAPERED RAISED 8X12X66
CWPM8X12X72TRS	234	PREMIUMSELECT TAPERED RAISED 8X12X72
CWPM8X12X96TRS	234	PREMIUMSELECT TAPERED RAISED 8X12X96
CWPM11X16X48TRS	234	PREMIUMSELECT TAPERED RAISED 11X16X48
CWPM11X16X54TRS	234	PREMIUMSELECT TAPERED RAISED 11X16X54
CWPM11X16X60TRS	234	PREMIUMSELECT TAPERED RAISED 11X16X60
CWPM11X16X66TRS	234	PREMIUMSELECT TAPERED RAISED 11X16X66
CWPM11X16X72TRS	234	PREMIUMSELECT TAPERED RAISED 11X16X72
CWPM11X16X96TRS	234	PREMIUMSELECT TAPERED RAISED 11X16X96
CWPM13X20X48TRS	234	PREMIUMSELECT TAPERED RAISED 13X20X48
CWPM13X20X54TRS	234	PREMIUMSELECT TAPERED RAISED 13X20X54
CWPM13X20X60TRS	234	PREMIUMSELECT TAPERED RAISED 13X20X60
CWPM13X20X66TRS	234	PREMIUMSELECT TAPERED RAISED 13X20X66
CWPM13X20X72TRS	234	PREMIUMSELECT TAPERED RAISED 13X20X72
CWPM13X20X96TRS	234	PREMIUMSELECT TAPERED RAISED 13X20X96
CWPM16X24X48TRS	234	PREMIUMSELECT TAPERED RAISED 16X24X48
CWPM16X24X54TRS	234	PREMIUMSELECT TAPERED RAISED 16X24X54
CWPM16X24X60TRS	234	PREMIUMSELECT TAPERED RAISED 16X24X60
CWPM16X24X66TRS	234	PREMIUMSELECT TAPERED RAISED 16X24X66
CWPM16X24X72TRS	234	PREMIUMSELECT TAPERED RAISED 16X24X72
CWPM16X24X96TRS	234	PREMIUMSELECT TAPERED RAISED 16X24X96
CWPM8X12X48TRC	234	PREMIUMSELECT TAPERED RECESSED 8X12X48
CWPM8X12X54TRC	234	PREMIUMSELECT TAPERED RECESSED 8X12X54
CWPM8X12X60TRC	234	PREMIUMSELECT TAPERED RECESSED 8X12X60
CWPM8X12X66TRC	234	PREMIUMSELECT TAPERED RECESSED 8X12X66
CWPM8X12X72TRC	234	PREMIUMSELECT TAPERED RECESSED 8X12X72
CWPM8X12X96TRC	234	PREMIUMSELECT TAPERED RECESSED 8X12X96
CWPM11X16X48TRC	234	PREMIUMSELECT TAPERED RECESSED 11X16X48
CWPM11X16X54TRC	234	PREMIUMSELECT TAPERED RECESSED 11X16X54
CWPM11X16X60TRC	234	PREMIUMSELECT TAPERED RECESSED 11X16X60
CWPM11X16X66TRC	234	PREMIUMSELECT TAPERED RECESSED 11X16X66
CWPM11X16X72TRC	234	PREMIUMSELECT TAPERED RECESSED 11X16X72
CWPM11X16X96TRC	234	PREMIUMSELECT TAPERED RECESSED 11X16X96
CWPM13X20X48TRC	234	PREMIUMSELECT TAPERED RECESSED 13X20X48
CWPM13X20X54TRC	234	PREMIUMSELECT TAPERED RECESSED 13X20X54
CWPM13X20X60TRC	234	PREMIUMSELECT TAPERED RECESSED 13X20X60
CWPM13X20X66TRC	234	PREMIUMSELECT TAPERED RECESSED 13X20X66
CWPM13X20X72TRC	234	PREMIUMSELECT TAPERED RECESSED 13X20X72
CWPM13X20X96TRC	234	PREMIUMSELECT TAPERED RECESSED 13X20X96
CWPM16X24X48TRC	234	PREMIUMSELECT TAPERED RECESSED 16X24X48
CWPM16X24X54TRC	234	PREMIUMSELECT TAPERED RECESSED 16X24X54



PART NUMBER	PAGE	DESCRIPTION
CWPM16X24X60TRC	234	PREMIUMSELECT TAPERED RECESSED 16X24X60
CWPM16X24X66TRC	234	PREMIUMSELECT TAPERED RECESSED 16X24X66
CWPM16X24X72TRC	234	PREMIUMSELECT TAPERED RECESSED 16X24X72
CWPM16X24X96TRC	234	PREMIUMSELECT TAPERED RECESSED 16X24X96
COLUMN WRAP PROSELECT		
CWPR6X72SFT	228	PROSELECT SQUARE FLAT 6X6X72
CWPR6X96SFT	228	PROSELECT SQUARE FLAT 6X6X96
CWPR6X108SFT	228	PROSELECT SQUARE FLAT 6X6X108
CWPR6X120SFT	228	PROSELECT SQUARE FLAT 6X6X120
CWPR6X144SFT	228	PROSELECT SQUARE FLAT 6X6X144
CWPR8X72SFT	228	PROSELECT SQUARE FLAT 8X8X72
CWPR8X96SFT	228	PROSELECT SQUARE FLAT 8X8X96
CWPR8X108SFT	228	PROSELECT SQUARE FLAT 8X8X108
CWPR8X120SFT	228	PROSELECT SQUARE FLAT 8X8X120
CWPR8X144SFT	228	PROSELECT SQUARE FLAT 8X8X144
CWPR10X72SFT	228	PROSELECT SQUARE FLAT 10X10X72
CWPR10X96SFT	228	PROSELECT SQUARE FLAT 10X10X96
CWPR10X108SFT	228	PROSELECT SQUARE FLAT 10X10X108
CWPR10X120SFT	228	PROSELECT SQUARE FLAT 10X10X120
CWPR10X144SFT	228	PROSELECT SQUARE FLAT 10X10X144
CWPR12X72SFT	228	PROSELECT SQUARE FLAT 12X12X72
CWPR12X96SFT	228	PROSELECT SQUARE FLAT 12X12X96
CWPR12X108SFT	228	PROSELECT SQUARE FLAT 12X12X108
CWPR12X120SFT	228	PROSELECT SQUARE FLAT 12X12X120
CWPR12X144SFT	228	PROSELECT SQUARE FLAT 12X12X144
D		
DLV24X24	197	DIAMOND LOUVER DECO SMOOTH
DMP44	52	DORMER TRIM SYSTEM PEDIMENT SMOOTH
DMR457-10	52	DORMER TRIM SYSTEM RETURN SMOOTH
DMST7X69	52	DORMER TRIM SYSTEM SIDE TRIM SMOOTH
DP28X28SQX	162	DECORATIVE PANEL SQUARE SMOOTH
DSKCOL3068	56	DOOR TRIM KIT SMOOTH
DSKCR3068	54	DOOR TRIM KIT SMOOTH
DSKEMP3068	56	DOOR TRIM KIT SMOOTH
DSKD05F966	57	DOOR TRIM KIT SMOOTH
DSKD05F966K	57	DOOR TRIM KIT SMOOTH
DSKD05P966	55	DOOR TRIM KIT SMOOTH
DSKD05P966K	55	DOOR TRIM KIT SMOOTH
DSKD07F939	57	DOOR TRIM KIT SMOOTH
DSKD07F939K	57	DOOR TRIM KIT SMOOTH
DSKD07F9612	57	DOOR TRIM KIT SMOOTH
DSKD07F9612K	57	DOOR TRIM KIT SMOOTH
DSKD07P939	55	DOOR TRIM KIT SMOOTH
DSKD07P939K	55	DOOR TRIM KIT SMOOTH
DSKD07P9612	55	DOOR TRIM KIT SMOOTH
DSKD07P9612K	55	DOOR TRIM KIT SMOOTH
DSKD08F969	57	DOOR TRIM KIT SMOOTH
DSKD08F969K	57	DOOR TRIM KIT SMOOTH
DSKD08F9612	57	DOOR TRIM KIT SMOOTH
DSKD08F9612K	57	DOOR TRIM KIT SMOOTH
DSKD08P969	55	DOOR TRIM KIT SMOOTH
DSKD08P969K	55	DOOR TRIM KIT SMOOTH
DSKD08P9612	55	DOOR TRIM KIT SMOOTH
DSKD08P9612K	55	DOOR TRIM KIT SMOOTH
DSKS05F516	56	DOOR TRIM KIT SMOOTH
DSKS05F516K	56	DOOR TRIM KIT SMOOTH
DSKS05P516	54	DOOR TRIM KIT SMOOTH

PART NUMBER	PAGE	DESCRIPTION
DSKS05P516K	54	DOOR TRIM KIT SMOOTH
DSKS07F569	56	DOOR TRIM KIT SMOOTH
DSKS07F569K	56	DOOR TRIM KIT SMOOTH
DSKS07F5612	56	DOOR TRIM KIT SMOOTH
DSKS07F5612K	56	DOOR TRIM KIT SMOOTH
DSKS07P569	54	DOOR TRIM KIT SMOOTH
DSKS07P569K	54	DOOR TRIM KIT SMOOTH
DSKS07P5612	54	DOOR TRIM KIT SMOOTH
DSKS07P5612K	54	DOOR TRIM KIT SMOOTH
DSKS08F589	56	DOOR TRIM KIT SMOOTH
DSKS08F589K	56	DOOR TRIM KIT SMOOTH
DSKS08F6412	56	DOOR TRIM KIT SMOOTH
DSKS08F6412K	56	DOOR TRIM KIT SMOOTH
DSKS08P589	54	DOOR TRIM KIT SMOOTH
DSKS08P589K	54	DOOR TRIM KIT SMOOTH
DSKS08P6412	54	DOOR TRIM KIT SMOOTH
DSKS08P6412K	54	DOOR TRIM KIT SMOOTH
DSKS105F646	56	DOOR TRIM KIT SMOOTH
DSKS105F646K	56	DOOR TRIM KIT SMOOTH
DSKS105F666	56	DOOR TRIM KIT SMOOTH
DSKS105F666K	56	DOOR TRIM KIT SMOOTH
DSKS105P646	54	DOOR TRIM KIT SMOOTH
DSKS105P646K	54	DOOR TRIM KIT SMOOTH
DSKS105P666	54	DOOR TRIM KIT SMOOTH
DSKS105P666K	54	DOOR TRIM KIT SMOOTH
DSKS107F679	56	DOOR TRIM KIT SMOOTH
DSKS107F679K	56	DOOR TRIM KIT SMOOTH
DSKS107F689	56	DOOR TRIM KIT SMOOTH
DSKS107F689K	56	DOOR TRIM KIT SMOOTH
DSKS107P679	54	DOOR TRIM KIT SMOOTH
DSKS107P679K	54	DOOR TRIM KIT SMOOTH
DSKS107P689	54	DOOR TRIM KIT SMOOTH
DSKS107P689K	54	DOOR TRIM KIT SMOOTH
DSKS108F699	56	DOOR TRIM KIT SMOOTH
DSKS108F699K	56	DOOR TRIM KIT SMOOTH
DSKS108F709	56	DOOR TRIM KIT SMOOTH
DSKS108F709K	56	DOOR TRIM KIT SMOOTH
DSKS108P699	54	DOOR TRIM KIT SMOOTH
DSKS108P699K	54	DOOR TRIM KIT SMOOTH
DSKS108P709	54	DOOR TRIM KIT SMOOTH
DSKS108P709K	54	DOOR TRIM KIT SMOOTH
DSKS15F676	56	DOOR TRIM KIT SMOOTH
DSKS15F676K	56	DOOR TRIM KIT SMOOTH
DSKS15P676	54	DOOR TRIM KIT SMOOTH
DSKS15P676K	54	DOOR TRIM KIT SMOOTH
DSKS17F709	56	DOOR TRIM KIT SMOOTH
DSKS17F709K	56	DOOR TRIM KIT SMOOTH
DSKS17F7212	56	DOOR TRIM KIT SMOOTH
DSKS17F7212K	56	DOOR TRIM KIT SMOOTH
DSKS17P709	54	DOOR TRIM KIT SMOOTH
DSKS17P709K	54	DOOR TRIM KIT SMOOTH
DSKS17P7212	54	DOOR TRIM KIT SMOOTH
DSKS17P7212K	54	DOOR TRIM KIT SMOOTH
DSKS18F729	56	DOOR TRIM KIT SMOOTH
DSKS18F729K	56	DOOR TRIM KIT SMOOTH
DSKS18F7212	56	DOOR TRIM KIT SMOOTH
DSKS18F7212K	56	DOOR TRIM KIT SMOOTH

PART NUMBER	PAGE	DESCRIPTION
DSKS18P729	54	DOOR TRIM KIT SMOOTH
DSKS18P729K	54	DOOR TRIM KIT SMOOTH
DSKS18P7212	54	DOOR TRIM KIT SMOOTH
DSKS18P7212K	54	DOOR TRIM KIT SMOOTH
DSKS205F746	57	DOOR TRIM KIT SMOOTH
DSKS205F746K	57	DOOR TRIM KIT SMOOTH
DSKS205F786	57	DOOR TRIM KIT SMOOTH
DSKS205F786K	57	DOOR TRIM KIT SMOOTH
DSKS205P746	55	DOOR TRIM KIT SMOOTH
DSKS205P746K	55	DOOR TRIM KIT SMOOTH
DSKS205P786	55	DOOR TRIM KIT SMOOTH
DSKS205P786K	55	DOOR TRIM KIT SMOOTH
DSKS207F779	57	DOOR TRIM KIT SMOOTH
DSKS207F779K	57	DOOR TRIM KIT SMOOTH
DSKS207F819	57	DOOR TRIM KIT SMOOTH
DSKS207F819K	57	DOOR TRIM KIT SMOOTH
DSKS207P779	55	DOOR TRIM KIT SMOOTH
DSKS207P779K	55	DOOR TRIM KIT SMOOTH
DSKS207P819	55	DOOR TRIM KIT SMOOTH
DSKS207P819K	55	DOOR TRIM KIT SMOOTH
DSKS208F809	57	DOOR TRIM KIT SMOOTH
DSKS208F809K	57	DOOR TRIM KIT SMOOTH
DSKS208F849	57	DOOR TRIM KIT SMOOTH
DSKS208F849K	57	DOOR TRIM KIT SMOOTH
DSKS208P809	55	DOOR TRIM KIT SMOOTH
DSKS208P809K	55	DOOR TRIM KIT SMOOTH
DSKS208P849	55	DOOR TRIM KIT SMOOTH
DSKS208P849K	55	DOOR TRIM KIT SMOOTH
DSKS25F846	57	DOOR TRIM KIT SMOOTH
DSKS25F846K	57	DOOR TRIM KIT SMOOTH
DSKS25P846	55	DOOR TRIM KIT SMOOTH
DSKS25P846K	55	DOOR TRIM KIT SMOOTH
DSKS27F869	57	DOOR TRIM KIT SMOOTH
DSKS27F869K	57	DOOR TRIM KIT SMOOTH
DSKS27F9612	57	DOOR TRIM KIT SMOOTH
DSKS27F9612K	57	DOOR TRIM KIT SMOOTH
DSKS27P869	55	DOOR TRIM KIT SMOOTH
DSKS27P869K	55	DOOR TRIM KIT SMOOTH
DSKS27P9612	55	DOOR TRIM KIT SMOOTH
DSKS27P9612K	55	DOOR TRIM KIT SMOOTH
DSKS28F889	57	DOOR TRIM KIT SMOOTH
DSKS28F889K	57	DOOR TRIM KIT SMOOTH
DSKS28F9612	57	DOOR TRIM KIT SMOOTH
DSKS28F9612K	57	DOOR TRIM KIT SMOOTH
DSKS28P889	55	DOOR TRIM KIT SMOOTH
DSKS28P889K	55	DOOR TRIM KIT SMOOTH
DSKS28P9612	55	DOOR TRIM KIT SMOOTH
DSKS28P9612K	55	DOOR TRIM KIT SMOOTH
DTLB3X3X3	141	DENTIL BLOCK SMOOTH
DTLB3X3X4	145	DENTIL BLOCK SMOOTH
DTLB3X5X6	143	DENTIL BLOCK SMOOTH
DTLB3.5X3.5X7	141	DENTIL BLOCK SMOOTH
DTLB3.5X5.5X5.5	145	DENTIL BLOCK SMOOTH
DTLB4X4X4	145	DENTIL BLOCK SMOOTH
DTLB4X4X7	143	DENTIL BLOCK SMOOTH
DTLB4X4X9	143	DENTIL BLOCK SMOOTH
DTLB4X5X7	145	DENTIL BLOCK SMOOTH

PART NUMBER	PAGE	DESCRIPTION
DTLB4X5X8	142	DENTIL BLOCK SMOOTH
DTLB4X6X6	143	DENTIL BLOCK SMOOTH
DTLB4X6X7	144	DENTIL BLOCK SMOOTH
DTLB4X6X9	141	DENTIL BLOCK SMOOTH
DTLB5X4X7	144	DENTIL BLOCK SMOOTH
DTLB5X5X3	141	DENTIL BLOCK SMOOTH
DTLB5X6X6	141	DENTIL BLOCK SMOOTH
DTLB5X6X8	141	DENTIL BLOCK SMOOTH
DTLB5X6X10	142	DENTIL BLOCK SMOOTH
DTLB5X6X11	144	DENTIL BLOCK SMOOTH
DTLB5X6X18	141	DENTIL BLOCK SMOOTH
DTLB5X8	143	DENTIL BLOCK SMOOTH
DTLB5X8X10	144	DENTIL BLOCK SMOOTH
DTLB6X4X6	144	DENTIL BLOCK SMOOTH
DTLB6X4X6L12	145	DENTIL BLOCK SMOOTH
DTLB6X4X6R12	145	DENTIL BLOCK SMOOTH
DTLB6X5X7	144	DENTIL BLOCK SMOOTH
DTLB6X6X5	144	DENTIL BLOCK SMOOTH
DTLB6X6X8	144	DENTIL BLOCK SMOOTH
DTLB6X6X9	143	DENTIL BLOCK SMOOTH
DTLB6X6X9.25	144	DENTIL BLOCK SMOOTH
DTLB6X7X9	143	DENTIL BLOCK SMOOTH
DTLB6X9X7	142	DENTIL BLOCK SMOOTH
DTLB8X6X6	145	DENTIL BLOCK SMOOTH
DTLB9X11X16	143	DENTIL BLOCK SMOOTH
DTLB9X8X8	143	DENTIL BLOCK SMOOTH
DVP40	42	PEDIMENT DLX VICTORIAN SMOOTH
E		
EBLV12X24	185	EYEBROW LOUVER DECO SMOOTH
EBLV18X30	185	EYEBROW LOUVER DECO SMOOTH
EBLV22X32	185	EYEBROW LOUVER DECO SMOOTH
ESWDH76X23	34	PEDIMENT ELLIPTICAL SUNBURST W/DECO TRIM SMOOTH
EV404	115	E-VENT CROWN DENTIL
EV404B	115	E-VENT JOINING BLOCK/END CAP
EV404MI	115	E-VENT MITERED INSIDE CORNER
EV404MO	115	E-VENT MITERED OUTSIDE CORNER
EV570	116	E-VENT COMBINATION CROWN
EV570B	116	E-VENT JOINING BLOCK/END CAP
EV570MI	116	E-VENT MITERED INSIDE CORNER
EV570MO	116	E-VENT MITERED OUTSIDE CORNER
EV580	117	E-VENT MASSIVE CROWN
EV580B	117	E-VENT JOINING BLOCK/END CAP
EV580MI	117	E-VENT MITERED INSIDE CORNER
EV580MO	117	E-VENT MITERED OUTSIDE CORNER
EVFB	115, 116, 117	E-VENT FILLER BLOCK
F		
F100	141	DENTIL BLOCK SMOOTH
FCLV12X24	184	LOUVER FUNC CATHEDRAL SMOOTH
FCLV14X22	184	LOUVER FUNC CATHEDRAL SMOOTH
FCLV16X36	184	LOUVER FUNC CATHEDRAL SMOOTH
FCLV18X24	184	LOUVER FUNC CATHEDRAL SMOOTH
FCLV18X30	184	LOUVER FUNC CATHEDRAL SMOOTH
FCLV18X54	184	LOUVER FUNC CATHEDRAL SMOOTH
FCLV22X31	184	LOUVER FUNC CATHEDRAL SMOOTH
FCLV24X48	184	LOUVER FUNC CATHEDRAL SMOOTH
FCLV28X43	184	LOUVER FUNC CATHEDRAL SMOOTH
FCLV36X48	184	LOUVER FUNC CATHEDRAL SMOOTH

PART NUMBER	PAGE	DESCRIPTION
<b>FDLV24X24</b>	197	LOUVER FUNC DIAMOND SMOOTH
<b>FEBLV12X24</b>	185	LOUVER FUNC EYEBROW SMOOTH
<b>FEBLV18X30</b>	185	LOUVER FUNC EYEBROW SMOOTH
<b>FEBLV22X32</b>	185	LOUVER FUNC EYEBROW SMOOTH
<b>FHRLV24X12</b>	190	LOUVER FUNC HALF ROUND SMOOTH
<b>FHRLV28X14</b>	190	LOUVER FUNC HALF ROUND SMOOTH
<b>FHRLV29-6FKWD</b>	191	LOUVER FUNC HALF ROUND W/DECO T,D,K SMOOTH
<b>FHRLV32X16</b>	190	LOUVER FUNC HALF ROUND SMOOTH
<b>FHRLV36X18</b>	190	LOUVER FUNC HALF ROUND SMOOTH
<b>FHRLV36X18-4F</b>	191	LOUVER FUNC HALF ROUND W/ FL TRIM SMOOTH
<b>FHRLV36X18-6F</b>	191	LOUVER FUNC HALF ROUND W/ FL TRIM SMOOTH
<b>FHRLV36X18MTK</b>	191	LOUVER FUNC HALF ROUND W/DECO T,K SMOOTH
<b>FHRLV40X20</b>	190	LOUVER FUNC HALF ROUND SMOOTH
<b>FHRLV42X21</b>	190	LOUVER FUNC HALF ROUND SMOOTH
<b>FHRLV48X24</b>	190	LOUVER FUNC HALF ROUND SMOOTH
<b>FHRLV60X30</b>	190	LOUVER FUNC HALF ROUND SMOOTH
<b>FHRLV72X36</b>	190	LOUVER FUNC HALF ROUND SMOOTH
<b>FLT1X3-12</b>	59, 82	FLAT TRIM, RAIL SHAKER SHUTTER
<b>FLT1X4-12RS</b>	77, 85	BATTEN, TIMBER TEXTURE
<b>FLT9X4X216S</b>	85	FLAT TRIM, TIMBER TEXTURE
<b>FLT30X228X1S</b>	85	FLAT TRIM, TIMBER TEXTURE
<b>FLT40X96</b>	52, 81	WINDOW PANEL FLAT SMOOTH
<b>FLT100-12</b>	82	FLAT TRIM SMOOTH
<b>FLT101-12</b>	82	FLAT TRIM SMOOTH
<b>FLT102-10</b>	82	FLAT TRIM SMOOTH
<b>FLT103-12</b>	82	FLAT TRIM SMOOTH
<b>FLT109-12</b>	82	FLAT TRIM SMOOTH
<b>FLT110-12S</b>	85	FLAT TRIM, TIMBER TEXTURE
<b>FLT110-16</b>	80	FLAT TRIM SMOOTH
<b>FLT111-12S</b>	85	FLAT TRIM, TIMBER TEXTURE
<b>FLT113-8</b>	82	FLAT TRIM SMOOTH
<b>FLT118-8</b>	82	FLAT TRIM SMOOTH
<b>FLT119-17</b>	83	FLAT TRIM SMOOTH
<b>FLT122-16</b>	82	FLAT TRIM SMOOTH
<b>FLT125-8</b>	83	FLAT TRIM SMOOTH
<b>FLT131-16</b>	82	FLAT TRIM SMOOTH
<b>FLT150-12S</b>	85	FLAT TRIM, TIMBER TEXTURE
<b>FLT151-12S</b>	85	FLAT TRIM, TIMBER TEXTURE
<b>FLT152-12</b>	82	FLAT TRIM SMOOTH
<b>FLT152-16</b>	82	FLAT TRIM SMOOTH
<b>FLT152-8</b>	82	FLAT TRIM SMOOTH
<b>FLT153-12</b>	82	FLAT TRIM SMOOTH
<b>FLT159-12</b>	82	FLAT TRIM SMOOTH
<b>FLT159-16</b>	82	FLAT TRIM SMOOTH
<b>FLT159-8</b>	82	FLAT TRIM SMOOTH
<b>FLT162-14</b>	82	FLAT TRIM SMOOTH
<b>FLT162-8</b>	82	FLAT TRIM SMOOTH
<b>FLT163-16</b>	83	FLAT TRIM SMOOTH
<b>FLT170-12</b>	82	FLAT TRIM SMOOTH
<b>FLT170-16</b>	82	FLAT TRIM SMOOTH
<b>FLT172-16</b>	82	FLAT TRIM SMOOTH
<b>FLT173-12S</b>	85	FLAT TRIM, TIMBER TEXTURE
<b>FLT175-12</b>	83	FLAT TRIM SMOOTH
<b>FLT178-8</b>	83	FLAT TRIM SMOOTH
<b>FLT179-12</b>	81	FLAT TRIM SMOOTH
<b>FLT180-12</b>	83	FLAT TRIM SMOOTH
<b>FLT181-8</b>	82	FLAT TRIM SMOOTH

PART NUMBER	PAGE	DESCRIPTION
<b>FLT182-12</b>	83	FLAT TRIM SMOOTH
<b>FLT183-12</b>	83	FLAT TRIM SMOOTH
<b>FLT185-12</b>	83	FLAT TRIM SMOOTH
<b>FLT186-16</b>	82	FLAT TRIM SMOOTH
<b>FLT187-12S</b>	85	FLAT TRIM, TIMBER TEXTURE
<b>FLT190-12</b>	83	FLAT TRIM SMOOTH
<b>FLT192-12S</b>	85	FLAT TRIM, TIMBER TEXTURE
<b>FLT194-10</b>	83	FLAT TRIM SMOOTH
<b>FLT197-12S</b>	85	FLAT TRIM, TIMBER TEXTURE
<b>FLTBA36X3X3S</b>	161	LATTICE, TIMBER TEXTURE
<b>FLTBA36X3X3</b>	160	TRELLIS LATTICE SMOOTH
<b>FLV12X18</b>	186	LOUVER FUNC RECT VERT SMOOTH
<b>FLV12X24</b>	186	LOUVER FUNC RECT VERT SMOOTH
<b>FLV12X30</b>	186	LOUVER FUNC RECT VERT SMOOTH
<b>FLV12X36</b>	186	LOUVER FUNC RECT VERT SMOOTH
<b>FLV12X40</b>	186	LOUVER FUNC RECT VERT SMOOTH
<b>FLV14X27</b>	186	LOUVER FUNC RECT VERT SMOOTH
<b>FLV14X30</b>	186	LOUVER FUNC RECT VERT SMOOTH
<b>FLV14X32</b>	186	LOUVER FUNC RECT VERT SMOOTH
<b>FLV16X24</b>	186	LOUVER FUNC RECT VERT SMOOTH
<b>FLV16X36</b>	186	LOUVER FUNC RECT VERT SMOOTH
<b>FLV18X24</b>	186	LOUVER FUNC RECT VERT SMOOTH
<b>FLV18X24-4F6WCH</b>	188	LOUVER FUNC RECT VERT W/TRIM & CRSHD SMOOTH
<b>FLV18X30</b>	186	LOUVER FUNC RECT VERT SMOOTH
<b>FLV18X36</b>	186	LOUVER FUNC RECT VERT SMOOTH
<b>FLV18X42</b>	186	LOUVER FUNC RECT VERT SMOOTH
<b>FLV20X28</b>	186	LOUVER FUNC RECT VERT SMOOTH
<b>FLV24X24</b>	186	LOUVER FUNC RECT VERT SMOOTH
<b>FLV24X30</b>	186	LOUVER FUNC RECT VERT SMOOTH
<b>FLV24X36</b>	186	LOUVER FUNC RECT VERT SMOOTH
<b>FLV24X48</b>	186	LOUVER FUNC RECT VERT SMOOTH
<b>FLV27X17</b>	189	LOUVER FUNC RECT VERT SMOOTH
<b>FLV30X42</b>	186	LOUVER FUNC RECT VERT SMOOTH
<b>FLV32X16</b>	189	LOUVER FUNC RECT VERT SMOOTH
<b>FLV8X15</b>	186	LOUVER FUNC RECT VERT SMOOTH
<b>FLV8X24</b>	186	LOUVER FUNC RECT VERT SMOOTH
<b>FLV8X30</b>	186	LOUVER FUNC RECT VERT SMOOTH
<b>FLVNS18X24</b>	188	LOUVER FUNC RECT VERT NO SILL SMOOTH
<b>FM8X12X2</b>	163	FIXTURE MOUNT SMOOTH
<b>FMS8X8X2</b>	163	FIXTURE MOUNT SMOOTH
<b>FOLV18</b>	197	LOUVER FUNC OCTAGON SMOOTH
<b>FOLV22</b>	197	LOUVER FUNC OCTAGON SMOOTH
<b>FOLV24</b>	197	LOUVER FUNC OCTAGON SMOOTH
<b>FOLV28</b>	197	LOUVER FUNC OCTAGON SMOOTH
<b>FOVL28X35K215V</b>	195	LOUVER FUNC OVAL VERT W/ DC TRIM & KEY SMOOTH
<b>FOVL35X28K215</b>	195	LOUVER FUNC OVAL HORZ W/ DC TRIM & KEY SMOOTH
<b>FOVLV18X24V</b>	194	LOUVER FUNC OVAL VERT SMOOTH
<b>FOVLV20X29VTK</b>	195	LOUVER FUNC OVAL VERT W/ FL TRIM & KEY SMOOTH
<b>FOVLV25X37V</b>	194	LOUVER FUNC OVAL VERT SMOOTH
<b>FP12X96</b>	48	FLUTED PANEL TRIM SMOOTH
<b>FP9X168</b>	48	FLUTED PANEL TRIM SMOOTH
<b>FPLV18X24-8</b>	185	LOUVER FUNC PEAKED SMOOTH
<b>FPLV18X36-10</b>	185	LOUVER FUNC PEAKED SMOOTH
<b>FPLV24X30-10</b>	185	LOUVER FUNC PEAKED SMOOTH
<b>FPLV24X36-10</b>	185	LOUVER FUNC PEAKED SMOOTH
<b>FPLV24X36-12</b>	185	LOUVER FUNC PEAKED SMOOTH
<b>FRLV12</b>	192	LOUVER FUNC ROUND SMOOTH

PART NUMBER	PAGE	DESCRIPTION
<b>FRLV16</b>	192	LOUVER FUNC ROUND SMOOTH
<b>FRLV16MTK</b>	193	LOUVER FUNC ROUND W/ DC TRIM & KEY SMOOTH
<b>FRLV18</b>	192	LOUVER FUNC ROUND SMOOTH
<b>FRLV18MTK</b>	193	LOUVER FUNC ROUND W/ DC TRIM & KEY SMOOTH
<b>FRLV22</b>	192	LOUVER FUNC ROUND SMOOTH
<b>FRLV24</b>	192	LOUVER FUNC ROUND SMOOTH
<b>FRLV24-4FTK</b>	193	LOUVER FUNC ROUND W/ DC TRIM & KEY SMOOTH
<b>FRLV24-6TK</b>	193	LOUVER FUNC ROUND W/ FL TRIM & FLAT KEY SMOOTH
<b>FRLV24MTK</b>	193	LOUVER FUNC ROUND W/ DC TRIM & KEY SMOOTH
<b>FRLV24TK</b>	194	LOUVER FUNC ROUND W/ FL TRIM & FLAT KEY SMOOTH
<b>FRLV28</b>	192	LOUVER FUNC ROUND SMOOTH
<b>FRLV30</b>	192	LOUVER FUNC ROUND SMOOTH
<b>FRLV30-6TK</b>	193	LOUVER FUNC ROUND W/ FL TRIM & FLAT KEY SMOOTH
<b>FRLV30MTK</b>	193	LOUVER FUNC ROUND W/ DC TRIM & KEY SMOOTH
<b>FRLV30TK</b>	194	LOUVER FUNC ROUND W/ FL TRIM & FLAT KEY SMOOTH
<b>FRLV32-2F</b>	192	LOUVER FUNC ROUND W/ FL TRIM SMOOTH
<b>FRLV32MTK</b>	193	LOUVER FUNC ROUND W/ DC TRIM & KEY SMOOTH
<b>FRLV32TK</b>	194	LOUVER FUNC ROUND W/ FL TRIM & KEY SMOOTH
<b>FRLV36</b>	192	LOUVER FUNC ROUND SMOOTH
<b>FRLV36TK</b>	194	LOUVER FUNC ROUND W/ FL TRIM & FK SMOOTH
<b>FRLV40MTK</b>	193	LOUVER FUNC ROUND W/ DC TRIM & KEY SMOOTH
<b>FRLV42</b>	192	LOUVER FUNC ROUND SMOOTH
<b>FRLV48</b>	192	LOUVER FUNC ROUND SMOOTH
<b>FSR103X17</b>	163	FISHSCALE PANEL SMOOTH
<b>FTRLV36X18</b>	196	LOUVER FUNC TRIANGLE SMOOTH
<b>FTRLV42X21</b>	196	LOUVER FUNC TRIANGLE SMOOTH
<b>FTRLV48X12</b>	196	LOUVER FUNC TRIANGLE SMOOTH
<b>FTRLV48X18</b>	196	LOUVER FUNC TRIANGLE SMOOTH
<b>FTRLV48X22</b>	196	LOUVER FUNC TRIANGLE SMOOTH
<b>FTRLV48X24</b>	196	LOUVER FUNC TRIANGLE SMOOTH
<b>FTRLV60X18</b>	196	LOUVER FUNC TRIANGLE SMOOTH
<b>FTRLV60X23</b>	196	LOUVER FUNC TRIANGLE SMOOTH
<b>FTRLV60X25</b>	196	LOUVER FUNC TRIANGLE SMOOTH
<b>FTRLV60X30</b>	196	LOUVER FUNC TRIANGLE SMOOTH
<b>FTRLV64X27</b>	196	LOUVER FUNC TRIANGLE SMOOTH
<b>FTRLV64X32</b>	196	LOUVER FUNC TRIANGLE SMOOTH
<b>FTRLV66X22</b>	196	LOUVER FUNC TRIANGLE SMOOTH
<b>FTRLV72X36</b>	196	LOUVER FUNC TRIANGLE SMOOTH
<b>FTRLV76X19</b>	196	LOUVER FUNC TRIANGLE SMOOTH
<b>FTRLV84X18</b>	196	LOUVER FUNC TRIANGLE SMOOTH
<b>FTRLV84X21</b>	196	LOUVER FUNC TRIANGLE SMOOTH
<b>FTRLV88X22</b>	196	LOUVER FUNC TRIANGLE SMOOTH
<b>FTRLVLR60X25</b>	197	LOUVER FUNC 2PC TRIANGLE SMOOTH
<b>FTRLVLR60X30</b>	197	LOUVER FUNC 2PC TRIANGLE SMOOTH
<b>FTRLVLR108X27</b>	197	LOUVER FUNC 2PC TRIANGLE SMOOTH
<b>FTRLVLR115X35</b>	197	LOUVER FUNC 2PC TRIANGLE SMOOTH
<b>FTRLVLR120X30</b>	197	LOUVER FUNC 2PC TRIANGLE SMOOTH
<b>G</b>		
<b>GP60X36</b>	158	GABLE PEDIMENT VICTORIAN SMOOTH
<b>GP64X32</b>	158	GABLE PEDIMENT VICTORIAN SMOOTH
<b>GP80X33</b>	158	GABLE PEDIMENT VICTORIAN SMOOTH
<b>GP81X31</b>	158	GABLE PEDIMENT VICTORIAN SMOOTH
<b>GP88X29</b>	158	GABLE PEDIMENT VICTORIAN SMOOTH
<b>GP96X28</b>	158	GABLE PEDIMENT VICTORIAN SMOOTH
<b>GP107X22</b>	158	GABLE PEDIMENT VICTORIAN SMOOTH
<b>GP110X27</b>	158	GABLE PEDIMENT VICTORIAN SMOOTH
<b>GPA70X35</b>	158	GABLE PEDIMENT ARCHED SMOOTH

PART NUMBER	PAGE	DESCRIPTION
<b>GPA81X34</b>	158	GABLE PEDIMENT ARCHED SMOOTH
<b>GPA86X32</b>	158	GABLE PEDIMENT ARCHED SMOOTH
<b>GPA87X29</b>	158	GABLE PEDIMENT ARCHED SMOOTH
<b>GPA95X28</b>	158	GABLE PEDIMENT ARCHED SMOOTH
<b>GPA104X26</b>	158	GABLE PEDIMENT ARCHED SMOOTH
<b>GPF66X33</b>	159	GABLE PEDIMENT FLAT SMOOTH
<b>GPK100</b>	159	GABLE PEDIMENT BASIC SMOOTH
<b>GPK401</b>	159	GABLE PEDIMENT STEWART SMOOTH
<b>GPK451</b>	159	GABLE PEDIMENT STEWART CENTER SMOOTH
<b>GPK801</b>	159	GABLE PEDIMENT STEWART SMOOTH
<b>GPK851</b>	159	GABLE PEDIMENT STEWART CENTER SMOOTH
<b>H</b>		
<b>HRCBCC96X12ST</b>	223	COLUMN SET, STONE TEXTURE
<b>HRLV24X12</b>	190	HALF ROUND LOUVER DECO SMOOTH
<b>HRLV28X14</b>	190	HALF ROUND LOUVER DECO SMOOTH
<b>HRLV29-6FKWD</b>	191	LOUVER DECO HALF ROUND W/DECO T,D,K SMOOTH
<b>HRLV32X16</b>	190	HALF ROUND LOUVER DECO SMOOTH
<b>HRLV36X18</b>	190	HALF ROUND LOUVER DECO SMOOTH
<b>HRLV36X18-4F</b>	191	HALF ROUND W/ FL TRIM LOUVER DECO SMOOTH
<b>HRLV36X18-6F</b>	191	HALF ROUND W/ FL TRIM LOUVER DECO SMOOTH
<b>HRLV36X18MTK</b>	191	LOUVER DECO HALF ROUND W/ DC TRIM & KEY SMOOTH
<b>HRLV40X20</b>	190	HALF ROUND LOUVER DECO SMOOTH
<b>HRLV42X21</b>	190	HALF ROUND LOUVER DECO SMOOTH
<b>HRLV48X24</b>	190	HALF ROUND LOUVER DECO SMOOTH
<b>HRLV60X30</b>	190	HALF ROUND LOUVER DECO SMOOTH
<b>HRLV72X36</b>	190	HALF ROUND LOUVER DECO SMOOTH
<b>HRSPP36X18</b>	34	PEDIMENT HALF ROUND SPKD SMOOTH
<b>HRSPP48X24</b>	34	PEDIMENT HALF ROUND SPKD SMOOTH
<b>HRSPP72X36</b>	34	PEDIMENT HALF ROUND SPKD SMOOTH
<b>K</b>		
<b>K4TF</b>	53	KEYSTONE TRIM PROFILE SMOOTH
<b>K4TM</b>	53	KEYSTONE TRIM PROFILE SMOOTH
<b>K6</b>	53	KEYSTONE SOLID SMOOTH
<b>K6M</b>	18,53	KEYSTONE CROSSHEAD PROFILE SMOOTH
<b>K6TF</b>	53	KEYSTONE TRIM PROFILE SMOOTH
<b>K6TM</b>	53	KEYSTONE TRIM PROFILE SMOOTH
<b>K8</b>	53	KEYSTONE SOLID SMOOTH
<b>K8TF</b>	53	KEYSTONE TRIM PROFILE SMOOTH
<b>K9M</b>	18,53	KEYSTONE CROSSHEAD PROFILE SMOOTH
<b>K10SEG</b>	53	KEYSTONE CROSSHEAD PROFILE SMOOTH
<b>K10TM</b>	53	KEYSTONE TRIM PROFILE SMOOTH
<b>K12M</b>	53	KEYSTONE CROSSHEAD PROFILE SMOOTH
<b>KCCA10</b>	53	KEYSTONE CROSSHEAD PROFILE SMOOTH
<b>KP4TF</b>	53	KEYSTONE TRIM PROFILE SMOOTH
<b>KP4TM</b>	53	KEYSTONE TRIM PROFILE SMOOTH
<b>KP6M</b>	53	KEYSTONE CROSSHEAD PROFILE SMOOTH
<b>KP6TF</b>	53	KEYSTONE TRIM PROFILE SMOOTH
<b>KP6TM</b>	53	KEYSTONE TRIM PROFILE SMOOTH
<b>KP9M</b>	53	KEYSTONE CROSSHEAD PROFILE SMOOTH
<b>KWM180M</b>	53	KEYSTONE BRICK MOULD PROFILE SMOOTH
<b>L</b>		
<b>LDCH58X18</b>	33	CROSSHEAD LARGE DOOR SMOOTH
<b>LDCH62X18</b>	33	CROSSHEAD LARGE DOOR SMOOTH
<b>LDCH87X18</b>	33	CROSSHEAD LARGE DOOR SMOOTH
<b>LDCH90X18</b>	33	CROSSHEAD LARGE DOOR SMOOTH
<b>LDCH94X18</b>	33	CROSSHEAD LARGE DOOR SMOOTH
<b>LP6X96</b>	219	LAMP POST TAPERED SMOOTH



PART NUMBER	PAGE	DESCRIPTION
LV12X18	186	RECTANGLE VERTICAL LOUVER DECO SMOOTH
LV12X24	186	RECTANGLE VERTICAL LOUVER DECO SMOOTH
LV12X30	186	RECTANGLE VERTICAL LOUVER DECO SMOOTH
LV12X36	186	RECTANGLE VERTICAL LOUVER DECO SMOOTH
LV12X40	186	RECTANGLE VERTICAL LOUVER DECO SMOOTH
LV14X27	186	RECTANGLE VERTICAL LOUVER DECO SMOOTH
LV14X30	186	RECTANGLE VERTICAL LOUVER DECO SMOOTH
LV14X32	186	RECTANGLE VERTICAL LOUVER DECO SMOOTH
LV16X24	186	RECTANGLE VERTICAL LOUVER DECO SMOOTH
LV16X36	186	RECTANGLE VERTICAL LOUVER DECO SMOOTH
LV18X24	186	RECTANGLE VERTICAL LOUVER DECO SMOOTH
LV18X24-4F6WCH	188	LOUVER DECO RECT VRTCL W/TRIM & CRSHD SMOOTH
LV18X30	186	RECTANGLE VERTICAL LOUVER DECO SMOOTH
LV18X30-4F	189	RECTANGLE VERTICAL W/TRIM LOUVER DECO SMOOTH
LV18X36	186	RECTANGLE VERTICAL LOUVER DECO SMOOTH
LV18X42	186	RECTANGLE VERTICAL LOUVER DECO SMOOTH
LV20X28	186	RECTANGLE VERTICAL LOUVER DECO SMOOTH
LV24X24	186	RECTANGLE VERTICAL LOUVER DECO SMOOTH
LV24X30	186	RECTANGLE VERTICAL LOUVER DECO SMOOTH
LV24X36	186	RECTANGLE VERTICAL LOUVER DECO SMOOTH
LV24X48	186	RECTANGLE VERTICAL LOUVER DECO SMOOTH
LV27X17	189	RECTANGLE VERTICAL LOUVER DECO SMOOTH
LV30X42	186	RECTANGLE VERTICAL LOUVER DECO SMOOTH
LV32X16	189	RECTANGLE VERTICAL LOUVER DECO SMOOTH
LV8X15	186	RECTANGLE VERTICAL LOUVER DECO SMOOTH
LV8X24	186	RECTANGLE VERTICAL LOUVER DECO SMOOTH
LV8X30	186	RECTANGLE VERTICAL LOUVER DECO SMOOTH
LVNS18X24	188	RECTANGLE VERTICAL NO SILL LOUVER DECO SMOOTH
LVSH12X36FNCR	60	SHUTTER LOUVERED W/CENTER RAIL SMOOTH
LVSH12X48FNCR	60	SHUTTER LOUVERED W/CENTER RAIL SMOOTH
LVSH16X54FNCR	60	SHUTTER LOUVERED W/CENTER RAIL SMOOTH
LVSH16X60FNCR	60	SHUTTER LOUVERED W/CENTER RAIL SMOOTH
LVSH16X72FNB	61	SHUTTER LOUVERED SMOOTH
LVSH16X72FNCR	60	SHUTTER LOUVERED W/CENTER RAIL SMOOTH
LVSH18X54FNB	61	SHUTTER LOUVERED SMOOTH
LVSH18X60FNB	61	SHUTTER LOUVERED SMOOTH
LVSH18X60FNCR	60	SHUTTER LOUVERED W/CENTER RAIL SMOOTH
LVSH18X66FNCR	60	SHUTTER LOUVERED W/CENTER RAIL SMOOTH
LVSH18X72FNB	61	SHUTTER LOUVERED SMOOTH
LVSH18X72FNCR	60	SHUTTER LOUVERED W/CENTER RAIL SMOOTH
LVSH24X60FNB	61	SHUTTER LOUVERED SMOOTH
LVSH24X60FNCR	60	SHUTTER LOUVERED W/CENTER RAIL SMOOTH
LVSH24X72FNB	61	SHUTTER LOUVERED SMOOTH
LVSH24X72FNCR	60	SHUTTER LOUVERED W/CENTER RAIL SMOOTH
LVSSNN32X144S	76	SHUTTER FAB PANEL, TIMBER TEXTURE, LOUVERED
M		
MLD205-12	108	MOULDING W&D CASING SMOOTH
MLD207-16	108	MOULDING W&D CASING FLUTED SMOOTH
MLD208-16	108	MOULDING W&D CASING FLUTED SMOOTH
MLD214-12	100	MOULDING W&D CASING SMOOTH
MLD215-12	112	MOULDING W&D CASING SMOOTH
MLD220-12	105	MOULDING W&D CASING SMOOTH
MLD220-16	105	MOULDING W&D CASING SMOOTH
MLD221-16	105	MOULDING W&D CASING SMOOTH
MLD221-8	105	MOULDING W&D CASING SMOOTH
MLD224-12	104	MOULDING W&D CASING SMOOTH
MLD226-10	97	MOULDING W&D CASING SMOOTH

PART NUMBER	PAGE	DESCRIPTION
MLD226-12	97	MOULDING W&D CASING SMOOTH
MLD226-16	97	MOULDING W&D CASING SMOOTH
MLD227-16	107	MOULDING W&D CASING SMOOTH
MLD230-16	104	MOULDING W&D CASING SMOOTH
MLD231-12	100	MOULDING W&D CASING SMOOTH
MLD232-16	105	MOULDING W&D CASING SMOOTH
MLD234-16	100	MOULDING W&D CASING SMOOTH
MLD236-16	105	MOULDING W&D CASING SMOOTH
MLD237-16	104	MOULDING W&D CASING SMOOTH
MLD240-8	97	MOULDING CORNICE SMOOTH
MLD245-12	107	MOULDING W&D CASING SMOOTH
MLD246-16	107	MOULDING FASCIA SMOOTH
MLD247-16	107	MOULDING BASE TRIM SMOOTH
MLD250-8	104	MOULDING W&D CASING SMOOTH
MLD250-12	104	MOULDING W&D CASING SMOOTH
MLD253-16	89	MOULDING CROWN FASCIA SMOOTH
MLD303-5	109	MOULDING DENTIL SMOOTH
MLD304-8	109	MOULDING DENTIL SMOOTH
MLD310-12	110	MOULDING DENTIL SMOOTH
MLD310-16	110	MOULDING DENTIL SMOOTH
MLD310-8	110	MOULDING DENTIL SMOOTH
MLD311-16	98	MOULDING CORNICE SMOOTH
MLD313-8	109	MOULDING DENTIL SMOOTH
MLD320-12	110	MOULDING DENTIL SMOOTH
MLD320-16	110	MOULDING DENTIL SMOOTH
MLD320-8	110	MOULDING DENTIL SMOOTH
MLD330-12	108	MOULDING DENTIL SMOOTH
MLD331-16	111	MOULDING DENTIL SMOOTH
MLD332-8	110	MOULDING DENTIL SMOOTH
MLD333-12	111	MOULDING DENTIL SMOOTH
MLD335-12	110	MOULDING DENTIL SMOOTH
MLD336-16	94	MOULDING DENTIL SMOOTH
MLD350-8	109	MOULDING DENTIL SMOOTH
MLD351-8	109	MOULDING DENTIL SMOOTH
MLD352-8	109	MOULDING DENTIL SMOOTH
MLD353-8	110	MOULDING DENTIL SMOOTH
MLD354-12	109	MOULDING DENTIL SMOOTH
MLD355-8	109	MOULDING DENTIL SMOOTH
MLD357-8	18	MOULDING, DENTIL TRIM DISTINCTION CROSSHEAD 6"
MLD358-8	18	MOULDING, DENTIL TRIM DISTINCTION CROSSHEAD 9"
MLD360-8	110	MOULDING DENTIL SMOOTH
MLD362-16	94	MOULDING DENTIL SMOOTH
MLD364-12	90	MOULDING DENTIL SMOOTH
MLD365-16	94	MOULDING DENTIL SMOOTH
MLD370-8	110	MOULDING DENTIL SMOOTH
MLD371-16	90	MOULDING CROWN FASCIA SMOOTH
MLD372-14	92	MOULDING CROWN FASCIA SMOOTH
MLD404-16	94	MOULDING CROWN SMOOTH
MLD406-16	94	MOULDING CROWN SMOOTH
MLD410-12	94	MOULDING CROWN SMOOTH
MLD411-16	94	MOULDING CROWN SMOOTH
MLD412-16	95	MOULDING CROWN SMOOTH
MLD413-12	95	MOULDING CROWN SMOOTH
MLD419-12	95	MOULDING CROWN SMOOTH
MLD421-12	95	MOULDING CROWN SMOOTH
MLD425-12	96	MOULDING CROWN SMOOTH
MLD430-12	94	MOULDING CROWN SMOOTH

PART NUMBER	PAGE	DESCRIPTION
MLD434-16	111	MOULDING DENTIL SMOOTH
MLD435-16	95	MOULDING CROWN SMOOTH
MLD440-12	94	MOULDING CROWN SMOOTH
MLD449-16	87	MOULDING CROWN SMOOTH
MLD450-16	90	MOULDING CROWN SMOOTH
MLD451-16	86	MOULDING CROWN SMOOTH
MLD452-12	86	MOULDING CROWN SMOOTH
MLD453-16	88	MOULDING CROWN SMOOTH
MLD454-12	86	MOULDING CROWN SMOOTH
MLD456-16	86	MOULDING CROWN SMOOTH
MLD457-12	89	MOULDING CROWN SMOOTH
MLD460-12	87	MOULDING CROWN SMOOTH
MLD461-8	95	MOULDING CROWN SMOOTH
MLD467-16	87	MOULDING CROWN SMOOTH
MLD471-12	87	MOULDING CROWN SMOOTH
MLD472-12	99	MOULDING CROWN SMOOTH
MLD480-12	89	MOULDING CROWN SMOOTH
MLD481-12	93	MOULDING CROWN SMOOTH
MLD490-12	96	MOULDING CROWN SMOOTH
MLD493-12	96	MOULDING CROWN SMOOTH
MLD505-8	98	MOULDING FASCIA SMOOTH
MLD506-16	99	MOULDING FASCIA SMOOTH
MLD508-12	98	MOULDING FASCIA SMOOTH
MLD509-16	97	MOULDING CORNICE SMOOTH
MLD510-12	97	MOULDING CORNICE SMOOTH
MLD511-12	97	MOULDING CORNICE SMOOTH
MLD512-16	98	MOULDING CORNICE SMOOTH
MLD513-16	97	MOULDING FASCIA SMOOTH
MLD520-16	98	MOULDING CORNICE SMOOTH
MLD521-8	98	MOULDING FASCIA SMOOTH
MLD522-16	107	MOULDING FASCIA SMOOTH
MLD523-16	97	MOULDING FASCIA SMOOTH
MLD524-16	92	MOULDING CROWN FASCIA SMOOTH
MLD527-16	98	MOULDING CORNICE SMOOTH
MLD528-12	93	MOULDING CROWN SMOOTH
MLD530-8	107	MOULDING FASCIA SMOOTH
MLD531-8	107	MOULDING FASCIA SMOOTH
MLD533-12	99	MOULDING FASCIA SMOOTH
MLD534-12	99	MOULDING CORNICE SMOOTH
MLD535-16	90	MOULDING CROWN SMOOTH
MLD536-12	92	MOULDING CROWN FASCIA SMOOTH
MLD539-16	92	MOULDING CROWN FASCIA SMOOTH
MLD543-12	99	MOULDING FASCIA SMOOTH
MLD545-12	98	MOULDING CORNICE SMOOTH
MLD547-16	98	MOULDING CORNICE SMOOTH
MLD548-16	97	MOULDING FASCIA SMOOTH
MLD552-12	86	MOULDING CROWN FASCIA SMOOTH
MLD555-12	90	MOULDING CROWN SMOOTH
MLD556-16	92	MOULDING CROWN FASCIA SMOOTH
MLD562-8	96	MOULDING CROWN SMOOTH
MLD569-12	89	MOULDING CROWN FASCIA SMOOTH
MLD570-12	88	MOULDING CROWN FASCIA SMOOTH
MLD572-16	84	MOULDING CROWN SMOOTH
MLD758-12	18	MOULDING, BOTTOM TRIM DISTINCTION CROSSHEAD 9"
MLD580-12	92	MOULDING CROWN FASCIA SMOOTH
MLD582-12	89	MOULDING CROWN SMOOTH
MLD583-16	89	MOULDING COVE SMOOTH

PART NUMBER	PAGE	DESCRIPTION
MLD584-16	87	MOULDING COVE SMOOTH
MLD585-12	93	MOULDING CROWN FASCIA SMOOTH
MLD586-16	93	MOULDING CROWN FASCIA SMOOTH
MLD587-16	88	MOULDING CROWN FASCIA SMOOTH
MLD588-16	90	MOULDING COVE SMOOTH
MLD589-16	88	MOULDING COVE SMOOTH
MLD590-16	88	MOULDING COVE SMOOTH
MLD591-16	90	MOULDING COVE SMOOTH
MLD592-16	86	MOULDING COVE SMOOTH
MLD593-16	86	MOULDING COVE SMOOTH
MLD600-10	96	MOULDING FASCIA SMOOTH
MLD601-12	101	MOULDING OGEE SMOOTH
MLD602-8	101	MOULDING OGEE CROSSHEAD TRIM STRIP SMOOTH
MLD603-8	112	MOULDING QUARTER ROUND SMOOTH
MLD605-12	112	MOULDING HALF ROUND SMOOTH
MLD606-12	88	MOULDING COVE SMOOTH
MLD607-8	112	MOULDING CORNER STRIP SMOOTH
MLD610-8	102	MOULDING CHAIR RAIL SMOOTH
MLD611-12	102	MOULDING CHAIR RAIL SMOOTH
MLD612-12	101	MOULDING CHAIR RAIL SMOOTH
MLD613-12	102	MOULDING BED MOULDING SMOOTH
MLD614-16	102	MOULDING CHAIR RAIL SMOOTH
MLD618-16	101	MOULDING BASE CAP SMOOTH
MLD621-16	104	MOULDING SHINGLE SMOOTH
MLD625-16	102	MOULDING STEP SMOOTH
MLD626-8	101	MOULDING BED MOULDING SMOOTH
MLD627-16	101	MOULDING CHAIR RAIL SMOOTH
MLD628-8	112	MOULDING COVE SMOOTH
MLD629-10	102	MOULDING BED MOULDING SMOOTH
MLD631-16	100	MOULDING CHAIR RAIL SMOOTH
MLD633-8	101	MOULDING OGEE SMOOTH
MLD634-16	101	MOULDING OGEE SMOOTH
MLD635-12	90	MOULDING COVE SMOOTH
MLD637-16	100	MOULDING ASTRAGAL/MULLION SMOOTH
MLD639-16	105	MOULDING FASCIA SMOOTH
MLD640-8	96	MOULDING FASCIA SMOOTH
MLD641-16	104	MOULDING CORNICE SMOOTH
MLD642-12	92	MOULDING CROWN SMOOTH
MLD644-16	107	MOULDING FASCIA SMOOTH
MLD649-16	102	MOULDING BED MOULDING SMOOTH
MLD660-10	112	MOULDING COVE SMOOTH
MLD705-16	105	MOULDING FLAT TRIM PROFILES COVE SMOOTH
MLD706-16	102	MOULDING BASE TRIM SMOOTH
MLD710-10	100	MOULDING SILL SMOOTH
MLD715-16	104	MOULDING FLAT TRIM PROFILES BEADED SMOOTH
MLD716-12	18	MOULDING, BOTTOM TRIM DISTINCTION CROSSHEAD 6"
MLD730-8	112	MOULDING OGEE SMOOTH
MLD732-12	96	MOULDING CROWN FASCIA SMOOTH
MLD734-12	92	MOULDING COVE SMOOTH
MLD735-16	105	MOULDING FLAT TRIM PROFILES BEADED SMOOTH
MLD758-12	18	MOULDING, BOTTOM TRIM DISTINCTION CROSSHEAD 9"
MLD1001-12	89	MOULDING CROWN SMOOTH
MLD1002-12	89	MOULDING CROWN SMOOTH
MLD1019-12	104	MOULDING BASE TRIM SMOOTH
MLD1020-12	104	MOULDING BASE TRIM SMOOTH
MLD1037-12	88	MOULDING CROWN SMOOTH
MLDWM180-8	83	BRICKMOULD SMOOTH

PART NUMBER	PAGE	DESCRIPTION
MLDWM180-16	83	BRICKMOULD SMOOTH
MLDWM181-16	83	BRICKMOULD SMOOTH
MLDWM182-12	83	BRICKMOULD SMOOTH
N		
NP10X48	214	NEWEL POST DECO EDGE SMOOTH
NP12X48	215	NEWEL POST PLAIN SMOOTH
NP6X48	214	NEWEL POST PLAIN SMOOTH
NP8X48	214	NEWEL POST PLAIN SMOOTH
NP8X48ST	223	NEWEL POST, STONE TEXTURE
NPCP8X48	214	CORNER PANEL NEWEL POST SMOOTH
NPCP13X48	214	CORNER PANEL NEWEL POST SMOOTH
NPK10	215	NEWEL POST INSTALL KIT
NPK12	215	NEWEL POST INSTALL KIT SMOOTH
NPK13	215	NEWEL POST INSTALL KIT SMOOTH
NPK400	215	NEWEL POST INSTALL KIT SMOOTH
NPK600	215	NEWEL POST INSTALL KIT SMOOTH
NPSP8X48	215	STRAIGHT PANEL NEWEL POST SMOOTH
NPSP13X48	215	STRAIGHT PANEL NEWEL POST SMOOTH
O		
OLV18	197	OCTAGON LOUVER DECO SMOOTH
OLV22	197	OCTAGON LOUVER DECO SMOOTH
OLV24	197	OCTAGON LOUVER DECO SMOOTH
OLV28	197	OCTAGON LOUVER DECO SMOOTH
OV24X36X4F	51	TRIM OVAL FLAT SMOOTH
OV24X36X4M	51	TRIM OVAL DECORATIVE SMOOTH
OVL28X35K215V	195	LOUVER DECO OVAL VRTCL W/ DC TRIM & KEY SMOOTH
OVL35X28K215	195	LOUVER DECO OVAL HORZ W/ DC TRIM & KEY SMOOTH
OVLV18X24V	194	OVAL VERTICAL LOUVER DECO SMOOTH
OVLV20X29VTK	195	LOUVER DECO OVAL VRTCL W/ FL TRIM & KEY SMOOTH
OVLV25X37V	194	OVAL VERTICAL LOUVER DECO SMOOTH
OVLV29X20TK	195	LOUVER DECO OVAL HORZ W/TRIM & KEY SMOOTH
P		
PB2.5X2.5	114	PLINTH BLOCK ROSETTE SMOOTH
PB3X3	114	PLINTH BLOCK ROSETTE SMOOTH
PB3.5X3.5	114	PLINTH BLOCK ROSETTE SMOOTH
PB3.875X3.875	114	PLINTH BLOCK ROSETTE SMOOTH
PB4X4	114	PLINTH BLOCK ROSETTE SMOOTH
PB5X5	114	PLINTH BLOCK ROSETTE SMOOTH
PB6X6	114	PLINTH BLOCK ROSETTE SMOOTH
PCP56	38	PEDIMENT PEAKED CAP SMOOTH
PCP667	38	PEDIMENT PEAKED CAP SMOOTH
PHFR5X11	165	FINIAL FULL RND PINEAPPLE SMOOTH
PHFR6X14	165	FINIAL FULL RND PINEAPPLE SMOOTH
PIL3X81	45	PILASTER FLUTED MLD PLTH SMOOTH
PIL3X108	46	PILASTER FLUTED ADJ PLTH SMOOTH
PIL3X90E	46	PILASTER FLUTED ECO MLD PLTH SMOOTH
PIL4X83	45	PILASTER FLUTED MLD PLTH SMOOTH
PIL4X86	45	PILASTER FLUTED MLD PLTH SMOOTH
PIL4X90	45	PILASTER FLUTED MLD PLTH SMOOTH
PIL4X108	46	PILASTER FLUTED ADJ PLTH SMOOTH
PIL5X82	45	PILASTER FLUTED MLD PLTH SMOOTH
PIL5X90	45	PILASTER FLUTED MLD PLTH SMOOTH
PIL5X90DP	44	PILASTER DOUBLE PANEL MLD PLTH SMOOTH
PIL5X90E	46	PILASTER FLUTED ECO MLD PLTH SMOOTH
PIL5X90P	43	PILASTER PLAIN MLD PLTH SMOOTH
PIL5X108	46	PILASTER FLUTED ADJ PLTH SMOOTH
PIL5X108P	44	PILASTER PLAIN ADJ PLTH SMOOTH

PART NUMBER	PAGE	DESCRIPTION
PIL5X120E	47	PILASTER FLUTED ECO ADJ PLTH SMOOTH
PIL6X90	45	PILASTER FLUTED MLD PLTH SMOOTH
PIL6X90P	43	PILASTER PLAIN MLD PLTH SMOOTH
PIL6X108	46	PILASTER FLUTED ADJ PLTH SMOOTH
PIL6X120P	44	PILASTER PLAIN ADJ PLTH SMOOTH
PIL6X144	46	PILASTER FLUTED ADJ PLTH SMOOTH
PIL7X90	45	PILASTER FLUTED MLD PLTH SMOOTH
PIL7X90DP	44	PILASTER DOUBLE PANEL MLD PLTH SMOOTH
PIL7X90DPE	45	PILASTER DOUBLE PANEL ECO MLD PLTH SMOOTH
PIL7X90E	46	PILASTER FLUTED ECO MLD PLTH SMOOTH
PIL7X90P	43	PILASTER PLAIN MLD PLTH SMOOTH
PIL7X90PE	43	PILASTER DOUBLE PANEL ECO MLD PLTH SMOOTH
PIL7X102	46	PILASTER FLUTED ADJ PLTH SMOOTH
PIL7X108	46	PILASTER FLUTED ADJ PLTH SMOOTH
PIL7X108P	44	PILASTER PLAIN ADJ PLTH SMOOTH
PIL7X120E	47	PILASTER FLUTED ECO ADJ PLTH SMOOTH
PIL7X120P	44	PILASTER PLAIN ADJ PLTH SMOOTH
PIL7X144	46	PILASTER FLUTED ADJ PLTH SMOOTH
PIL8X90	46	PILASTER FLUTED ADJ PLTH SMOOTH
PIL8X90P	43	PILASTER PLAIN MLD PLTH SMOOTH
PIL8X108	46	PILASTER FLUTED ADJ PLTH SMOOTH
PIL8X108P	44	PILASTER PLAIN ADJ PLTH SMOOTH
PIL8X144	46	PILASTER FLUTED ADJ PLTH SMOOTH
PIL9X90	45	PILASTER FLUTED MLD PLTH SMOOTH
PIL9X90DP	44	PILASTER DOUBLE PANEL MLD PLTH SMOOTH
PIL9X90E	46	PILASTER FLUTED ECO MLD PLTH SMOOTH
PIL9X90P	43	PILASTER PLAIN MLD PLTH SMOOTH
PIL9X100DP	44	PILASTER DOUBLE PANEL MLD PLTH SMOOTH
PIL9X102	46	PILASTER FLUTED ADJ PLTH SMOOTH
PIL9X108	46	PILASTER FLUTED ADJ PLTH SMOOTH
PIL9X108P	44	PILASTER PLAIN ADJ PLTH SMOOTH
PIL9X120P	44	PILASTER PLAIN ADJ PLTH SMOOTH
PIL9X144	46	PILASTER FLUTED ADJ PLTH SMOOTH
PIL10X96A	47	PILASTER ARCH PROF SMOOTH
PIL10X96HC	47	PILASTER HALF RND ADJ CLM SMOOTH
PIL10X120P	44	PILASTER PLAIN ADJ PLTH SMOOTH
PIL10X192A	47	PILASTER ARCH PROF SMOOTH
PIL11X90	45	PILASTER FLUTED MLD PLTH SMOOTH
PIL11X90DP	44	PILASTER DOUBLE PANEL MLD PLTH SMOOTH
PIL11X90P	43	PILASTER PLAIN MLD PLTH SMOOTH
PIL11X96P	44	PILASTER PLAIN ADJ PLTH SMOOTH
PIL11X108	46	PILASTER FLUTED ADJ PLTH SMOOTH
PIL11X108DP	44	PILASTER DOUBLE PANEL MLD PLTH SMOOTH
PIL11X108P	44	PILASTER PLAIN ADJ PLTH SMOOTH
PIL11X109P	44	PILASTER PLAIN ADJ PLTH SMOOTH
PIL11X120	46	PILASTER FLUTED ADJ PLTH SMOOTH
PIL11X120P	44	PILASTER PLAIN ADJ PLTH SMOOTH
PIL11X144	46	PILASTER FLUTED ADJ PLTH SMOOTH
PLV18X24-8	185	PEAKED LOUVER DECO SMOOTH
PLV18X36-10	185	PEAKED LOUVER DECO SMOOTH
PLV24X30-10	185	PEAKED LOUVER DECO SMOOTH
PLV24X36-10	185	PEAKED LOUVER DECO SMOOTH
PLV24X36-12	185	PEAKED LOUVER DECO SMOOTH
PP5X102	219	PORCH POST COLONIAL SMOOTH
PP6X108	219	PORCH POST COLONIAL SMOOTH
PP6X120	219	PORCH POST COLONIAL SMOOTH
PP6X96	219	PORCH POST COLONIAL SMOOTH

PART NUMBER	PAGE	DESCRIPTION
PP8X120A	219	PORCH POST COLONIAL SMOOTH
PPSQKIT6X108S	221	COLUMN, TIMBER TEXTURE
PRS48X8	162	PORCH SPANDREL SMOOTH
PRS96X8	162	PORCH SPANDREL SMOOTH
PST10X10F	218	NEWEL POST FLAT POST CAP SMOOTH
PST10X10PST	223	NEWEL POST TOP, STONE TEXTURE
PST11X11FP	216	NEWEL POST FANCY PEAKED CAP SMOOTH
PST13X13F	218	NEWEL POST FLAT POST CAP SMOOTH
PST13X13FP	216	NEWEL POST FANCY PEAKED CAP SMOOTH
PST14X14F	218	NEWEL POST FLAT POST CAP SMOOTH
PST6X6FP	216	NEWEL POST FANCY PEAKED POST CAP SMOOTH
PST7X7F	218	NEWEL POST FLAT POST CAP SMOOTH
PST8X8FP	216	NEWEL POST FANCY PEAKED POST CAP SMOOTH
PST9X9FP	216	NEWEL POST FANCY PEAKED POST CAP SMOOTH
PSTWBASE8S	221	POST WRAP BASE, TIMBER TEXTURE
PSTWCAP8S	221	POST WRAP CAP, TIMBER TEXTURE
PSTWKIT8X96S	221	POST WRAP KIT, TIMBER TEXTURE
R		
RHP56	41	PEDIMENT RAMS HEAD SMOOTH
RHP6100	41	PEDIMENT RAMS HEAD SMOOTH
RHP667	41	PEDIMENT RAMS HEAD SMOOTH
RHP86	41	PEDIMENT RAMS HEAD SMOOTH
RLV12	192	LOUVER DECO ROUND SMOOTH
RLV16	192	LOUVER DECO ROUND SMOOTH
RLV16MTK	193	LOUVER DECO ROUND W/ DC TRIM & KEY SMOOTH
RLV18	192	LOUVER DECO ROUND SMOOTH
RLV18MTK	193	LOUVER DECO ROUND W/ DC TRIM & KEY SMOOTH
RLV18X4F	192	TRIM ROUND SMOOTH
RLV22	192	LOUVER DECO ROUND SMOOTH
RLV24	192	LOUVER DECO ROUND SMOOTH
RLV24-4FTK	193	LOUVER DECO ROUND W/ FL TRIM & KEY SMOOTH
RLV24-6TK	193	LOUVER FUNC ROUND W/ FL TRIM & FLAT KEY SMOOTH
RLV24MTK	193	LOUVER DECO ROUND W/ DC TRIM & KEY SMOOTH
RLV24TK	194	LOUVER DECO ROUND W/ FL TRIM & KEY SMOOTH
RLV24X4F	192	TRIM ROUND SMOOTH
RLV28	192	LOUVER DECO ROUND SMOOTH
RLV28X4F	192	TRIM ROUND SMOOTH
RLV30	192	LOUVER DECO ROUND SMOOTH
RLV30-6TK	193	LOUVER DECO ROUND W/ FL TRIM & KEY SMOOTH
RLV30MTK	193	LOUVER DECO ROUND W/ DC TRIM & KEY SMOOTH
RLV30TK	194	LOUVER DECO ROUND W/ FL TRIM & KEY SMOOTH
RLV32-2F	192	LOUVER DECO ROUND W/ FL TRIM SMOOTH
RLV32MTK	193	LOUVER DECO ROUND W/ DC TRIM & KEY SMOOTH
RLV32TK	194	LOUVER DECO ROUND W/ FL TRIM & KEY SMOOTH
RLV36	192	LOUVER DECO ROUND SMOOTH
RLV36TK	194	LOUVER DECO ROUND W/ FL TRIM & KEY SMOOTH
RLV40MTK	193	LOUVER DECO ROUND W/ DC TRIM & KEY SMOOTH
RLV42	192	LOUVER DECO ROUND SMOOTH
RLV48	192	LOUVER DECO ROUND SMOOTH
RSB4X4X6	212	BAULSTER RAIL SUPPORT BLOCK SMOOTH
S		
S4X21	164	SPIRE SMOOTH
S6X32	164	SPIRE SMOOTH
S8X56	164	SPIRE SMOOTH
SHSFP12X144	59	SHAKER SHUTTER BOARDS 12X144
SHSFP16X144	59	SHAKER SHUTTER BOARDS 16X144
SHSFP18X144	59	SHAKER SHUTTER BOARDS 18X144

PART NUMBER	PAGE	DESCRIPTION
SHSFP24X144	59	SHAKER SHUTTER BOARDS 24X144
SH16X48DP	60	SHUTTER RAISED PANEL DOUBLE SMOOTH
SH16X54DP	60	SHUTTER RAISED PANEL DOUBLE SMOOTH
SH16X60DP	60	SHUTTER RAISED PANEL DOUBLE SMOOTH
SH16X65DP	60	SHUTTER RAISED PANEL DOUBLE SMOOTH
SH16X72DP	60	SHUTTER RAISED PANEL DOUBLE SMOOTH
SH18X53DP	60	SHUTTER RAISED PANEL DOUBLE SMOOTH
SH18X59DP	60	SHUTTER RAISED PANEL DOUBLE SMOOTH
SH18X66DP	60	SHUTTER RAISED PANEL DOUBLE SMOOTH
SH18X72DP	60	SHUTTER RAISED PANEL DOUBLE SMOOTH
SHAKER SHUTTER 12"		
SH2FP12X__	59	SHAKER SHUTTER
SHAKER SHUTTER 16"		
SH2FP16X__	59	SHAKER SHUTTER
SHAKER SHUTTER 18"		
SH2FP18X__	59	SHAKER SHUTTER
SHAKER SHUTTER 24"		
SH2FP24X__	59	SHAKER SHUTTER
PLANK, 2 PLANK, 3 BATTEN 12"		
SH2P3B12X24RS	70	SHUTTER 2 PLANK 3 BATTEN, ROUGH SAWN WOODGRAIN
SH2P3B12X36RS	70	SHUTTER 2 PLANK 3 BATTEN, ROUGH SAWN WOODGRAIN
SH2P3B12X48RS	70	SHUTTER 2 PLANK 3 BATTEN, ROUGH SAWN WOODGRAIN
SH2P3B12X60RS	70	SHUTTER 2 PLANK 3 BATTEN, ROUGH SAWN WOODGRAIN
SH2P3B12X72RS	70	SHUTTER 2 PLANK 3 BATTEN, ROUGH SAWN WOODGRAIN
SH2P3B12X84RS	70	SHUTTER 2 PLANK 3 BATTEN, ROUGH SAWN WOODGRAIN
SH2P3B12X96RS	70	SHUTTER 2 PLANK 3 BATTEN, ROUGH SAWN WOODGRAIN
SH2P3B12X108RS	70	SHUTTER 2 PLANK 3 BATTEN, ROUGH SAWN WOODGRAIN
SH2P3B12X120RS	70	SHUTTER 2 PLANK 3 BATTEN, ROUGH SAWN WOODGRAIN
B&B 2 BOARD, 3 BATTEN 12"		
SH2P3BC12X24RS	64	SHUTTER 2 BOARD AND 3 BATTEN, ROUGH SAWN WOODGRAIN
SH2P3BC12X36RS	64	SHUTTER 2 BOARD AND 3 BATTEN, ROUGH SAWN WOODGRAIN
SH2P3BC12X48RS	64	SHUTTER 2 BOARD AND 3 BATTEN, ROUGH SAWN WOODGRAIN
SH2P3BC12X60RS	64	SHUTTER 2 BOARD AND 3 BATTEN, ROUGH SAWN WOODGRAIN
SH2P3BC12X72RS	64	SHUTTER 2 BOARD AND 3 BATTEN, ROUGH SAWN WOODGRAIN
SH2P3BC12X84RS	64	SHUTTER 2 BOARD AND 3 BATTEN, ROUGH SAWN WOODGRAIN
SH2P3BC12X96RS	64	SHUTTER 2 BOARD AND 3 BATTEN, ROUGH SAWN WOODGRAIN
SH2P3BC12X108RS	64	SHUTTER 2 BOARD AND 3 BATTEN, ROUGH SAWN WOODGRAIN
SH2P3BC12X120RS	64	SHUTTER 2 BOARD AND 3 BATTEN, ROUGH SAWN WOODGRAIN
B&B 2 BOARD, 2 BATTEN 12"		
SH2PC12X24RS	64	SHUTTER 2 BOARD AND BATTEN, ROUGH SAWN WOODGRAIN
SH2PC12X36RS	64	SHUTTER 2 BOARD AND BATTEN, ROUGH SAWN WOODGRAIN
SH2PC12X48RS	64	SHUTTER 2 BOARD AND BATTEN, ROUGH SAWN WOODGRAIN
SH2PC12X60RS	64	SHUTTER 2 BOARD AND BATTEN, ROUGH SAWN WOODGRAIN
SH2PC12X72RS	64	SHUTTER 2 BOARD AND BATTEN, ROUGH SAWN WOODGRAIN
SH2PC12X84RS	64	SHUTTER 2 BOARD AND BATTEN, ROUGH SAWN WOODGRAIN
SH2PC12X96RS	64	SHUTTER 2 BOARD AND BATTEN, ROUGH SAWN WOODGRAIN
SH2PC12X108RS	64	SHUTTER 2 BOARD AND BATTEN, ROUGH SAWN WOODGRAIN
SH2PC12X120RS	64	SHUTTER 2 BOARD AND BATTEN, ROUGH SAWN WOODGRAIN
PLANK, 2 PLANK, DIAMOND 12"		
SH2PD12X24RS	74	SHUTTER 2 PLANK W/DIAMOND, ROUGH SAWN WOODGRAIN
SH2PD12X36RS	74	SHUTTER 2 PLANK W/DIAMOND, ROUGH SAWN WOODGRAIN
SH2PD12X48RS	74	SHUTTER 2 PLANK W/DIAMOND, ROUGH SAWN WOODGRAIN
SH2PD12X60RS	74	SHUTTER 2 PLANK W/DIAMOND, ROUGH SAWN WOODGRAIN
SH2PD12X72RS	74	SHUTTER 2 PLANK W/DIAMOND, ROUGH SAWN WOODGRAIN
SH2PD12X84RS	74	SHUTTER 2 PLANK W/DIAMOND, ROUGH SAWN WOODGRAIN
SH2PD12X96RS	74	SHUTTER 2 PLANK W/DIAMOND, ROUGH SAWN WOODGRAIN
SH2PD12X108RS	74	SHUTTER 2 PLANK W/DIAMOND, ROUGH SAWN WOODGRAIN





PART NUMBER	PAGE	DESCRIPTION
SH4PC24X84RS	69	SHUTTER 4 BOARD AND BATTEN, ROUGH SAWN WOODGRAIN
SH4PC24X96RS	69	SHUTTER 4 BOARD AND BATTEN, ROUGH SAWN WOODGRAIN
SH4PC24X108RS	69	SHUTTER 4 BOARD AND BATTEN, ROUGH SAWN WOODGRAIN
SH4PC24X120RS	69	SHUTTER 4 BOARD AND BATTEN, ROUGH SAWN WOODGRAIN
PLANK, 4 PLANK 3 BATTEN 24"		
SH4PD24X24RS	74	SHUTTER 4 PLANK W/DIAMOND, ROUGH SAWN WOODGRAIN
SH4PD24X36RS	74	SHUTTER 4 PLANK W/DIAMOND, ROUGH SAWN WOODGRAIN
SH4PD24X48RS	74	SHUTTER 4 PLANK W/DIAMOND, ROUGH SAWN WOODGRAIN
SH4PD24X60RS	74	SHUTTER 4 PLANK W/DIAMOND, ROUGH SAWN WOODGRAIN
SH4PD24X72RS	74	SHUTTER 4 PLANK W/DIAMOND, ROUGH SAWN WOODGRAIN
SH4PD24X84RS	74	SHUTTER 4 PLANK W/DIAMOND, ROUGH SAWN WOODGRAIN
SH4PD24X96RS	74	SHUTTER 4 PLANK W/DIAMOND, ROUGH SAWN WOODGRAIN
SH4PD24X108RS	74	SHUTTER 4 PLANK W/DIAMOND, ROUGH SAWN WOODGRAIN
SH4PD24X120RS	74	SHUTTER 4 PLANK W/DIAMOND, ROUGH SAWN WOODGRAIN
B&B 4 BOARD, END BATTEN 24"		
SH4PEBC24X24RS	69	SHUTTER 4 BOARD AND END BATTEN, ROUGH SAWN WOODGRAIN
SH4PEBC24X36RS	69	SHUTTER 4 BOARD AND END BATTEN, ROUGH SAWN WOODGRAIN
SH4PEBC24X48RS	69	SHUTTER 4 BOARD AND END BATTEN, ROUGH SAWN WOODGRAIN
SH4PEBC24X60RS	69	SHUTTER 4 BOARD AND END BATTEN, ROUGH SAWN WOODGRAIN
SH4PEBC24X72RS	69	SHUTTER 4 BOARD AND END BATTEN, ROUGH SAWN WOODGRAIN
SH4PEBC24X84RS	69	SHUTTER 4 BOARD AND END BATTEN, ROUGH SAWN WOODGRAIN
SH4PEBC24X96RS	69	SHUTTER 4 BOARD AND END BATTEN, ROUGH SAWN WOODGRAIN
SH4PEBC24X108RS	69	SHUTTER 4 BOARD AND END BATTEN, ROUGH SAWN
SH4PEBC24X120RS	69	SHUTTER 4 BOARD AND END BATTEN, ROUGH SAWN
B&B 4 BOARD, QUARTER ROUND 2 BATTEN 24"		
SH4PHLR24X48RS	69	SHUTTER 4 ARCH TOP BOARD AND BATTEN, ROUGH SAWN
SH4PHLR24X60RS	69	SHUTTER 4 ARCH TOP BOARD AND BATTEN, ROUGH SAWN
SH4PHLR24X72RS	69	SHUTTER 4 ARCH TOP BOARD AND BATTEN, ROUGH SAWN
SH4PHLR24X84RS	69	SHUTTER 4 ARCH TOP BOARD AND BATTEN, ROUGH SAWN
SH4PHLR24X96RS	69	SHUTTER 4 ARCH TOP BOARD AND BATTEN, ROUGH SAWN
SH4PHLR24X108RS	69	SHUTTER 4 ARCH TOP BOARD AND BATTEN, ROUGH SAWN
SH4PHLR24X120RS	69	SHUTTER 4 ARCH TOP BOARD AND BATTEN, ROUGH SAWN
PLANK, 4 PLANK 2 BATTEN 24"		
SH4P024X24RS	71	SHUTTER 4 PLANK, ROUGH SAWN WOODGRAIN
SH4P024X36RS	71	SHUTTER 4 PLANK, ROUGH SAWN WOODGRAIN
SH4P024X48RS	71	SHUTTER 4 PLANK, ROUGH SAWN WOODGRAIN
SH4P024X60RS	71	SHUTTER 4 PLANK, ROUGH SAWN WOODGRAIN
SH4P024X72RS	71	SHUTTER 4 PLANK, ROUGH SAWN WOODGRAIN
SH4P024X84RS	71	SHUTTER 4 PLANK, ROUGH SAWN WOODGRAIN
SH4P024X96RS	71	SHUTTER 4 PLANK, ROUGH SAWN WOODGRAIN
SH4P024X108RS	71	SHUTTER 4 PLANK, ROUGH SAWN WOODGRAIN
SH4P024X120RS	71	SHUTTER 4 PLANK, ROUGH SAWN WOODGRAIN
PLANK, 4 PLANK Z BATTEN 24"		
SH4PZ24X24RS	71	SHUTTER 4 PLANK, ROUGH SAWN WOODGRAIN
SH4PZ24X36RS	71	SHUTTER 4 PLANK, ROUGH SAWN WOODGRAIN
SH4PZ24X48RS	71	SHUTTER 4 PLANK, ROUGH SAWN WOODGRAIN
SH4PZ24X60RS	71	SHUTTER 4 PLANK, ROUGH SAWN WOODGRAIN
SH4PZ24X72RS	71	SHUTTER 4 PLANK, ROUGH SAWN WOODGRAIN
SH4PZ24X84RS	71	SHUTTER 4 PLANK, ROUGH SAWN WOODGRAIN
SH4PZ24X96RS	71	SHUTTER 4 PLANK, ROUGH SAWN WOODGRAIN
SH4PZ24X108RS	71	SHUTTER 4 PLANK, ROUGH SAWN WOODGRAIN
SH4PZ24X120RS	71	SHUTTER 4 PLANK, ROUGH SAWN WOODGRAIN
B&B 4 BOARD, Z BATTEN 24"		
SH4PZC24X24RS	69	SHUTTER 4 BOARD AND Z-BATTEN, ROUGH SAWN WOODGRAIN
SH4PZC24X36RS	69	SHUTTER 4 BOARD AND Z-BATTEN, ROUGH SAWN WOODGRAIN
SH4PZC24X48RS	69	SHUTTER 4 BOARD AND Z-BATTEN, ROUGH SAWN WOODGRAIN
SH4PZC24X60RS	69	SHUTTER 4 BOARD AND Z-BATTEN, ROUGH SAWN WOODGRAIN

PART NUMBER	PAGE	DESCRIPTION
SH4PZC24X72RS	69	SHUTTER 4 BOARD AND Z-BATTEN, ROUGH SAWN WOODGRAIN
SH4PZC24X84RS	69	SHUTTER 4 BOARD AND Z-BATTEN, ROUGH SAWN WOODGRAIN
SH4PZC24X96RS	69	SHUTTER 4 BOARD AND Z-BATTEN, ROUGH SAWN WOODGRAIN
SH4PZC24X108RS	69	SHUTTER 4 BOARD AND Z-BATTEN, ROUGH SAWN WOODGRAIN
SH4PZC24X120RS	69	SHUTTER 4 BOARD AND Z-BATTEN, ROUGH SAWN WOODGRAIN
SHUTTER BOARDS		
SHBB12X144RS	77	SHUTTER BOARD 2 BOARD, WOODGRAIN
SHBB12X144RS-CP	77	SHUTTER BOARD 2 BOARD, WOODGRAIN CONTRACTOR
SHBB14X144RS	77	SHUTTER BOARD 3 BOARD, WOODGRAIN
SHBB14X144RS-CP	77	SHUTTER BOARD 3 BOARD, WOODGRAIN CONTRACTOR
SHBB18X144RS	77	SHUTTER BOARD 3 BOARD, WOODGRAIN
SHBB18X144RS-CP	77	SHUTTER BOARD 3 BOARD, WOODGRAIN CONTRACTOR
SHBB24X144RS	77	SHUTTER BOARD 4 BOARD, WOODGRAIN
SHBB24X144RS-CP	77	SHUTTER BOARD 4 BOARD, WOODGRAIN CONTRACTOR
B&B & PLANK SHUTTER ACCESSORIES		
SHCLAPYR1.25	75	SHUTTER CLAVOS PYRAMID STYLE
SHCLAPYR1.25-100PACK	75	SHUTTER CLAVOS PYRAMID STYLE 1.25IN. (QTY 100)
SHCLAPYR1.25-12PACK	75	SHUTTER CLAVOS PYRAMID STYLE 1.25IN. (QTY 12)
SHCLAPYR1.25-18PACK	75	SHUTTER CLAVOS PYRAMID STYLE 1.25IN. (QTY 18)
SHCLAPYR1.25-24PACK	75	SHUTTER CLAVOS PYRAMID STYLE 1.25IN. (QTY 24)
SHCLAPYR1.25-8PACK	75	SHUTTER CLAVOS PYRAMID STYLE 1.25IN. (QTY 8)
SHCLARND1.25	75	SHUTTER CLAVOS ROUND STYLE
SHCLARND1.25-100PACK	75	SHUTTER CLAVOS ROUND STYLE 1.25IN. (QTY 100)
SHCLARND1.25-12PACK	75	SHUTTER CLAVOS ROUND STYLE 1.25IN (QTY 12)
SHCLARND1.25-18PACK	75	SHUTTER CLAVOS ROUND STYLE 1.25IN (QTY 18)
SHCLARND1.25-24PACK	75	SHUTTER CLAVOS PYRAMID STYLE 1.25IN. (QTY 24)
SHCLARND1.25-8PACK	75	SHUTTER CLAVOS ROUND STYLE 1.25IN (QTY 8)
SHHNGCOL10	75	SHUTTER HINGE COLONIAL STYLE
SHHNGCOL16	75	SHUTTER HINGE COLONIAL STYLE
SHHNGSPR10	75	SHUTTER HINGE SPEAR STYLE
SHHNGSPR16	75	SHUTTER HINGE SPEAR STYLE
SHAKER MODERN FARMHOUSE 12"		
SHMFH12X__	58	SHAKER MODERN FARMHOUSE SHUTTER
SHAKER MODERN FARMHOUSE 16"		
SHMFH16X__	58	SHAKER MODERN FARMHOUSE SHUTTER
SHAKER MODERN FARMHOUSE 18"		
SHMFH18X__	58	SHAKER MODERN FARMHOUSE SHUTTER
SHAKER MODERN FARMHOUSE 24"		
SHMFH24X__	58	SHAKER MODERN FARMHOUSE SHUTTER
SP56	36	PEDIMENT SUNBURST SMOOTH
SP86	36	PEDIMENT SUNBURST SMOOTH
SP91	36	PEDIMENT SUNBURST SMOOTH
SP667	36	PEDIMENT SUNBURST SMOOTH
STRPOSTKIT96	228	STRUCTURAL POST, 96"
STRPOSTKIT108	228	STRUCTURAL POST, 108"
STRPOSTKIT120	228	STRUCTURAL POST, 120"
SWDH24X12	35	PEDIMENT HALF ROUND SUNBURST SMOOTH
SWDH28X14	35	PEDIMENT HALF ROUND SUNBURST SMOOTH
SWDH30X15	35	PEDIMENT HALF ROUND SUNBURST SMOOTH
SWDH32X16	35	PEDIMENT HALF ROUND SUNBURST SMOOTH
SWDH33X17	35	PEDIMENT HALF ROUND SUNBURST SMOOTH
SWDH36X18	35	PEDIMENT HALF ROUND SUNBURST SMOOTH
SWDH36X18-4FK	36	PEDIMENT HALF RND SUNBURST W/FLT TRIM & KEY SMOOTH
SWDH36X9	34	PEDIMENT SEGMENT SUNBURST SMOOTH
SWDH37X19	35	PEDIMENT HALF ROUND SUNBURST SMOOTH
SWDH40X10	34	PEDIMENT SEGMENT SUNBURST SMOOTH
SWDH40X20	35	PEDIMENT HALF ROUND SUNBURST SMOOTH

PART NUMBER	PAGE	DESCRIPTION
SWDH42X21	35	PEDIMENT HALF ROUND SUNBURST SMOOTH
SWDH44X22	35	PEDIMENT HALF ROUND SUNBURST SMOOTH
SWDH48X13	34	PEDIMENT SEGMENT SUNBURST SMOOTH
SWDH48X24	35	PEDIMENT HALF ROUND SUNBURST SMOOTH
SWDH56X28	35	PEDIMENT HALF ROUND SUNBURST SMOOTH
SWDH60X30	35	PEDIMENT HALF ROUND SUNBURST SMOOTH
SWDH64X32	35	PEDIMENT HALF ROUND SUNBURST SMOOTH
SWDH68X14	34	PEDIMENT SEGMENT SUNBURST SMOOTH
SWDH68X34	35	PEDIMENT HALF ROUND SUNBURST SMOOTH
SWDH72X14	34	PEDIMENT SEGMENT SUNBURST SMOOTH
SWDH72X36	35	PEDIMENT HALF ROUND SUNBURST SMOOTH
SWDH76X15	34	PEDIMENT SEGMENT SUNBURST SMOOTH
SWDH76X38	35	PEDIMENT HALF ROUND SUNBURST SMOOTH
SWDH80X15	34	PEDIMENT SEGMENT SUNBURST SMOOTH
SWDH100X50	35	PEDIMENT HALF ROUND SUNBURST SMOOTH
T		
TC6	218	NEWEL POST TRIM COLLAR SMOOTH
TC8	218	NEWEL POST TRIM COLLAR SMOOTH
TC8-8	218	NEWEL POST TRIM COLLAR SMOOTH
TRLS18987	161	TRELLIS KIT, TIMBER TEXTURE, INSTALLED
TRLS18988	161	TRELLIS KIT, TIMBER TEXTURE, INSTALLED
TRLS18989	160,161	TRELLIS HARDWARE KIT
TRLS18994	160,161	TRELLIS HARDWARE KIT
TRLS19003	160	TRELLIS KIT SMOOTH
TRLS19004	160	TRELLIS KIT SMOOTH
TRLV36X18	196	TRIANGLE LOUVER DECO SMOOTH
TRLV42X21	196	TRIANGLE LOUVER DECO SMOOTH
TRLV48X12	196	TRIANGLE LOUVER DECO SMOOTH
TRLV48X18	196	TRIANGLE LOUVER DECO SMOOTH
TRLV48X22	196	TRIANGLE LOUVER DECO SMOOTH
TRLV48X24	196	TRIANGLE LOUVER DECO SMOOTH
TRLV60X18	196	TRIANGLE LOUVER DECO SMOOTH
TRLV60X23	196	TRIANGLE LOUVER DECO SMOOTH
TRLV60X25	196	TRIANGLE LOUVER DECO SMOOTH
TRLV60X30	196	TRIANGLE LOUVER DECO SMOOTH
TRLV64X27	196	TRIANGLE LOUVER DECO SMOOTH
TRLV64X32	196	TRIANGLE LOUVER DECO SMOOTH
TRLV66X22	196	TRIANGLE LOUVER DECO SMOOTH
TRLV72X36	196	TRIANGLE LOUVER DECO SMOOTH
TRLV76X19	196	TRIANGLE LOUVER DECO SMOOTH
TRLV84X18	196	TRIANGLE LOUVER DECO SMOOTH
TRLV84X21	196	TRIANGLE LOUVER DECO SMOOTH
TRLV88X22	196	TRIANGLE LOUVER DECO SMOOTH
TRLVLR60X25	197	2PC TRIANGLE LOUVER DECO SMOOTH
TRLVLR60X30	197	2PC TRIANGLE LOUVER DECO SMOOTH
TRLVLR108X27	197	2PC TRIANGLE LOUVER DECO SMOOTH
TRLVLR115X35	197	2PC TRIANGLE LOUVER DECO SMOOTH
TRLVLR120X30	197	2PC TRIANGLE LOUVER DECO SMOOTH
TV20X20-3FR	163	TILE VENT, SMOOTH, 3 HOLE FULL ROUND
W		
6" Crosshead		
WCH24X6	27	CROSSHEAD SMOOTH
WCH24X6D	27	CROSSHEAD W/DT SMOOTH
WCH24X6K	27	CROSSHEAD W/KEY SMOOTH
WCH24X6T	27	CROSSHEAD W/TS SMOOTH
WCH24X7BT	27	CROSSHEAD W/BT SMOOTH
WCH28X6	27	CROSSHEAD SMOOTH

PART NUMBER	PAGE	DESCRIPTION
WCH28X6D	27	CROSSHEAD W/DT SMOOTH
WCH28X6K	27	CROSSHEAD W/KEY SMOOTH
WCH28X6T	27	CROSSHEAD W/TS SMOOTH
WCH28X7BT	27	CROSSHEAD W/BT SMOOTH
WCH30X6	27	CROSSHEAD SMOOTH
WCH30X6D	27	CROSSHEAD W/DT SMOOTH
WCH30X6K	27	CROSSHEAD W/KEY SMOOTH
WCH30X6T	27	CROSSHEAD W/TS SMOOTH
WCH30X7BT	27	CROSSHEAD W/BT SMOOTH
WCH31X6	27	CROSSHEAD SMOOTH
WCH31X6D	27	CROSSHEAD W/DT SMOOTH
WCH31X6K	27	CROSSHEAD W/KEY SMOOTH
WCH31X6T	27	CROSSHEAD W/TS SMOOTH
WCH31X7BT	27	CROSSHEAD W/BT SMOOTH
WCH32X6	27	CROSSHEAD SMOOTH
WCH32X6D	27	CROSSHEAD W/DT SMOOTH
WCH32X6K	27	CROSSHEAD W/KEY SMOOTH
WCH32X6T	27	CROSSHEAD W/TS SMOOTH
WCH32X7BT	27	CROSSHEAD W/BT SMOOTH
WCH33X6	27	CROSSHEAD SMOOTH
WCH33X6D	27	CROSSHEAD W/DT SMOOTH
WCH33X6K	27	CROSSHEAD W/KEY SMOOTH
WCH33X6T	27	CROSSHEAD W/TS SMOOTH
WCH33X7BT	27	CROSSHEAD W/BT SMOOTH
WCH34X6	27	CROSSHEAD SMOOTH
WCH34X6D	27	CROSSHEAD W/DT SMOOTH
WCH34X6K	27	CROSSHEAD W/KEY SMOOTH
WCH34X6T	27	CROSSHEAD W/TS SMOOTH
WCH34X7BT	27	CROSSHEAD W/BT SMOOTH
WCH35X6	27	CROSSHEAD SMOOTH
WCH35X6D	27	CROSSHEAD W/DT SMOOTH
WCH35X6K	27	CROSSHEAD W/KEY SMOOTH
WCH35X6T	27	CROSSHEAD W/TS SMOOTH
WCH35X7BT	27	CROSSHEAD W/BT SMOOTH
WCH36X6	27	CROSSHEAD SMOOTH
WCH36X6D	27	CROSSHEAD W/DT SMOOTH
WCH36X6K	27	CROSSHEAD W/KEY SMOOTH
WCH36X6T	27	CROSSHEAD W/TS SMOOTH
WCH36X7BT	27	CROSSHEAD W/BT SMOOTH
WCH37X6	27	CROSSHEAD SMOOTH
WCH37X6D	27	CROSSHEAD W/DT SMOOTH
WCH37X6K	27	CROSSHEAD W/KEY SMOOTH
WCH37X6T	27	CROSSHEAD W/TS SMOOTH
WCH37X7BT	27	CROSSHEAD W/BT SMOOTH
WCH38X6	27	CROSSHEAD SMOOTH
WCH38X6D	27	CROSSHEAD W/DT SMOOTH
WCH38X6K	27	CROSSHEAD W/KEY SMOOTH
WCH38X6T	27	CROSSHEAD W/TS SMOOTH
WCH38X7BT	27	CROSSHEAD W/BT SMOOTH
WCH40X6	27	CROSSHEAD SMOOTH
WCH40X6D	27	CROSSHEAD W/DT SMOOTH
WCH40X6K	27	CROSSHEAD W/KEY SMOOTH
WCH40X6T	27	CROSSHEAD W/TS SMOOTH
WCH40X7BT	27	CROSSHEAD W/BT SMOOTH
WCH41X6	27	CROSSHEAD SMOOTH
WCH41X6D	27	CROSSHEAD W/DT SMOOTH
WCH41X6K	27	CROSSHEAD W/KEY SMOOTH













1750 Indian Wood Circle | Maumee, OH 43537 | Phone: 800.446.3040 U.S. and Canada  
Fax: 800.446.9373 U.S. and Canada | [www.fypon.com](http://www.fypon.com) | [info@fypon.com](mailto:info@fypon.com)



Fypon warrants all of our products to be free from defects in material and workmanship for as long as the original owner of the residential dwelling owns the property.  
For complete homeowner lifetime limited warranty details, exclusions and limitations, please see your purchase location or visit [www.fypon.com](http://www.fypon.com).